







0 0301 0022992 6



*ELEMENTS OF*  
Acoustical Engineering



530  
ll 8  
a

# *ELEMENTS OF* Acoustical Engineering

By

HARRY F. OLSON, E.E., PH.D.

*Acoustic Research Director  
RCA Manufacturing Company*

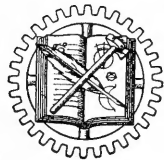

NEW YORK  
D. VAN NOSTRAND COMPANY, INC.  
250 FOURTH AVENUE  
1940

Copyright, 1940, by  
D. VAN NOSTRAND COMPANY, INC.

---

*All Rights Reserved*

*This book, or any parts thereof, may  
not be reproduced in any form without  
written permission from the publishers*



## PREFACE

The reproduction of sound is so commonplace to-day that it is taken for granted by the layman. Nevertheless, the developments during the past two decades in the arts of communications and sound reproduction have been remarkable. In the early stages of the present epoch of progress the advances were made by pure scientists. As in the metamorphosis of any art, the burden has been gradually shifted to the applied scientist and engineer. These changes have led to a demand for expositions upon the fundamental principles of the new applied science of acoustics from the standpoint of the engineer. Accordingly, this book has been written with the idea of presenting the elements and principles of acoustics to the engineer.

This text is the subject matter of thirty lectures prepared for presentation at Columbia University. It is an exposition of the fundamental principles used in modern acoustics and a description of the existing acoustical instruments. Particular efforts have been directed towards the development of analogies between electrical, mechanical and acoustical systems, because engineers have found that the reduction of a vibrating system to the equivalent electrical circuit is a valuable aid in the analysis of vibrating systems. These methods will become increasingly important as the front of engineering acoustics is broadened. As an aid to the establishment of these analogies an attempt has been made to depict a complete theme in each illustration.

The book includes the current acoustic practices in radio, phonograph, sound motion pictures, public address, sound re-enforcing and sound measurements. Practically all modern transducers such as microphones, loud speakers, headphones and phonograph pickups are treated from the mechanical or the acoustical impedance viewpoint.

A knowledge of acoustics principles is not required for an understanding of the subject matter. The text may be read and understood by anyone familiar with the principles of elementary physics and simple electric circuit theory.

The author wishes to express his gratitude to his wife, Lorene E. Olson, for assistance in the compilation, preparation and correction of the manuscript.

## PREFACE

The author wishes to acknowledge the interest given by Messrs. L. M. Clement, Vice President, and E. W. Engstrom, Research Director, of the RCA Manufacturing Company, in this project.

HARRY F. OLSON

JANUARY, 1940

## CONTENTS

CHAPTER	PAGE
<b>I. SOUND WAVES</b>	
1.1 INTRODUCTION . . . . .	1
1.2 SOUND WAVES . . . . .	2
1.3 ACOUSTIC WAVE EQUATION . . . . .	4
A. Equation of Continuity . . . . .	4
B. Equation of Motion . . . . .	5
C. Compressibility of a Gas . . . . .	5
D. Condensation . . . . .	6
E. D'Alembertian Wave Equation . . . . .	6
1.4 PLANE WAVES . . . . .	7
A. Particle Velocity in a Plane Wave . . . . .	9
B. Pressure in a Plane Wave . . . . .	9
C. Particle Amplitude in a Plane Wave . . . . .	9
1.5 SPHERICAL WAVES . . . . .	10
A. Pressure in a Spherical Wave . . . . .	11
B. Particle Velocity in a Spherical Wave . . . . .	12
C. Phase Angle Between the Pressure and the Particle Velocity in a Spherical Wave . . . . .	12
D. Ratio of the Absolute Magnitudes of the Particle Velocity and the Pressure in a Spherical Sound Wave . . . . .	13
1.6 STATIONARY WAVES . . . . .	13
1.7 SOUND ENERGY DENSITY . . . . .	14
1.8 SOUND INTENSITY . . . . .	14
1.9 DECIBELS (BELS) . . . . .	15
1.10 DOPPLER EFFECT . . . . .	16
1.11 REFRACTION AND DIFFRACTION . . . . .	17
<b>II. ACOUSTICAL RADIATING SYSTEMS</b>	
2.1 INTRODUCTION . . . . .	19
2.2 SIMPLE POINT SOURCE . . . . .	19
A. Point Source Radiating into an Infinite Medium Solid Angle of $4\pi$ Steradians . . . . .	19
B. Point Source Radiating into a Semi-Infinite Medium Solid Angle of $2\pi$ Steradians . . . . .	20
C. Point Source Radiating into a Solid Angle of $\pi$ Steradians . . . . .	20
D. Point Source Radiating into a Solid Angle of $\pi/2$ Steradians . . . . .	20
E. Application of the Simple Source . . . . .	20

CHAPTER	PAGE	
2.3	DOUBLE SOURCE (DOUBLET SOURCE) . . . . .	21
2.4	STRAIGHT LINE SOURCE . . . . .	24
2.5	CURVED LINE SOURCE (ARC OF A CIRCLE) . . . . .	25
2.6	CIRCULAR RING SOURCE . . . . .	28
2.7	PLANE CIRCULAR SURFACE SOURCE . . . . .	29
2.8	EXPONENTIAL HORNS . . . . .	31
2.9	CURVED SURFACE SOURCE . . . . .	32
 III. MECHANICAL VIBRATING SYSTEMS		
3.1	INTRODUCTION . . . . .	36
3.2	STRINGS . . . . .	36
3.3	TRANSVERSE VIBRATIONS OF BARS . . . . .	38
	A. Bar Clamped at One End . . . . .	38
	B. Bar Free at Both Ends . . . . .	39
	C. Bar Clamped at Both Ends . . . . .	40
	D. Bar Supported at Both Ends . . . . .	40
3.4	CIRCULAR MEMBRANE . . . . .	40
3.5	CIRCULAR CLAMPED PLATE . . . . .	42
3.6	LONGITUDINAL VIBRATION OF BARS . . . . .	44
3.7	TORSIONAL VIBRATION OF BARS . . . . .	46
3.8	OPEN AND CLOSED PIPES . . . . .	47
 IV. ELECTRICAL, MECHANICAL AND ACOUSTICAL ANALOGIES		
4.1	INTRODUCTION . . . . .	49
4.2	RESISTANCE . . . . .	49
	A. Electrical Resistance . . . . .	49
	B. Mechanical Resistance . . . . .	50
	C. Acoustical Resistance . . . . .	50
4.3	INDUCTANCE, INERTIA, INERTANCE . . . . .	50
	A. Inductance . . . . .	50
	B. Inertia . . . . .	51
	C. Inertness . . . . .	51
4.4	CAPACITANCE, COMPLIANCE, ACOUSTIC CAPACITANCE . . . . .	51
	A. Electrical Capacitance . . . . .	51
	B. Mechanical Compliance . . . . .	52
	C. Acoustical Capacitance . . . . .	52
4.5	REPRESENTATION OF ELECTRICAL, MECHANICAL AND ACOUSTICAL ELEMENTS . . . . .	53
4.6	ELECTRICAL, MECHANICAL AND ACOUSTICAL SYSTEMS OF ONE DEGREE OF FREEDOM . . . . .	54
	A. Kinetic Energy . . . . .	55
	B. Potential Energy . . . . .	55
	C. Dissipation . . . . .	56
	D. Equations of Motion . . . . .	57
	E. Resonant Frequency . . . . .	59

# CONTENTS

ix

CHAPTER	PAGE
4.7 ELECTRICAL, MECHANICAL AND ACOUSTICAL SYSTEMS OF TWO DEGREES OF FREEDOM . . . . .	60
4.8 ELECTRICAL, MECHANICAL AND ACOUSTICAL SYSTEMS OF THREE DEGREES OF FREEDOM . . . . .	61
4.9 CORRECTIVE NETWORKS . . . . .	62
A. Introduction . . . . .	62
B. Inductance in Shunt with a Line and the Mechanical and Acoustical Equivalents . . . . .	62
C. Capacitance in Shunt with a Line and the Mechanical and Acoustical Equivalents . . . . .	63
D. Inductance and Capacitance in Series, in Shunt with a Line and the Mechanical and Acoustical Equivalents . . . . .	64
E. Inductance and Capacitance in Parallel, in Shunt with a Line and the Mechanical and Acoustical Equivalents . . . . .	64
F. Inductance in Series with a Line and the Mechanical and Acoustical Equivalents . . . . .	65
G. Capacitance in Series with a Line and the Mechanical and Acoustical Equivalents . . . . .	65
H. Inductance and Capacitance in Series, in Series with a Line and the Mechanical and Acoustical Equivalents . . . . .	67
I. Inductance and Capacitance in Parallel, in Series with a Line and the Mechanical and Acoustical Equivalents . . . . .	67
J. Resistance in Series with a Line and the Mechanical and Acoustical Equivalents . . . . .	67
K. Resistance in Shunt with a Line and the Mechanical and Acoustical Equivalents . . . . .	68
L. "T" Type Resistance Network and the Mechanical and Acoustical Equivalents . . . . .	69
M. " $\pi$ " Type Resistance Network and the Mechanical and Acoustical Equivalents . . . . .	69
4.10 WAVE FILTERS . . . . .	69
A. Introduction . . . . .	69
B. Types of Wave Filters . . . . .	69
C. Response Frequency Characteristics of Wave Filters . . . . .	70
D. Low Pass Wave Filters . . . . .	70
E. High Pass Wave Filters . . . . .	72
F. Band Pass Wave Filters . . . . .	73
G. Band Elimination Wave Filters . . . . .	74
4.11 SUMMARY OF ELECTRICAL, MECHANICAL AND ACOUSTICAL ANALOGIES . . . . .	75
<b>V. ACOUSTICAL ELEMENTS</b>	
5.1 INTRODUCTION . . . . .	77
5.2 ACOUSTIC RESISTANCE . . . . .	77
5.3 ACOUSTIC IMPEDANCE OF A TUBE OF SMALL DIAMETER . . . . .	78
5.4 ACOUSTIC IMPEDANCE OF A NARROW SLIT . . . . .	78

CHAPTER	PAGE
5.5 INERTANCE . . . . .	79
5.6 ACOUSTIC CAPACITANCE . . . . .	79
5.7 RESISTIVE AND REACTIVE LOAD UPON A VIBRATING PISTON . . . . .	80
5.8 RESISTIVE AND REACTIVE LOAD UPON A PULSATING SPHERE . . . . .	81
5.9 RESISTIVE AND REACTIVE AIR LOAD UPON AN OSCILLATING SPHERE . . . . .	83
5.10 IMPEDANCE OF A CIRCULAR ORIFICE IN A WALL OF INFINITESIMAL THICKNESS . . . . .	84
5.11 IMPEDANCE OF AN OPEN PIPE WITH LARGE FLANGES . . . . .	84
5.12 CLOSED PIPE WITH A FLANGE . . . . .	84
5.13 HORNS . . . . .	85
5.14 FUNDAMENTAL HORN EQUATION . . . . .	86
5.15 INFINITE PARABOLIC HORN . . . . .	87
5.16 INFINITE CONICAL HORN . . . . .	88
5.17 INFINITE EXPONENTIAL HORN . . . . .	89
5.18 THROAT IMPEDANCE CHARACTERISTICS OF INFINITE PARABOLIC, CONICAL AND EXPONENTIAL HORNS . . . . .	89
5.19 FINITE CONICAL HORNS . . . . .	90
5.20 FINITE EXPONENTIAL HORNS . . . . .	91
5.21 THROAT IMPEDANCE CHARACTERISTICS OF FINITE EXPONENTIAL HORNS . . . . .	92
5.22 EXPONENTIAL CONNECTORS . . . . .	94
5.23 A HORN CONSISTING OF MANIFOLD EXPONENTIAL SECTIONS . . . . .	96
5.24 SOUND TRANSMISSION IN TUBES . . . . .	97
5.25 TRANSMISSION OF SOUND FROM ONE MEDIUM TO ANOTHER MEDIUM . . . . .	98
5.26 TUBES LINED WITH ABSORBING MATERIAL . . . . .	100
<b>VI. DRIVING SYSTEMS</b>	
6.1 INTRODUCTION . . . . .	101
6.2 ELECTRODYNAMIC DRIVING SYSTEM . . . . .	101
6.3 ELECTROMAGNETIC DRIVING SYSTEM . . . . .	102
A. Reed Armature Type . . . . .	103
B. Balanced Armature Type . . . . .	105
6.4 CONDENSER DRIVING SYSTEM . . . . .	107
6.5 PIEZOELECTRIC DRIVING SYSTEM . . . . .	109
<b>VII. DIRECT RADIATOR LOUD SPEAKERS</b>	
7.1 INTRODUCTION . . . . .	111
7.2 SINGLE COIL, SINGLE CONE LOUD SPEAKER . . . . .	112
7.3 MULTIPLE SINGLE CONE, SINGLE COIL LOUD SPEAKER . . . . .	119
7.4 SINGLE COIL, DOUBLE CONE LOUD SPEAKER . . . . .	120
7.5 DOUBLE COIL, SINGLE CONE LOUD SPEAKER . . . . .	121
7.6 DOUBLE COIL, DOUBLE CONE LOUD SPEAKER . . . . .	123
7.7 MECHANICAL NETWORKS FOR CONTROLLING THE HIGH FREQUENCY RESPONSE OF A LOUD SPEAKER . . . . .	124
A. Conventional Single Coil Loud Speaker . . . . .	125
B. Loud Speaker with a Compliance Shunting the Cone Impedance . . . . .	125

# CONTENTS

xi

CHAPTER	PAGE
C. Loud Speaker with a Compliance Shunting; a Compliance and Mass in Parallel, Connected in Series with Cone Impedance. . . .	125
D. Loud Speaker with a "T" Type Filter Connecting the Voice Coil Mass and the Cone Impedance. . . . .	127
7.8 LOUD SPEAKER BAFFLES. . . . .	127
7.9 CABINET REPRODUCERS. . . . .	129
7.10 BACK ENCLOSED CABINET LOUD SPEAKER. . . . .	130
7.11 ACOUSTIC PHASE INVERTER. . . . .	131
7.12 ACOUSTICAL LABYRINTH LOUD SPEAKER. . . . .	132
7.13 COMBINATION HORN AND DIRECT RADIATOR LOUD SPEAKER. . . . .	133
7.14 FEEDBACK APPLIED TO A LOUD SPEAKER. . . . .	135
7.15 NONLINEAR DISTORTION. . . . .	136
7.16 TRANSIENT RESPONSE. . . . .	138
7.17 DIAPHRAGMS (CONES) AND VOICE COILS. . . . .	142
7.18 FIELD STRUCTURES. . . . .	143
7.19 HIGH FREQUENCY SOUND DISTRIBUTOR. . . . .	143
VIII. HORN LOUD SPEAKERS	
8.1 INTRODUCTION. . . . .	145
8.2 EFFICIENCY. . . . .	145
A. The Relation Between the Voice Coil Mass, the Load Resistance and the Initial Efficiency. . . . .	146
B. The Effect of the Mass of the Vibrating System Upon the Efficiency	149
C. The Effect of the Air Chamber Upon the Efficiency. . . . .	150
D. The Effect of the Generator Impedance and the Impedance at the Throat of the Horn Upon the Efficiency. . . . .	153
E. The Effect of the Voice Coil Temperature Upon the Efficiency. . . . .	154
F. The Effect of the Radiation from the Unloaded Side of the Diaphragm Upon the Efficiency. . . . .	155
8.3 NONLINEAR DISTORTION. . . . .	156
A. Distortion Due to Air Overload in the Horn. . . . .	156
B. Distortion Due to Variation in Volume of the Air Chamber. . . . .	157
C. Distortion Due to the Diaphragm Suspension System. . . . .	160
D. Distortion Due to a Nonuniform Magnetic Field in the Air Gap. . . . .	161
E. Subharmonic Distortion. . . . .	162
F. Power Handling Capacity and the Voice Coil Temperature. . . . .	163
G. Power Handling Capacity and the Amplitude of the Diaphragm. . . . .	164
8.4 HORN LOUD SPEAKER SYSTEM	
A. Single Horn, Single Channel System. . . . .	164
B. Multiple Horn, Multiple Channel System. . . . .	167
C. Compound Horn Loud Speaker. . . . .	168
D. Multiple Horn, Single Channel System. . . . .	169
E. Folded Horns. . . . .	170
F. Diaphragms and Voice Coils. . . . .	171

CHAPTER	PAGE
G. Field Structures . . . . .	171
H. Horn Walls. Vibration and Absorption . . . . .	171
 IX. MICROPHONES	
9.1 INTRODUCTION . . . . .	172
9.2 PRESSURE MICROPHONES . . . . .	172
A. Carbon Microphones . . . . .	172
1. Single Button Carbon Microphone . . . . .	172
2. Double Button Carbon Microphone . . . . .	175
B. Condenser Microphone . . . . .	177
C. Piezoelectric (Crystal) Microphones . . . . .	180
1. Direct Actuated Crystal Microphone . . . . .	182
2. Diaphragm Actuated Crystal Microphone . . . . .	182
D. Moving Conductor Microphones . . . . .	183
1. Moving Coil Microphone (Dynamic Microphone) . . . . .	183
2. Inductor Microphone (Straight Line Conductor) . . . . .	185
3. Ribbon Type . . . . .	186
9.3 VELOCITY MICROPHONES . . . . .	189
A. Pressure Gradient Microphone . . . . .	189
B. Velocity Microphone . . . . .	194
9.4 UNIDIRECTIONAL MICROPHONES . . . . .	203
A. The Response of the Unidirectional Microphone as a Function of the Distance and the Frequency . . . . .	204
B. Efficiency of Energy Response to Random Sounds of the Unidi- rectional Microphone as a Function of the Relative Sensitivities of the Bidirectional and Nondirectional Microphones . . . . .	206
C. Efficiency of Energy Response to Random Sounds of a Unidirec- tional Microphone as a Function of the Phase Angle Between the two Units . . . . .	207
D. Distortion of the Directional Pattern in the Unidirectional Micro- phone . . . . .	210
E. Phase Shifting Unidirectional Microphones . . . . .	210
9.5 MISCELLANEOUS MICROPHONES . . . . .	212
A. Lapel Microphone . . . . .	212
B. Throat Microphone . . . . .	212
C. Hot Wire Microphone . . . . .	212
D. Batteryless Telephone (Sound Power Telephone) . . . . .	213
9.6 HIGHLY DIRECTIONAL MICROPHONES . . . . .	213
A. Parabolic Reflector . . . . .	213
B. Line Microphones . . . . .	214
1. Line Microphone: Useful Directivity on the Line Axis. Simple Line . . . . .	214
2. Line Microphone: Useful Directivity on the Line Axis. Line with Progressive Delay . . . . .	216



# CONTENTS

xiii

CHAPTER	PAGE
3. Line Microphone: Useful Directivity on the Line Axis. Two Lines and a Pressure Gradient Element . . . . .	218
4. Ultradirectional Microphone . . . . .	220
C. Directional Efficiency of a Directional Sound Collecting System . . . . .	221
9.7 WIND EXCITATION AND SCREENING OF MICROPHONES . . . . .	222
9.8 NONLINEAR DISTORTION IN MICROPHONES . . . . .	223
9.9 TRANSIENT RESPONSE OF MICROPHONES . . . . .	224
9.10 HIGH SENSITIVITY MICROPHONES (MOTIONAL IMPEDANCE) . . . . .	224
9.11 THERMAL NOISE IN MICROPHONES . . . . .	225
<b>X. MISCELLANEOUS TRANSDUCERS</b>	
10.1 INTRODUCTION . . . . .	226
10.2 TELEPHONE RECEIVERS . . . . .	226
A. Bipolar Telephone Receiver . . . . .	226
B. Crystal Telephone Receiver . . . . .	230
C. Dynamic Telephone Receiver . . . . .	230
D. Inductor Telephone Receiver . . . . .	232
10.3 PHONOGRAPHS . . . . .	233
A. Mechanical Phonograph . . . . .	233
B. Phonograph Pickups . . . . .	234
1. Crystal Pickup . . . . .	235
2. Magnetic Pickup . . . . .	236
3. Dynamic Pickup . . . . .	238
C. Distortion in Record Reproduction . . . . .	238
10.4 ELECTRICAL MUSICAL INSTRUMENTS . . . . .	240
10.5 HEARING AIDS . . . . .	241
10.6 SIRENS (COMPRESSED AIR LOUD SPEAKERS) . . . . .	242
10.7 SUPERSONICS . . . . .	243
10.8 SEISMIC DETECTORS . . . . .	243
<b>XI. MEASUREMENTS</b>	
11.1 INTRODUCTION . . . . .	245
11.2 CALIBRATION OF MICROPHONES . . . . .	245
A. Response Frequency Characteristic . . . . .	245
1. Pressure Response . . . . .	245
(a) Pistonphone . . . . .	246
(b) Thermophone . . . . .	247
(c) Electrostatic Actuator . . . . .	248
2. Field Response . . . . .	249
B. Directional Characteristic . . . . .	250
C. Nonlinear Distortion Characteristic . . . . .	251
D. Phase Distortion Characteristic . . . . .	252
E. Electrical Impedance Characteristic . . . . .	253
F. Transient Response Characteristic . . . . .	253

CHAPTER	PAGE
11.3 TESTING OF LOUD SPEAKERS . . . . .	253
A. Response Frequency Characteristic . . . . .	254
1. Response . . . . .	254
2. Apparatus for Measuring the Sound Pressure Frequency Relationship of a Sound Source . . . . .	255
3. Calibration of the Sound Measuring Equipment . . . . .	258
4. Outdoor or Free Space Response . . . . .	259
5. Living Room Measurements . . . . .	261
6. Theatre Measurements . . . . .	261
7. Automobile Measurements . . . . .	261
B. Directional Characteristic . . . . .	261
C. Nonlinear Distortion Characteristic . . . . .	262
D. Efficiency Frequency Characteristic . . . . .	265
1. Direct Determination of Radiated Power . . . . .	265
2. Indirect Determination of Radiated Power . . . . .	266
E. Phase Distortion Characteristic . . . . .	267
F. Impedance Frequency Characteristic . . . . .	268
G. Transient Response Characteristic . . . . .	268
H. Subjective Measurements . . . . .	269
11.4 TESTING OF TELEPHONE RECEIVERS . . . . .	269
A. Subjective Measurements . . . . .	269
B. Objective Measurements . . . . .	270
11.5 ARTIFICIAL VOICE . . . . .	271
11.6 MEASUREMENT OF ACOUSTIC IMPEDENCE . . . . .	271
11.7 MEASUREMENT OF NOISE . . . . .	273
11.8 MEASUREMENT OF REVERBERATION TIME . . . . .	274
11.9 MEASUREMENT OF ABSORPTION COEFFICIENT . . . . .	275
11.10 MEASUREMENT OF TRANSMISSION COEFFICIENT . . . . .	276
11.11 AUDIOMETRY . . . . .	276
11.12 ARTICULATION MEASUREMENTS . . . . .	277
<b>XII. ARCHITECTURAL ACOUSTICS AND THE COLLECTION AND DISPERSION OF SOUND</b>	
12.1 INTRODUCTION . . . . .	278
12.2 DISPERSION OF SOUND . . . . .	279
A. Sound Absorption and Reverberation . . . . .	279
B. Sound Motion Picture Reproducing Systems . . . . .	282
C. Sound Re-enforcing Systems . . . . .	286
D. Reverberation Time of a Theatre for the Reproduction of Sound . . . . .	290
E. Power Requirements for Reproducing Systems . . . . .	290
F. Noise at Different Locations . . . . .	291
G. Public Address Systems . . . . .	292
H. General Announce and Paging Systems . . . . .	296
I. Intercommunicating Systems . . . . .	297
J. Radio Receiver Operating in a Living Room . . . . .	298

# CONTENTS

XV

CHAPTER	PAGE
K. Radio Receiver Operating in an Automobile . . . . .	299
L. Absorption of Sound in Passing Through Air . . . . .	300
M. Sound Transmission Through Partitions . . . . .	301
N. Nonlinear Distortion Generated in a Plane Sound Wave . . . . .	302
12.3 COLLECTION OF SOUND . . . . .	303
A. Sound Collecting System . . . . .	303
B. Broadcasting Studios . . . . .	307
C. Reverberation Time of a Broadcasting, Recording and Scoring Studio . . . . .	308
D. Synthetic Reverberation . . . . .	309
12.4 COMPLETE REPRODUCING SYSTEMS . . . . .	309
A. Telephone . . . . .	309
B. Binaural Reproduction . . . . .	310
C. Auditory Perspective Reproduction . . . . .	311
D. Sound Motion Picture Reproducing System . . . . .	312
E. Radio Sound Reproducing System . . . . .	314
F. Phonograph Reproducing System . . . . .	315
<b>XIII. SPEECH, MUSIC AND HEARING</b>	
13.1 INTRODUCTION . . . . .	317
13.2 HEARING MECHANISM . . . . .	317
13.3 SPEECH MECHANISM . . . . .	318
A. Artificial Larynx . . . . .	318
B. Vocoder . . . . .	319
13.4 RESPONSE FREQUENCY CHARACTERISTICS OF EARS . . . . .	319
13.5 LOUDNESS OF A SOUND . . . . .	320
13.6 CHANGE OF PITCH WITH LOUDNESS . . . . .	322
13.7 MASKING . . . . .	322
13.8 NONLINEARITY OF THE EAR . . . . .	323
13.9 EFFECT OF PHASE RELATIONS AMONG THE HARMONICS . . . . .	324
13.10 MODULATION . . . . .	324
13.11 AUDITORY LOCALIZATION . . . . .	325
13.12 THE FREQUENCY AND VOLUME RANGES OF SPEECH AND MUSIC AND THE EFFECTS OF FREQUENCY DISTORTION UPON REPRODUCED SOUND . . . . .	326
13.13 ABSOLUTE AMPLITUDES AND SPECTRA OF SPEECH, MUSICAL INSTRUMENTS AND ORCHESTRAS . . . . .	328
13.14 EFFECT OF NONLINEAR DISTORTION UPON THE QUALITY OF REPRODUCED SPEECH AND MUSIC . . . . .	328
13.15 COMBINATION TONES AND NONLINEAR TRANSDUCERS . . . . .	331
13.16 MINIMUM PERCEPTIBLE DIFFERENCES . . . . .	331
13.17 TIMBRE (TONE QUALITY) . . . . .	332
13.18 NOISE IN REPRODUCING SYSTEMS . . . . .	333
13.19 MUSICAL SCALE . . . . .	334



# ELEMENTS OF ACOUSTICAL ENGINEERING

## CHAPTER I

### SOUND WAVES

**1.1. Introduction.** — A knowledge of the elements of acoustics is becoming increasingly important to any profession depending in any manner upon acoustics. Modern civilization is becoming more critical of sound reproduction. The radio receiver, phonograph, sound motion picture or sound re-enforcing system of a few years ago is not acceptable to-day. Auditoriums and studios must exhibit proper acoustic qualities. Reduction of noise in all types of machinery and appliances is demanded by the consumers. Acoustics is one of the oldest divisions of physics. A few years ago it appeared to be a decadent science. To-day acoustics is an important and necessary branch of Applied Science and its application to every phase of modern civilization is in its infancy.

The widespread interest in the phonograph, radio broadcasting, sound motion pictures, sound re-enforcing, architectural acoustics and noise problems has stimulated research and developments in these fields. During the early stages progress was made by the trial and error method. Later, by the extension and application of scientific knowledge, results have been obtained that could not have been accomplished by other means. A major portion of the problems in acoustics is concerned with vibrating systems. Comparisons between these problems and those of electricity considered from a dynamical viewpoint have led to impedance methods in acoustics. By a judicious application of dynamical theory and experimental research, the science of acoustics has developed into a wide field of interesting phenomena and with countless useful applications.

In this book, the author has attempted to outline the essentials of acoustics from the standpoint of the engineer or applied scientist. The book has been written and illustrated so that the derivations may be taken for granted. The concepts of mechanical and acoustical impedance have been introduced and applied so that anyone who is familiar with electrical circuits will be able to analyze the action of vibrating systems.

**1.2. Sound Waves.**— Sound is an alteration in pressure, particle displacement or particle velocity propagated in an elastic material or the superposition of such propagated alterations.

Sound is also the sensation produced through the ear by the alterations described above.

Sound is produced when air is set into vibration by any means whatsoever, but sound is usually produced by some vibrating object which is in contact with the air. If a string, such as used in a banjo or similar instrument, is stretched between two solid supports and plucked, sound is produced which dies down in a fairly short time. When the string is plucked it tends to spring back into its rest position, but due to its weight (mass) and speed (velocity) it goes beyond its normal position of rest. Then, in returning it again goes beyond its normal position of rest. The excursions become smaller and smaller and finally the string comes to rest. As the string moves forward it pushes air before it and compresses it, while air rushes in to fill the space left behind the moving string. In this way air is set in motion. Since air is an elastic medium, the disturbed portion transmits its motion to the surrounding air so that the disturbance is propagated in all directions from the source of disturbance.

If the string is connected in some way to a diaphragm such as a stretched drumhead of a banjo, the motion is transmitted to the drum. The drum, having a large area exposed to the air, sets a greater volume of air in motion and a much louder sound is produced.

If a light piston several inches in diameter, surrounded by a suitable baffle board several feet across, is set in rapid oscillating motion (vibration) by some external means sound is produced (Fig. 1.1). The air in front of the piston is compressed when it is driven forward, and the surrounding air expands to fill up the space left by the retreating piston when it is drawn back. Thus we have a series of compressions and rarefactions (expansions) of the air as the piston is driven back and forth. Due to the elasticity of air these areas of compression and rarefaction do not remain stationary but move outward in all directions. If a pressure gauge were set up at a fixed point and the variation in pressure noted, it would be found that the pressure varies in regular intervals and in equal amounts above and below the average atmospheric pressure. Of course, the actual variations could not be seen because of the high rate at which they occur. Now, suppose that the instantaneous pressure, along a line in the direction of sound propagation, is measured and plotted with the ordinates representing the pressure; the result would be a wavy line as shown in Fig. 1.1. The points above the straight line represent positive pressures (compressions,

condensations); the points below represent negative pressures (expansions, rarefactions) with respect to the normal atmospheric pressure represented by the straight line.

From the above examples a few of the properties of sound waves and vibrations in general may be defined.

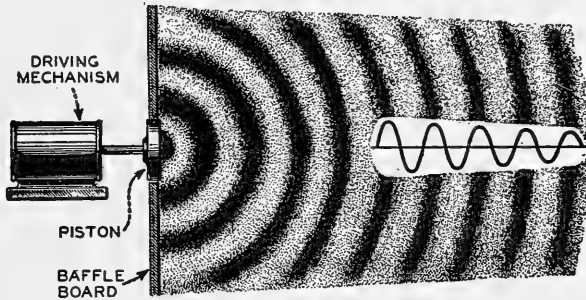

FIG. 1.1. Production of sound waves by a vibrating piston.

*Periodic Quantity.*— A periodic quantity is an oscillating quantity the values of which recur for equal increments of the independent variable.

*Cycle.*— One complete set of recurrent values of a periodic quantity comprises a cycle. Or, in other words, any one set of variations starting at one condition and returning once to the same condition is a cycle.

*Period.*— The period is the time required for one cycle of a periodic quantity.

*Frequency.*— The number of cycles occurring per unit of time, or which would occur per unit of time if all subsequent cycles were identical with the cycle under consideration is the frequency. The unit is the cycle per second.

*Fundamental Frequency.*— A fundamental frequency is the lowest component frequency of a periodic wave or quantity.

*Harmonic*— A harmonic is a component of a periodic wave or quantity having a frequency which is an integral multiple of the fundamental frequency. For example, a component, if the frequency of which is twice the fundamental frequency, is called the second harmonic.

*Subharmonic.*— A subharmonic is a component of a complex wave having a frequency which is an integral submultiple of the basic frequency.

*Wavelength.*— The wavelength of a periodic wave in an isotropic medium is the perpendicular distance between two wave fronts in which the displacements have a phase difference of one complete cycle.

*Octave.* — An octave is the interval between two frequencies having a ratio of two to one.

*Transducer.* — A transducer is a device by means of which energy may flow from one or more transmission systems to one or more other transmission systems. The energy transmitted by these systems may be of any form (for example, it may be electrical, mechanical or acoustical) and it may be the same form or different forms in the various input and output systems.

The example of Fig. 1.1 has shown graphically some of the properties of wave motion. It is the purpose of the next section to derive the fundamental wave equation. It is not necessary that the reader digest all the assumptions and processes involved in order to obtain valuable information concerning the properties of a sound wave.

**1.3. Acoustic Wave Equation.** — The general case of sound propagation involves three dimensions. The general relation for sound propagation of small amplitudes in three dimensions will be derived and then these relations will be applied to special problems.

A. *Equation of Continuity.* — The fundamental equation of hydrokinetics is the equation of continuity. This equation is merely a mathematical statement of an otherwise obvious fact that matter is neither created nor destroyed in the interior of the medium. That is, the amount of matter which enters the boundaries of a small volume equals the increase of matter inside. Consider the influx and efflux through each pair of faces of the cube of dimensions  $\Delta x$ ,  $\Delta y$  and  $\Delta z$ , the difference between the latter and the former for the whole cube is

$$-\left[ \frac{\partial(\rho'u)}{\partial x} + \frac{\partial(\rho'v)}{\partial y} + \frac{\partial(\rho'w)}{\partial z} \right] \Delta x \Delta y \Delta z \quad 1.1$$

where  $x, y, z$  = coordinates of a particle in the medium,

$u, v, w$  = component velocities of a particle in the medium, and

$\rho'$  = density of the medium.

The rate of growth of mass  $\frac{\partial \rho'}{\partial t} \Delta x \Delta y \Delta z$  in the cube must be equal to the expression 1.1 This may be written as

$$\frac{\partial \rho'}{\partial t} + \frac{\partial(\rho'u)}{\partial x} + \frac{\partial(\rho'v)}{\partial y} + \frac{\partial(\rho'w)}{\partial z} = 0 \quad 1.2$$

where  $t$  = time.

This is the equation of continuity which signifies the conservation of matter and the three dimensionality of space.



B. *Equation of Motion.* — Referring again to the space  $\Delta x \Delta y \Delta z$  the acceleration of momentum parallel to  $x$  is  $\rho' \Delta x \Delta y \Delta z \frac{\partial u}{\partial t}$ . The mean pressures on the faces perpendicular to  $x$  are

$$\left( p_0' - \frac{\partial p_0'}{\partial x} \frac{\Delta x}{2z} \right) \Delta y \Delta z \quad \text{and} \quad \left( p_0' + \frac{\partial p_0'}{\partial x} \frac{\Delta x}{2z} \right) \Delta y \Delta z$$

where  $p_0' =$  pressure in the medium.

The difference is a force  $\frac{\partial p_0}{\partial x} \Delta x \Delta y \Delta z$  in the direction of increasing  $x$ . Equating this to the acceleration of momentum, the result is the equation of motion,

$$\rho' \frac{\partial u}{\partial t} = - \frac{\partial p_0'}{\partial x}, \quad \rho' \frac{\partial v}{\partial t} = - \frac{\partial p_0'}{\partial y}, \quad \rho' \frac{\partial w}{\partial t} = - \frac{\partial p_0'}{\partial z} \tag{1.3}$$

The equation of motion may be written

$$\frac{dV_{uvw}}{dt} + \frac{1}{\rho} \text{Grad } p_0 = 0 \tag{1.4}$$

C. *Compressibility of a Gas.* — The next property of a gas which is used to derive the wave equation depends upon the thermodynamic properties of gases. The expansions and contractions in a sound wave are too rapid for the temperature of the gas to remain constant. The changes in pressure and density are so rapid that practically no heat energy has time to flow away from the compressed part of the gas before this part is no longer compressed. When the gas temperature changes, but its heat energy does not change, the compression is termed adiabatic.

In the case of an adiabatic process,

$$\frac{p_0'}{p_0} = \left( \frac{\rho'}{\rho} \right)^\gamma \tag{1.5}$$

where  $p_0 =$  static pressure. The static pressure is the pressure that would exist in the medium with no sound waves present. The unit is the dyne per square centimeter.

- $\rho =$  static or original density,
- $p_0' =$  total pressure (static + excess),
- $\rho' =$  instantaneous density (static + change), and
- $\gamma =$  ratio of specific heat at constant pressure to that at constant volume and has a value of 1.4 for air.

D. *Condensation*. — A new term will now be introduced. Condensation is defined as the ratio of the increment of density change to the original density,

$$s = \frac{\rho' - \rho}{\rho} \quad 1.6$$

Combining equations 1.5 and 1.6

$$\frac{p_0'}{p_0} = \left(\frac{\rho'}{\rho}\right)^\gamma = (1 + s)^\gamma = 1 + \gamma s \quad 1.7$$

or 
$$p_0' = p_0 + p_0 \gamma s \quad 1.8$$

The excess pressure, or instantaneous sound pressure  $p$ , is  $p_0' - p_0$ .

$$p = p_0 \gamma s \quad 1.9$$

The instantaneous sound pressure at a point is the total instantaneous pressure at that point minus the static pressure. The unit is the dyne per square centimeter. This is often called excess pressure.

The effective sound pressure at a point is the root-mean-square value of the instantaneous sound pressure over a complete cycle, at that point. The unit is the dyne per square centimeter. The term "effective sound pressure" is frequently shortened to "sound pressure."

The maximum sound pressure for any given cycle is the maximum absolute value of the instantaneous sound pressure during that cycle. The unit is the dyne per square centimeter. In the case of a sinusoidal sound wave this maximum sound pressure is also called the pressure amplitude.

The peak sound pressure for any specified time interval is the maximum absolute value of the instantaneous sound pressure in that interval. The unit is the dyne per square centimeter.

A dyne per square centimeter is the unit of sound pressure.

E. *D'Alembertian Wave Equation*. — The three equations 1.2, 1.4 and 1.5 characterize disturbances of any amplitude. The first two are non-linear save for small amplitudes. In general, acoustic waves are of infinitesimal amplitudes, the alternating pressure is small compared with the atmospheric pressure and the wavelength is so long that  $u$ ,  $v$ ,  $w$  and  $s$  change very little with  $x$ ,  $y$  and  $z$ . Substituting equation 1.6 in 1.2 and neglecting high order terms,

$$\frac{\partial s}{\partial t} + \frac{\partial u}{\partial x} + \frac{\partial v}{\partial y} + \frac{\partial w}{\partial z} = 0 \quad 1.10$$

The type of motion to be considered is irrotational, that is  $\text{Curl } V_{uvw} = 0$ . That is a necessary and sufficient condition for the existence of a scalar velocity potential  $\phi$  which is defined as

$$u = \frac{\partial \phi}{\partial x}, \quad v = \frac{\partial \phi}{\partial y}, \quad w = \frac{\partial \phi}{\partial z} \quad 1.11$$

or  $V_{uvw} = \text{Grad } \phi$

Substitute equations 1.11 in 1.3 and multiply by  $dx$ ,  $dy$  and  $dz$

$$\frac{\partial}{\partial t} d\phi = -\frac{1}{\rho} dp_0' \quad 1.12$$

or integrating

$$\frac{\partial \phi}{\partial t} = -\int \frac{dp_0'}{\rho'}$$

Since the density changes very little, the mean density,  $\rho$ , may be used. The  $\int dp_0'$  is the excess pressure, then

$$\frac{\partial \phi}{\partial t} = -\frac{p}{\rho} \quad 1.13$$

where  $p =$  excess pressure.

From equations 1.9, 1.10, 1.11 and 1.13

$$\frac{\partial^2 \phi}{\partial t^2} - \frac{\gamma p_0}{\rho} \left( \frac{\partial^2 \phi}{\partial x^2} + \frac{\partial^2 \phi}{\partial y^2} + \frac{\partial^2 \phi}{\partial z^2} \right) = 0 \quad 1.14$$

or this may be written

$$\frac{\partial^2 \phi}{\partial t^2} = c^2 \nabla^2 \phi$$

which is the standard D'Alembertian wave equation for  $\phi$ . The velocity of propagation is

$$\frac{\gamma p_0}{\rho} = c^2 \quad 1.15$$

For the velocity of sound in various mediums see Table 1.1.

**1.4. Plane Waves.** — Assume that a progressive wave proceeds along the axis of  $x$ . Then  $\phi$  is a function of  $x$  and  $t$  only and the wave equation 1.14 reduces to

$$\frac{\partial^2 \phi}{\partial t^2} = c^2 \frac{\partial^2 \phi}{\partial x^2} \quad 1.16$$

TABLE 1.1. VELOCITY OF SOUND  $c$ , IN METERS PER SECOND, DENSITY  $\rho$ , IN GRAMS PER CUBIC CENTIMETER AND THE SPECIFIC ACOUSTIC RESISTANCE  $\rho c$  IN GRAMS PER SECOND PER SQUARE CENTIMETER

<i>Substance</i>	<i>Velocity meters/sec.</i>	<i>Density gms/c.c.</i>	<i>Specific Acoustic Resistance gms/sec Cm<sup>2</sup></i>
Aluminum .....	5100	2.7	$138 \times 10^4$
Brass .....	3500	8.4	$295 \times 10^4$
Cadmium .....	2300	8.6	$198 \times 10^4$
Cobalt .....	4724	8.7	$410 \times 10^4$
Copper .....	3560	8.9	$317 \times 10^4$
Gold .....	2000	19.3	$386 \times 10^4$
Steel .....	5000	7.8	$390 \times 10^4$
Lead .....	1220	11.3	$138 \times 10^4$
Magnesium .....	4600	1.7	$79 \times 10^4$
Nickel .....	4970	8.7	$430 \times 10^4$
Platinum .....	2650	21.3	$572 \times 10^4$
Silver .....	2600	10.4	$270 \times 10^4$
Tin .....	2500	7.3	$182 \times 10^4$
Zinc .....	3700	7.0	$259 \times 10^4$
Brick .....	3650	1.8	$66 \times 10^4$
Cork .....	500	.24	$1.2 \times 10^4$
Granite .....	3950	2.7	$107 \times 10^4$
Marble .....	3810	2.7	$103 \times 10^4$
Paraffin 15° C .....	1300	.90	$11.7 \times 10^4$
Slate .....	4500	3.0	$135 \times 10^4$
Glass .....	5500	2.6	$142 \times 10^4$
Ivory .....	3010	1.8	$54 \times 10^4$
Rubber .....	54	1.0	5400
<i>Wood along the grain</i>			
Ash .....	4670	.70	$32.7 \times 10^4$
Beech .....	3340	.75	$25.0 \times 10^4$
Elm .....	4120	.57	$23.4 \times 10^4$
Fir .....	4640	.45	$20.8 \times 10^4$
Maple .....	4110	.67	$27.8 \times 10^4$
Oak .....	3850	.80	$30.7 \times 10^4$
Pine .....	3320	.50	$16.6 \times 10^4$
Poplar .....	4280	.37	$15.9 \times 10^4$
<i>Wood across the grain about one third of the above values</i>			
Paper .....	1400 to 2000	.95	$16.1 \times 10^4$
Alcohol .....	1241	.8	$9.9 \times 10^4$
Benzine .....	1166	.9	$10.5 \times 10^4$
Water 13° .....	1441	1.0	$14.4 \times 10^4$
Air 0° C .....	331	.00129	42.7
Air 20° C .....	344	.001205	41.5
Carbon Dioxide .....	258	.00197	50.8
Chlorine .....	205	.0032	65.6
Hydrogen .....	1269	.00009	11
Oxygen .....	317	.00142	45
Nitrogen .....	336	.00125	42

A solution of this equation for a simple harmonic wave traveling in the positive  $x$  direction is

$$\phi = A \cos k(ct - x) \quad 1.17$$

where

$A$  = amplitude of  $\phi$ ,

$k = 2\pi/\lambda$

$\lambda$  = wavelength.

A. *Particle Velocity in a Plane Wave.* — The particle velocity,  $u$ , employing equations 1.11 and 1.17 is

$$u = \frac{\partial \phi}{\partial x} = kA \sin k(ct - x) \quad 1.18$$

The particle velocity in a sound wave is the instantaneous velocity of a given infinitesimal part of the medium, with reference to the medium as a whole, due to the passage of the sound wave.

B. *Pressure in a Plane Wave.* — From equations 1.9, 1.13 and 1.15 the following relation may be obtained

$$\frac{\partial \phi}{\partial t} = -c^2 s \quad 1.19$$

The condensation in a plane wave from equations 1.19 and 1.17 is given by

$$s = \frac{Ak}{c} \sin kc(ct - x) \quad 1.20$$

From equations 1.9 and 1.15 the following relation may be obtained

$$p = c^2 \rho s \quad 1.21$$

Then, from equations 1.20 and 1.21 the pressure in a plane wave is

$$p = kc\rho A \sin k(ct - x) \quad 1.22$$

Note: the particle velocity, equation 1.18, and the pressure, equation 1.22 are in phase in a plane wave.

C. *Particle Amplitude in a Plane Wave.* — The particle amplitude of a sound wave is the maximum distance that the vibrating particles of the medium are displaced from the position of equilibrium.

From equation 1.18 the particle velocity is

$$\dot{\xi} = u = kA \sin k(ct - x) \quad 1.23$$

where  $\xi$  = amplitude of the particle from its equilibrium position, in centimeters.

The particle amplitude, in centimeters, is

$$\xi = -\frac{A}{c} \cos k(ct - x) \quad 1.24$$

From equations 1.20 and 1.24 the condensation is

$$s = -\frac{\partial \xi}{\partial x} \quad 1.25$$

**1.5. Spherical Waves.** — Many acoustic problems are concerned with spherical diverging waves. In spherical co-ordinates  $x = r \sin \theta \cos \psi$ ,  $y = r \sin \theta \sin \psi$  and  $z = r \cos \theta$  where  $r$  is the distance from the center,  $\theta$  is the angle between  $r$  and the  $oz$  axis and  $\psi$  is the angle between the projection of  $r$  on the  $xy$  plane and  $ox$ . Then  $\nabla^2 \theta$  becomes

$$\nabla^2 \phi = \frac{\partial^2 \phi}{\partial r^2} + \frac{2}{r} \frac{\partial \phi}{\partial r} + \frac{1}{r^2 \sin \theta} \frac{\partial}{\partial \theta} (\sin \theta) \frac{\partial \phi}{\partial \theta} + \frac{1}{r^2 \sin^2 \theta} \frac{\partial^2 \phi}{\partial \psi^2} \quad 1.26$$

For spherical symmetry about the origin

$$\nabla^2 \phi = \frac{\partial}{\partial r} (r \phi) \quad 1.27$$

The general wave equation then becomes,

$$\frac{\partial^2}{\partial t^2} (r \phi) = c^2 \frac{\partial}{\partial r} (r \phi) \quad 1.28$$

The wave equation for symmetrical spherical waves can be derived in another way. Consider the flux across the inner and outer surfaces of the spherical shell having radii of  $r - \Delta r/2$  and  $r + \Delta r/2$ , the difference is

$$-4\pi \frac{\partial}{\partial r} \left( \rho' r^2 \frac{\partial r}{\partial t} \right) \Delta r \quad 1.29$$

The velocity is

$$\frac{\partial r}{\partial t} = \frac{\partial \phi}{\partial r} \quad 1.30$$

where  $\phi$  = velocity potential.

The expression 1.29 employing equation 1.30 becomes

$$-4\pi \frac{\partial}{\partial r} \left( \rho' r^2 \frac{\partial \phi}{\partial r} \right) \Delta r \quad 1.31$$

The rate of growth of mass in the shell is

$$4\pi r^2 \frac{\partial \rho'}{\partial t} \Delta r \quad 1.32$$

The difference in flux must be equal to the rate of growth of mass, expressions 1.31 and 1.32,

$$r^2 \frac{\partial \rho'}{\partial t} + \frac{\partial}{\partial r} \left( \rho' r^2 \frac{\partial \phi}{\partial t} \right) = 0 \quad 1.33$$

Using equations 1.6, 1.9 and 1.13 equation 1.33 may be written,

$$r^2 \frac{\partial^2 \phi}{\partial t^2} - c^2 \frac{\partial}{\partial r} \left( r^2 \frac{\partial \phi}{\partial r} \right) = 0 \quad 1.34$$

Equation 1.34 may be written

$$\frac{\partial^2(r\phi)}{\partial t^2} - c^2 \frac{\partial^2(r\phi)}{\partial r^2} = 0 \quad 1.35$$

which is the same as equation 1.28. The solution of equation 1.35 for diverging waves is

$$\phi = \frac{A}{r} e^{jk(ct-r)} \quad 1.36$$

From equations 1.19 and 1.36 the condensation is given by

$$s = -\frac{1}{c^2} \frac{\partial \phi}{\partial t} = -\frac{jkA}{cr} e^{jk(ct-r)} \quad 1.37$$

A. *Pressure in a Spherical Wave.* — The pressure from equation 1.21 is

$$p = c^2 \rho s \quad 1.38$$

The pressure then from equations 1.37 and 1.38 is

$$p = -\frac{jk c A \rho}{r} e^{jk(ct-r)} \quad 1.39$$

Retaining the real part of equation 1.39 the pressure is

$$p = \rho \frac{kcA}{r} \sin k(ct - r) \quad 1.40$$

B. *Particle Velocity in a Spherical Wave.* — The particle velocity from equations 1.11 and 1.36 is

$$u = - \left( \frac{1}{r} + jk \right) \frac{A}{r} e^{jk(ct-r)} \quad 1.41$$

Retaining the real part of equation 1.41 the particle velocity is

$$u = - \frac{Ak}{r} \left[ \frac{1}{kr} \cos k(ct - r) - \sin k(ct - r) \right] \quad 1.42$$

C. *Phase Angle between the Pressure and the Particle Velocity in a Spherical Wave.* — The particle velocity given by equation 1.42 may be written

$$u = \frac{A}{r} \sqrt{\frac{1}{kr^2} + k^2} \sin [k(ct - r) - \theta] \quad 1.43$$

where  $\tan \theta = 1/kr$ .

Comparing equation 1.43 with equation 1.40 for the pressure it will be seen that the phase angle between the pressure and velocity in a spherical wave is given by

$$\theta = \tan^{-1} \frac{1}{kr} \quad 1.44$$

For very large values of  $kr$ , that is, plane waves, the pressure and particle velocity are in phase. The phase angle frequency characteristics for various distances from the center of a spherical wave system are shown in Fig. 1.2.

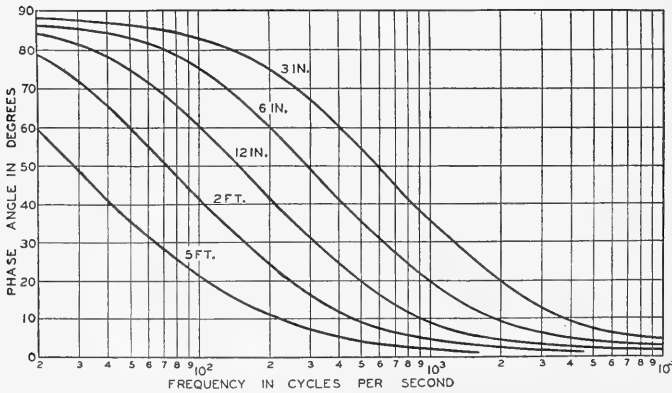

FIG. 1.2. Phase angle between the pressure and particle velocity in a spherical sound wave for distances of  $\frac{1}{3}$ ,  $\frac{2}{3}$ , 1, 2 and 5 feet from the source. (Courtesy of The Blakiston Company from Olson and Massa, Applied Acoustics.)



D. *Ratio of the Absolute Magnitudes of the Particle Velocity and the Pressure in a Spherical Sound Wave.* — From equations 1.40 and 1.43 the ratio of the absolute value of the particle velocity to the absolute value of the pressure is given by

$$\text{Ratio} = \frac{\sqrt{1 + k^2 r^2}}{\rho c k r} \quad 1.45$$

The ratio in equation 1.45, for various distances from the center in a spherical wave system, as a function of the frequency is plotted in Fig. 1.3.

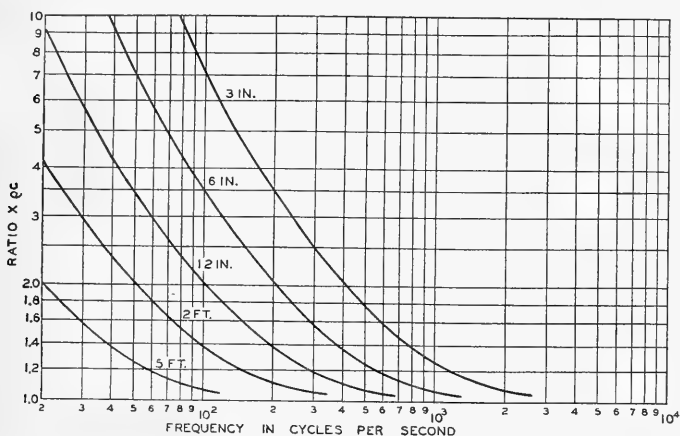

FIG. 1.3. Ratio of the absolute magnitude of the particle velocity to the pressure in a spherical sound wave for distances of  $\frac{1}{4}$ ,  $\frac{1}{2}$ , 1, 2 and 5 feet from the source. (Courtesy of The Blakiston Company from Olson and Massa, Applied Acoustics.)

**1.6. Stationary Waves.** — Stationary waves are the wave system resulting from the interference of waves of the same frequencies and are characterized by the existence of nodes or partial nodes.

Consider two plane waves of equal amplitude traveling in opposite directions; the velocity potential may be expressed as

$$\phi = [\cos k(ct - x) + \cos k(ct + x)] \quad 1.46$$

The pressure in this wave system from equations 1.19 and 1.21 is

$$p = -\rho \frac{\partial \phi}{\partial t} = kc\rho A [\sin k(ct - x) + \sin k(ct + x)] \quad 1.47$$

$$p = 2kc\rho A [\sin kct \cos kx] \quad 1.48$$

The particle velocity in this wave system from equations 1.11 and 1.46 is

$$u = \frac{\partial \phi}{\partial x} = kA [\sin k(ct - x) - \sin k(ct + x)] \quad 1.49$$

$$u = -2kA [\cos kct \sin kx] \quad 1.50$$

$$u = 2kA \left[ \sin \left( kct - \frac{\pi}{2} \right) \cos \left( kx - \frac{\pi}{2} \right) \right] \quad 1.51$$

Equations 1.48 and 1.51 show that the maxima of the particle velocity and pressure are separated by a quarter wavelength. The maxima of  $p$  and  $u$  differ by  $90^\circ$  in time phase.

A stationary wave system is produced by the reflection of a plane wave by an infinite wall normal to the direction of propagation. This is the simplest type of standing wave system. Complex stationary wave systems are produced when a sound source operates in a room due to the reflections from the walls, ceiling and floor.

**1.7. Sound Energy Density.** — Sound energy density is the sound energy per unit volume. The unit is the erg per cubic centimeter.

The sound energy density in a plane wave is

$$E = \frac{p^2}{\rho c^2} \quad 1.52$$

where  $p$  = sound pressure, in dynes per square centimeter,

$\rho$  = density, in grams per cubic centimeter, and

$c$  = velocity of sound in centimeters per second.

The positive radiation pressure in dynes per square centimeter exerted by sound waves upon an infinite wall is

$$p = (\gamma + 1)E \quad 1.53$$

where  $E$  = energy density of the incident wave train in ergs per cubic centimeter, and

$\gamma$  = ratio of specific heats, 1.4 for air.

Instruments for measuring the radiation pressure have been built, consisting of a light piston mounted in a large wall with means for measuring the force on the piston. Since the radiation pressure is very small these instruments must be quite delicate.

**1.8. Sound Intensity.** — The sound intensity of a sound field in a specified direction at a point is the sound energy transmitted per unit of time

in the specified direction through a unit area normal to this direction at the point. The unit is the erg per second per square centimeter. It may also be expressed in watts per square centimeter.

The intensity, in ergs per second per square centimeter, of a plane wave is

$$I = \frac{p^2}{\rho c} = pu = \rho cu^2 \quad 1.54$$

where  $p$  = pressure, in dynes per square centimeter,

$u$  = particle velocity, in centimeters per second,

$c$  = velocity of propagation, in centimeters per second, and

$\rho$  = density of the medium, in grams per cubic centimeter.

The product  $\rho c$  is termed the specific acoustic resistance of the medium. The specific acoustic resistance of various mediums is shown in Table 1.1.

**1.9. Decibels (Bels).**— In acoustics the ranges of intensities, pressures, etc., are so large that it is convenient to use a scale of smaller numbers termed decibels. The abbreviation db is used for the term decibel. The bel is the fundamental division of a logarithmic scale for expressing the ratio of two amounts of power, the number of bels denoting such a ratio being the logarithm to the base ten of this ratio. The decibel is one tenth of a bel. For example, with  $P_1$  and  $P_2$  designating two amounts of power and  $n$  the number of decibels denoting their ratio:

$$n = 10 \log_{10} \frac{P_1}{P_2}, \text{ decibels.} \quad 1.55$$

When the conditions are such that ratios of currents or ratios of voltages (or the analogous quantities such as pressures, volume currents, forces and particle velocities) are the square roots of the corresponding power ratios, the number of decibels by which the corresponding powers differ is expressed by the following formulas:

$$n = 20 \log_{10} \frac{i_1}{i_2}, \text{ decibels} \quad 1.56$$

$$n = 20 \log_{10} \frac{e_1}{e_2}, \text{ decibels} \quad 1.57$$

where  $i_1/i_2$  and  $e_1/e_2$  are the given current and voltage ratios respectively.

For relation between decibels and power and current or voltage ratios see Table 1.2.

TABLE 1.2. THE RELATION BETWEEN DECIBELS AND POWER AND CURRENT OR VOLTAGE RATIOS

POWER RATIO	DECIBELS
1	0
2	3.0
3	4.8
4	6.0
5	7.0
6	7.8
7	8.5
8	9.0
9	9.5
10	10
100	20
1000	30
10000	40
100000	50
1000000	60

CURRENT OR VOLTAGE RATIO	DECIBELS
1	0.
2	6.0
3	9.5
4	12.0
5	14.0
6	15.6
7	16.9
8	18.1
9	19.1
10	20
100	40
1000	60
10000	80
100000	100
1000000	120

**1.10. Doppler Effect.** — The change in pitch of a sound due to the relative motion of the source and observer is termed the Doppler Effect. When the source and observer are approaching each other the pitch observed by the listener is higher than the actual frequency of the sound source. If the source and observer are receding from each other the pitch is lower.

The frequency at the observation point is

$$f_0 = \frac{v - v_0}{v - v_s} f_s \quad 1.58$$

where  $v$  = velocity of sound in the medium,

$v_0$  = velocity of the observer,

$v_s$  = velocity of the source, and

$f_s$  = frequency of the source.

All the velocities must be in the same units.

No account is taken of the effect of wind velocity or motion of the medium in equation 1.58. In order to bring in the effect of the wind, the velocity  $v$  in the medium must be replaced by  $v + w$  where  $w$  is the wind

velocity in the direction in which the sound is traveling. Making this substitution in 1.58 the result is

$$f_0 = \frac{v + w - v_0}{v + w - v_s} f_s \quad 1.59$$

Equation 1.59 shows that the wind does not produce any change in pitch unless there is some relative motion of the sound source and the observer.

**1.11. Refraction and Diffraction.** — The change in direction of propagation of sound, produced by a change in the nature of the medium which affects the velocity, is termed refraction. Sound is refracted when the

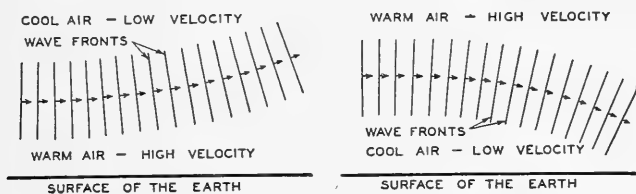

FIG. 1.4. The refraction of a sound wave in air.

density varies over the wave front. (See equation 1.15.) A sound wave may be bent either downward or upward depending upon the relative temperatures (densities) of the air,<sup>1</sup> Fig. 1.4. The distance over which sound may be heard is greater when the wave is bent downward than when it is bent upward. The first condition usually obtains during the early morning hours while the latter condition prevails during the day.

Diffraction is the change in direction of propagation of sound due to the passage of sound around an obstacle. It is well known that sound will travel around an obstacle. The larger the ratio of the wavelength to the dimensions of the obstacle the greater the diffraction. The diffraction around the head is important in both speaking and listening. The diffraction of sound by microphones and loud speakers is important in the performance of these instruments. The diffraction<sup>2</sup> of sound by a sphere, a cube and a cylinder as a function of the dimensions is shown in Fig. 1.5. These data may be used to predict the diffraction of sound by objects of these general shapes. As, for example, the sphere may be used to predict the diffraction of sound by the human head.

<sup>1</sup> For other phenomena of atmospheric acoustics such as the effects of wind and temperature upon the propagation of sound waves and the applications to sound ranging and signaling in air, see Stewart and Lindsay, "Acoustics," D. Van Nostrand Co., New York City.

<sup>2</sup> Muller, Black and Dunn, *Jour. Acous. Soc. Amer.*, Vol. 10, No. 1, p. 6, 1938.

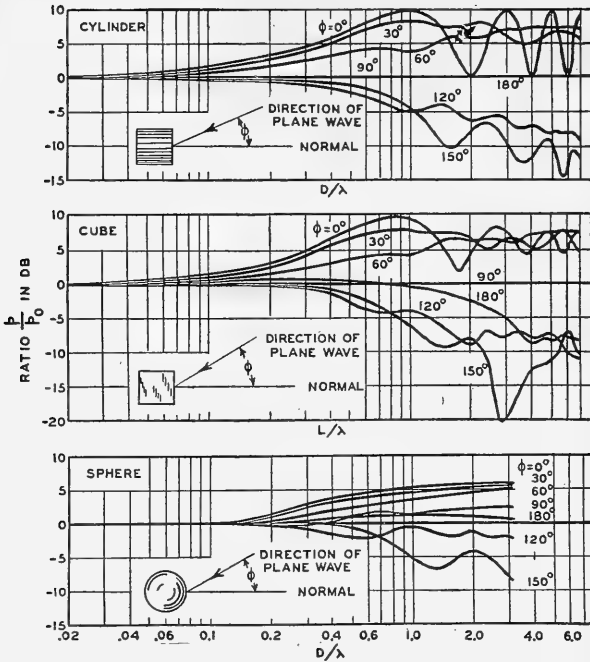

FIG. 1.5. The diffraction of a sound wave by a cylinder, cube and sphere. (After Muller, Black and Dunn.)

Another example of diffraction of sound is illustrated by the zone plate shown in Fig. 1.6. The path lengths of the sound from the source to the focus varies by an integral wavelength. As a consequence, all the pencils

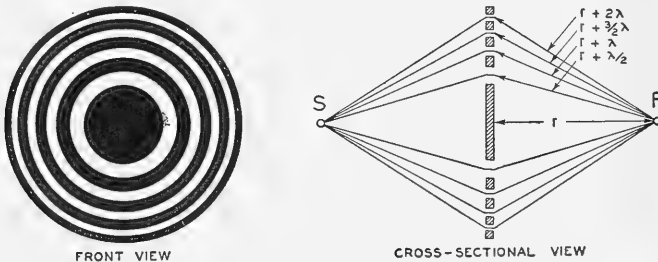

FIG. 1.6. Zone plate. The source  $S$  and the focus  $F$  are equidistant from the zone plate.

of sound are in phase at the focus with the result that the sound pressure is considerably greater at this point than any other position behind the zone plate.

## CHAPTER II

### ACOUSTICAL RADIATING SYSTEMS

**2.1. Introduction.**—There are almost an infinite number of different types of sound sources. The most common of these are the human voice, musical instruments, machinery noises and loud speakers. The most important factors which characterize a sound source are the directional pattern, the radiation efficiency and the output as a function of the frequency. In the case of some sound sources as, for example, musical instruments, it is almost impossible to analyze the action. However, in the case of most sound reproducers the action may be predicted with amazing accuracy. It is the purpose of this chapter to consider some of the simple sound sources that are applicable to the problems of sound reproduction.

**2.2. Simple Point Source.**—A point source is a small source which alternately injects fluid into a medium and withdraws it.

*A. Point Source Radiating into an Infinite Medium. Solid Angle of  $4\pi$  Steradians.*—Consider a point source having a maximum rate of fluid emission of  $4\pi A$  cubic centimeters per second. The momentary rate at a time  $t$  is  $4\pi A \cos \omega t$ . The maximum rate of fluid emission may be written

$$-4\pi A = S \dot{\xi}_0 \quad 2.1$$

where  $S$  = area of the surface of the source, in square centimeters, and  $\dot{\xi}_0$  = maximum velocity, in centimeters per second over the surface  $S$ .

The velocity potential of a point source from equation 1.36 is

$$\phi_r = \frac{A}{r} e^{jk(ct-r)} \quad 2.2$$

The particle velocity at a distance  $r$  from equation 1.42 is

$$u = -\frac{Ak}{r} \left[ \frac{1}{kr} \cos k(ct-r) - \sin k(ct-r) \right] \quad 2.3$$

The pressure at a distance  $r$  from equation 1.40 is

$$p = \frac{\rho kcA}{r} \sin k(ct-r) \quad 2.4$$

The intensity or average power, in ergs per second, transmitted through a unit area at a distance  $r$ , in centimeters, is the product of  $p$  and  $u$  and is given by

$$P = \frac{\rho c k^2 A^2}{2r^2} \quad 2.5$$

The total average power in ergs per second emitted by the source is

$$P_T = 2\pi\rho c k^2 A^2 \quad 2.6$$

where  $\rho$  = density of the medium, in grams per cubic centimeter,

$c$  = velocity of sound, in centimeters per second,

$k = 2\pi/\lambda$ ,

$\lambda$  = wavelength, in centimeters, and

$A$  is defined by equation 2.1.

*B. Point Source Radiating into a Semi-Infinite Medium. Solid Angle of  $2\pi$  Steradians.* — The above example considered a point source operating in an infinite medium. The next problem of interest is that of a point source operating in a semi-infinite medium, for example, a point source near an infinite wall.

In this case we can employ the principle of images as shown in Fig. 2.1. The pressure, assuming the same distance from the source, is two times that of the infinite medium. The particle velocity is also two times that of the infinite medium. The average power transmitted through a unit area is four times that of the infinite medium. The average power output of the source, however, is two times that of a simple source operating in an infinite medium.

*C. Point Source Radiating into a Solid Angle of  $\pi$  Steradians.* — Employing the method of images Fig. 2.1 the pressure is four times, the particle velocity is four times and the average power transmitted through a unit area is sixteen times that of an infinite medium for the same distance. The average power output of the source is four times that of a simple source operating in an infinite medium.

*D. Point Source Radiating into a Solid Angle of  $\pi/2$  Steradians.* — Employing the method of images, Fig. 2.1, the pressure is eight times, the particle velocity eight times and the average power transmitted through a unit area is sixty-four times that of the same source operating in an infinite medium at the same distance. The average power output is eight times that of the same simple source operating in an infinite medium.

*E. Application of the Simple Source.* — The above data may be applied to acoustic radiators in which the dimensions are small compared to the



wavelength and located close to the boundaries indicated above. For example, *A* would correspond to a loud speaker, which acts as a simple source, suspended in space at a large distance from any walls or boundaries. *B* would correspond to a loud speaker placed on the floor in the center of the room. *C* would correspond to a loud speaker placed on the floor along



	SOLID ANGLE OF SOUND EMISSION	PRESSURE AT A DISTANCE <i>r</i>	POWER OUTPUT	ENERGY DENSITY AT DISTANCE <i>r</i>
	$4\pi$	$p$	$w$	$i$
	$2\pi$	$2p$	$2w$	$4i$
	$\pi$	$4p$	$4w$	$16i$
	$\frac{\pi}{2}$	$8p$	$8w$	$64i$

FIG. 2.1. The pressure, total power output and energy density delivered by a point source operating in solid angles of  $4\pi$ ,  $2\pi$ ,  $\pi$  and  $\pi/2$  steradians.

a wall, and *D* would correspond to a loud speaker placed in the corner of the room. Of course, as pointed out above, these examples hold only when the dimensions of the radiator and the distance from the wall are small compared to the wavelength.

**2.3. Double Source (Doublet Source)<sup>1,2,3,4</sup>** — A double source consists of two point sources equal in strength  $\pm 4\pi A'$ , but opposite in phase sepa-

<sup>1</sup> Lamb, "Dynamical Theory of Sound," p. 230, E. Arnold, London.  
<sup>2</sup> Davis, "Modern Acoustics," p. 59, Macmillan Co., New York.  
<sup>3</sup> Wood, "A Textbook of Sound," p. 64, Bell and Sons, London.  
<sup>4</sup> Crandall, "Theory of Vibrating Systems and Sound," p. 135, D. Van Nostrand Co., New York.

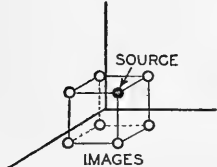
rated by a vanishingly small distance  $\delta r$ . The strength of the doublet is  $4\pi A'\delta r$ . Let  $A'\delta r = A$ . In these considerations  $A'$  corresponds to  $A$  of equation 2.1, that is  $4\pi A' = S\dot{\xi}_0$ .

At a distance  $r$  in a direction inclined at an angle  $\alpha$  to the axis of the doublet the velocity potential is

$$\phi = \frac{\left(\frac{1}{r} + jk\right)A}{r} \epsilon^{jk(ct-r)} \cos \alpha \quad 2.7$$

The pressure from equation 2.7 is

$$p = -\rho \frac{\partial \phi}{\partial t} = -j \frac{\rho ck A}{r} \left(\frac{1}{r} + jk\right) \epsilon^{jk(ct-r)} \cos \alpha \quad 2.8$$

Retaining the real parts of equation 2.8

$$p = \frac{\rho ck A}{r} \left[ \frac{1}{r} \sin k(ct-r) + k \cos k(ct-r) \right] \cos \alpha \quad 2.9$$

At a very large distance

$$p \propto \frac{k^2 A}{r} \cos \alpha \quad 2.10$$

At a very small distance

$$p \propto \frac{kA}{r^2} \cos \alpha \quad 2.11$$

The particle velocity has two components, the radial  $\frac{\partial \phi}{\partial r}$  and the transverse  $\frac{1}{r} \frac{\partial \phi}{\partial \alpha}$ . The radial component of the particle velocity from equation 2.7 is,

$$u = \frac{\partial \phi}{\partial r} = - \left[ \left( \frac{2}{r^3} + \frac{jk}{r^2} + jk \left( \frac{1}{r^2} + \frac{jk}{r} \right) \right) A \epsilon^{jk(ct-r)} \cos \alpha \right] \quad 2.12$$

Retaining the real parts of equation 2.12

$$u = -A \left[ \left( \frac{2}{r^3} - \frac{k^2}{r} \right) \cos k(ct-r) - \frac{2k}{r^2} \sin k(ct-r) \right] \cos \alpha \quad 2.13$$

At a very large distance

$$u \propto \frac{Ak^2}{r} \cos \alpha \quad 2.14$$

At a very small distance

$$u \propto \frac{A}{r^3} \cos \alpha \tag{2.15}$$

The transverse component of the particle velocity is

$$u = \frac{1}{r} \frac{\partial \phi}{\partial \alpha} = - \left( \frac{1}{r} + jk \right) \frac{A}{r^2} e^{jk(ct-r)} \sin \alpha \tag{2.16}$$

Retaining the real parts of equation 2.16

$$u = - A \left[ \frac{1}{r^3} \cos k(ct - r) - \frac{k}{r^2} \sin k(ct - r) \right] \sin \alpha \tag{2.17}$$

At a very large distance

$$u \propto \frac{Ak}{r^2} \sin \alpha \tag{2.18}$$

At a very small distance

$$u \propto \frac{A}{r^3} \sin \alpha \tag{2.19}$$

Figure 2.2 shows the velocity components and the pressure for various points around a doublet source. A common example of a doublet source is a direct radiator loud speaker mounted in a small baffle. (Dimensions of the baffle small compared to the wavelength.) If the response of such a loud speaker is measured with a pressure microphone for various angles at a constant distance the result will be a cosine characteristic. If the response is measured with a velocity microphone keeping the axis pointed towards the loud speaker the result will be a cosine directional characteristic. If the same is repeated keeping the axis of the velocity microphone normal to the line joining the microphone and the loud speaker the result will be a sine directional characteristic.

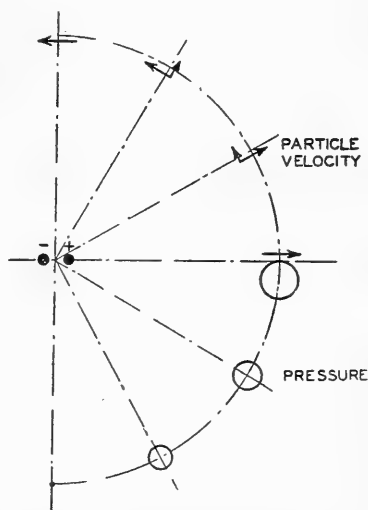

FIG. 2.2. The pressure and particle velocity at a constant distance from a doublet source. The magnitude of the pressure is indicated by the diameter of the circle. The particle velocity has two components: a radial and transverse component. The direction and magnitude of these two components are indicated by vectors.

The total power, in ergs, emitted by a doublet source is

$$P = \iint \frac{p^2}{\rho c} dS \quad 2.20$$

where  $p$  = pressure, in dynes per square centimeter,  
 $\rho$  = density, in grams per cubic centimeter,  
 $c$  = velocity of sound, in centimeters per second, and  
 $dS$  = area, in square centimeters, over which the pressure is  $p$ .

Taking the value of  $p$  from equation 2.9 (for  $r$  very large) the total average power in ergs per second emitted by a doublet source is

$$P_T = 2\pi r^2 \int_0^\pi \frac{\rho c k^4 A^2}{2r^2} \cos^2 \alpha \sin \alpha d\alpha \quad 2.21$$

$$P_T = \frac{2}{3}\pi \rho c k^4 A^2 \quad 2.22$$

where  $\rho$  = density, in grams per cubic centimeter,  
 $k = 2\pi/\lambda$ ,  
 $\lambda$  = wavelength, in centimeters,  
 $c$  = velocity of sound, in centimeters per second, and  
 $A$  is defined in the first paragraph of this section.

The power output from a simple source (equation 2.6) is proportional to the square of the frequency, while the power output from a doublet source (equation 2.22) is proportional to the fourth power of the frequency. For this reason the power output of a direct radiator loud speaker falls off rapidly with frequency when the dimensions of the baffle are small compared to the wavelength. See Sec. 7.7.

**2.4. Straight Line Source.** — A straight line source may be made up of a large number of points of equal intensity on a line separated by equal and very small distances. The directional characteristic<sup>5,6,7</sup> of such a line is

$$R_\alpha = \frac{\sin\left(\frac{n\pi d}{\lambda} \sin \alpha\right)}{n \sin\left(\frac{\pi d}{\lambda} \sin \alpha\right)} \quad 2.23$$

where  $R_\alpha$  = ratio of the pressure for an angle  $\alpha$  to the pressure for an angle  $\alpha = 0$ . The direction  $\alpha = 0$  is normal to the line,

<sup>5</sup> Wolff, I., and Malter, L., *Acous. Soc. Amer.*, Vol. 2, No. 2, p. 201, 1930.

<sup>6</sup> Stenzel, H., *Elek. Nach. Tech.*, Vol. 4, No. 6, p. 239, 1927.

<sup>7</sup> Stenzel, H., *Elek. Nach. Tech.*, Vol. 6, No. 5, p. 165, 1929.

- $n$  = number of sources,
- $d$  = distances between the sources, in centimeters, and
- $\lambda$  = wavelength, in centimeters.

If the number of sources  $n$  approach infinity and  $d$ , the distance between the sources, approach zero in such a way that

$$nd = l$$

the limiting case is the line source. If this is carried out equation 2.23 becomes

$$R_\alpha = \frac{\sin \frac{\pi l}{\lambda} \sin \alpha}{\frac{\pi l}{\lambda} \sin \alpha} \tag{2.24}$$

The directional characteristics of a continuous line source are shown in Fig. 2.3. The directional characteristics are symmetrical about the line as an axis. Referring to Fig. 2.3, it will be seen that there is practically

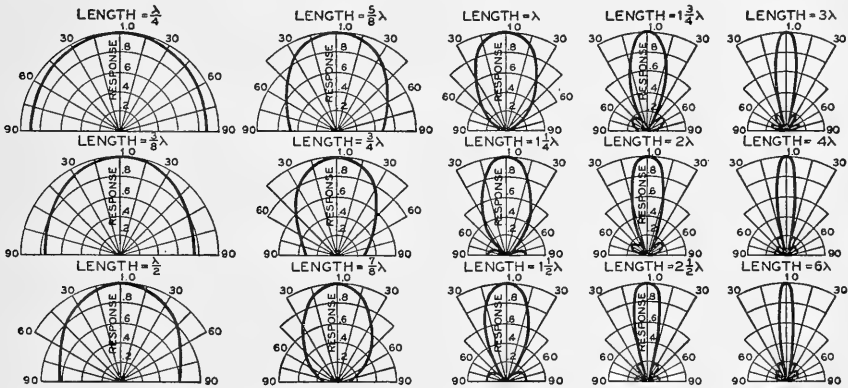

FIG. 2.3. Directional characteristics of a line source as a function of the length and the wavelength. The polar graph depicts the pressure, at a large fixed distance, as a function of the angle. The pressure for the angle  $0^\circ$  is arbitrarily chosen as unity. The direction corresponding to the angle  $0^\circ$  is perpendicular to the line. The directional characteristics in three dimensions are surfaces of revolution about the line as an axis.

no directivity when the length of the line is small compared to the wavelength. On the other hand, the directional characteristics are sharp when the length of the line is several wavelengths.

**2.5. Curved Line Source (Arc of a Circle).** — A curved line source may be made up of a large number of points on the arc of a circle separated by very small distances. The directional characteristics of such a line in the

plane of the arc is,

$$R_\alpha = \frac{1}{2m+1} \left| \sum_{k=-m}^{k=m} \cos \left[ \frac{2\pi R}{\lambda} \cos(\alpha + k\theta) \right] + j \sum_{k=-m}^{k=m} \sin \left[ \frac{2\pi R}{\lambda} \cos(\alpha + k\theta) \right] \right| \quad 2.25$$

where  $R_\alpha$  = ratio of the pressure for an angle  $\alpha$  to the pressure for an angle  $\alpha = 0$ ,

$\alpha$  = angle between the radius drawn through the central point and the line joining the source and the distant observation point,

$\lambda$  = wavelength, in centimeters,

$R$  = radius of the arc, in centimeters,

$2m + 1$  = number of points,

$\theta$  = angle subtended by any two points at the center of the arc, and

$k$  = variable.

Another method<sup>8</sup> is to break up the arc into a large number of equal chords. The intensity is assumed to be uniform over each chord. Also the phase of all of the chords is the same. In this case the result takes the form,

$$R_\alpha = \frac{1}{2m+1} \left| \sum_{k=-m}^{k=m} \cos \left\{ \frac{2\pi R}{\lambda} \cos(\alpha + k\theta) \right\} \frac{\sin \left[ \frac{\pi d}{\lambda} \sin(\alpha + k\theta) \right]}{\frac{\pi d}{\lambda} \sin(\alpha + k\theta)} + j \sum_{k=-m}^{k=m} \sin \left\{ \frac{2\pi R}{\lambda} \cos(\alpha + k\theta) \right\} \frac{\sin \left[ \frac{\pi d}{\lambda} \sin(\alpha + k\theta) \right]}{\frac{\pi d}{\lambda} \sin(\alpha + k\theta)} \right| \quad 2.26$$

where  $R_\alpha$  = ratio of the pressure for an angle  $\alpha$  to the pressure for an angle  $\alpha = 0$ ,

$\lambda$  = wavelength, in centimeters,

$k$  = variable,

$R$  = radius of the arc, in centimeters,

$2m + 1$  = number of chords,

$\theta$  = angle subtended by any of the chords at the center of circumscribing circle, and

$d$  = length of one of the chords, in centimeters.

<sup>8</sup> Wolff, I. and Malter, L., *Four. Acous. Soc. Amer.*, Vol. 2, No. 2, p. 201, 1930.

The directional characteristics for an arc of  $60^\circ$ ,  $90^\circ$  and  $120^\circ$  are shown in Figs. 2.4, 2.5 and 2.6. The interesting feature of the directional char-

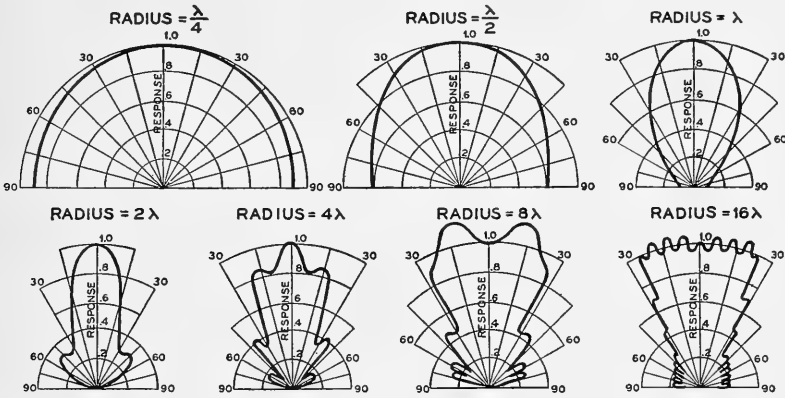

FIG. 2.4. Directional characteristics of a  $60^\circ$  arc as a function of the radius and the wavelength. The polar graph depicts the pressure, at a large fixed distance, as a function of the angle in the plane of the arc. The pressure for the angle  $0^\circ$  is arbitrarily chosen as unity.

acteristics of an arc is that the directional characteristics are very broad for wavelengths large compared to the dimensions, and are narrow for

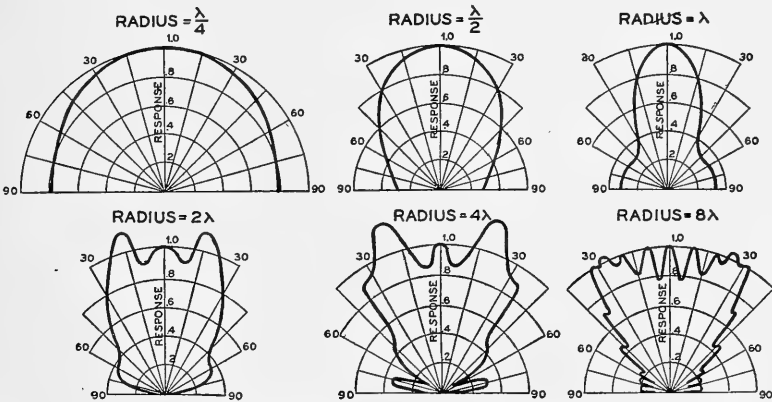

FIG. 2.5. Directional characteristics of a  $90^\circ$  arc as a function of the radius and the wavelength. The polar graph depicts the pressure at a large fixed distance, as a function of the angle in the plane of the arc. The pressure for the angle  $0^\circ$  is arbitrarily chosen as unity.

wavelengths comparable to the dimensions and are broad again for wavelengths small compared to the dimensions of the arc. The arc must be

several wavelengths in length in order to yield a “wedge-shaped” directional characteristic.

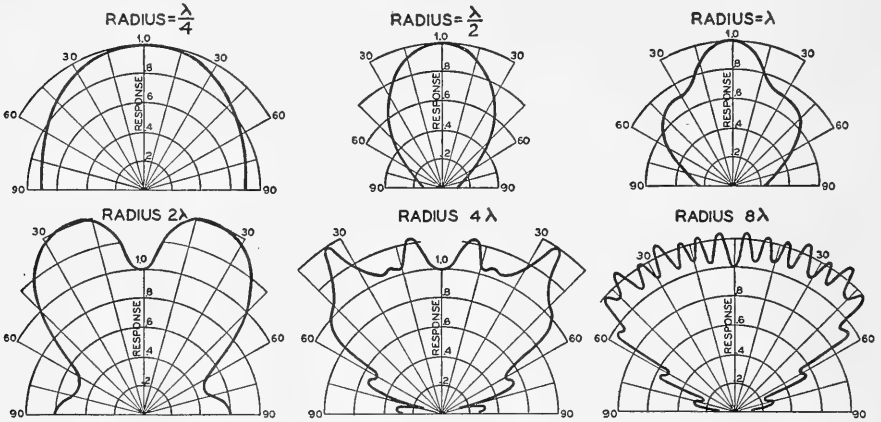

FIG. 2.6. Directional characteristics of a  $120^\circ$  arc as a function of the radius and the wavelength. The polar graph depicts the pressure, at a large fixed distance, as a function of the angle in the plane of the arc. The pressure for the angle  $0^\circ$  is arbitrarily chosen as unity.

**2.6. Circular Ring Source.** — The directional characteristics<sup>9,10</sup> of a circular ring source of uniform intensity at all points on the ring is

$$R_\alpha = J_0 \left\{ \left( \frac{2\pi R}{\lambda} \right) \sin \alpha \right\} \quad 2.27$$

where  $R_\alpha$  = ratio of the pressure for an angle  $\alpha$  to the pressure for an angle  $\alpha = 0$ ,

$J_0$  = Bessel Function of zero order,

$R$  = radius of the circle, in centimeters, and

$\alpha$  = angle between the axis of the circle and the line joining the point of observation and the center of the circle.

The directional characteristics of a circular ring source as a function of the diameter and the wavelength are shown in Fig. 2.7. The shapes are quite similar to those of a straight line. The characteristic is somewhat sharper than that of a uniform line of length equal to the diameter of the circle, but has almost the same form.

<sup>9</sup> Stenzel, H., *Elek. Nach. Tech.*, Vol. 4, No. 6, p. 1, 1927.

<sup>10</sup> Wolff, I. and Malter, L., *Jour. Acous. Soc. Amer.*, Vol. 2, No. 2, p. 201, 1930.



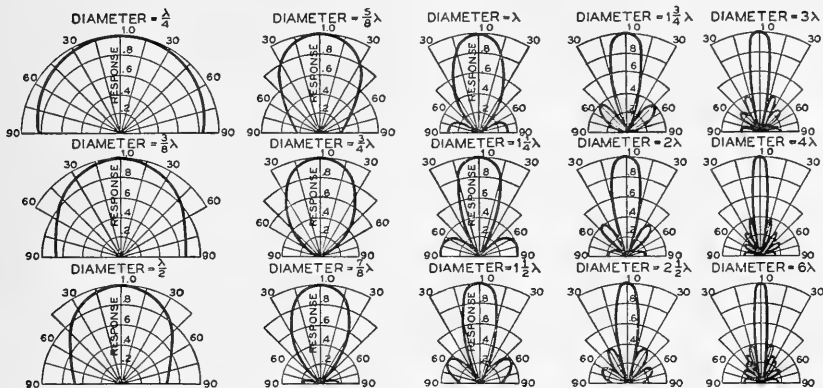

FIG. 2.7. Directional characteristics of a circular line or ring source as a function of the diameter and wavelength. The polar graph depicts the pressure, at a large fixed distance, as a function of the angle. The pressure for the angle  $0^\circ$  is arbitrarily chosen as unity. The direction corresponding to the angle  $0^\circ$  is the axis. The axis is the center line perpendicular to the plane of the circle. The directional characteristics in three dimensions are surfaces of revolution about the axis.

**2.7. Plane Circular Surface Source.**— The directional characteristics <sup>11,12</sup> of a circular surface source with all parts of the surface vibrating with the same intensity and phase is

$$R_\alpha = \frac{2J_1\left(\frac{2\pi R}{\lambda} \sin \alpha\right)}{\frac{2\pi R}{\lambda} \sin \alpha} \tag{2.28}$$

where  $R_\alpha$  = ratio of the pressure for an angle  $\alpha$  to the pressure for an angle  $\alpha = 0$ ,

$J_1$  = Bessel Function of the first order,

$R$  = radius of the circle, in centimeters,

$\alpha$  = angle between the axis of the circle and the line joining the point of observation and the center of the circle, and

$\lambda$  = wavelength, in centimeters.

The directional characteristics of a plane circular surface source as a function of the diameter and wavelength are shown in Fig. 2.8. The characteristic is somewhat broader than that of the uniform line of length equal to the diameter of the circle, but has approximately the same form.

Equation 2.28 for the directional characteristics of a circular surface

<sup>11</sup> Stenzel, H., *Elek. Nach. Tech.*, Vol. 4, No. 6, p. 1, 1927.

<sup>12</sup> Wolff, I. and Malter, L., *Jour. Acous. Soc. Amer.*, Vol. 2, No. 2, p. 201, 1930.

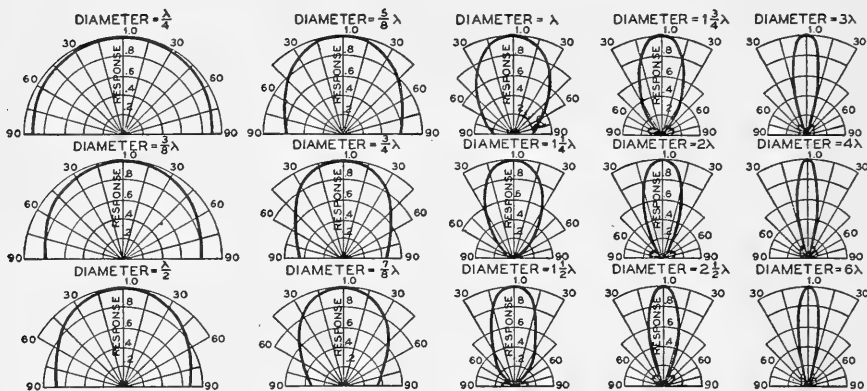

FIG. 2.8. Directional characteristics of a circular piston source as a function of the diameter and wavelength. The polar graph depicts the pressure, at a large fixed distance, as a function of the angle. The pressure for the angle  $0^\circ$  is arbitrarily chosen as unity. The direction corresponding to the angle  $0^\circ$  is the axis. The axis is the center line perpendicular to the plane of the piston. The directional characteristics in three dimensions are surfaces of revolution about the axis.

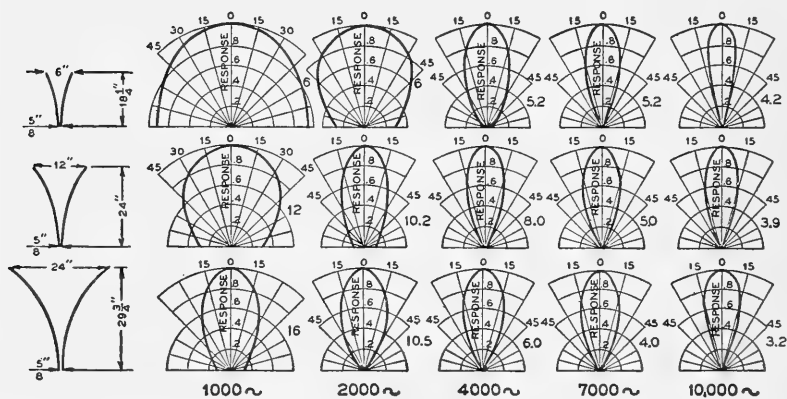

FIG. 2.9. The directional characteristics of a group of exponential horns, with a constant flare and throat diameter of  $\frac{5}{8}$  inches as a function of the mouth diameter. The number at the right of each polar diagram indicates the diameter of a circular piston which will yield the same directional characteristic. The polar graph depicts the pressure, at a fixed distance, as a function of the angle. The pressure for the angle  $0^\circ$  is arbitrarily chosen as unity. The direction corresponding to  $0^\circ$  is the axis of the horn. The directional characteristics in three dimensions are surfaces of revolution about the horn axis.

source or a vibrating piston may be used to predict approximately the directional characteristics of a direct radiator loud speaker.

**2.8. Exponential Horns.** — The directional characteristics of a horn depend upon the shape, mouth opening and the frequency. It is the purpose of this section to examine and consider some of the factors which influence the directional characteristics of a horn.

The phase and particle velocity of the various incremental areas which may be considered to constitute the mouth determines the directional characteristics of the horn. The particular complexion of the velocities and phase of these areas is governed by the flare and dimensions and shape of the mouth. In these considerations the mouth will be of circular cross section and mounted in a large flat baffle. The mouth of the horn plays a major role in determining the directional characteristics in the range where the wavelength is greater than the mouth diameter. The flare is the major factor in determining the directional characteristics in the range where the wavelength is less than the mouth diameter.

Figure 2.9 shows the effect of the diameter of the mouth for a constant flare upon the directional characteristics<sup>13,14</sup> of an exponential horn. At the side of each polar diagram is the diameter of a vibrating piston which will yield approximately the same directional characteristic. It will be seen that up to the frequency at which the wavelength becomes comparable to the mouth diameter, the directional characteristics are practically the same as those of a piston of the size of the mouth. Above this frequency the directional characteristics are practically independent of the mouth size and appear to be governed primarily by the flare.

To further illustrate the relative effects of the mouth and flare, Fig. 2.10 shows the effect of different rates of flare, for a constant mouth diameter, upon the directional characteristics of an exponential horn. These results also show that for the wavelengths larger than the mouth diameter, the directional characteristics are approximately the same as those of a vibrating piston of the same size as the mouth. Above this frequency the directional characteristics are broader than that obtained from a piston the size of the mouth. From another point of view, the diameter of the

---

<sup>13</sup> Olson, H. F., *RCA Review*, Vol. 1, No. 4, p. 68, 1937.

<sup>14</sup> Goldman, S., *Jour. Acous. Soc. Amer.*, Vol. 5, p. 181, 1934, reports the results of an investigation upon the directional characteristics of exponential horns at 15,000 and 25,000 cycles. A comparison can be made with the results shown in Figs. 2.9 and 2.10 by increasing the dimensions of the horns used by him to conform with those shown here and decreasing the frequency by the factor of increase in dimensions. Such a comparison shows remarkable agreement between the two sets of data.

piston which will yield the same directional characteristic is smaller than the mouth. These results also show that the directional characteristics vary very slowly with frequency at these smaller wavelengths. Referring to Fig. 2.10, it will be seen that for any particular high frequency, 4000, 7000 or 10,000 cycles per second, the directional characteristics become progressively sharper as the rate of flare decreases.

The results of Figs. 2.9 and 2.10 are applicable to other geometrically similar horns by changing the wavelength (or the reciprocal of the frequency) in the same ratio as the linear dimensions.

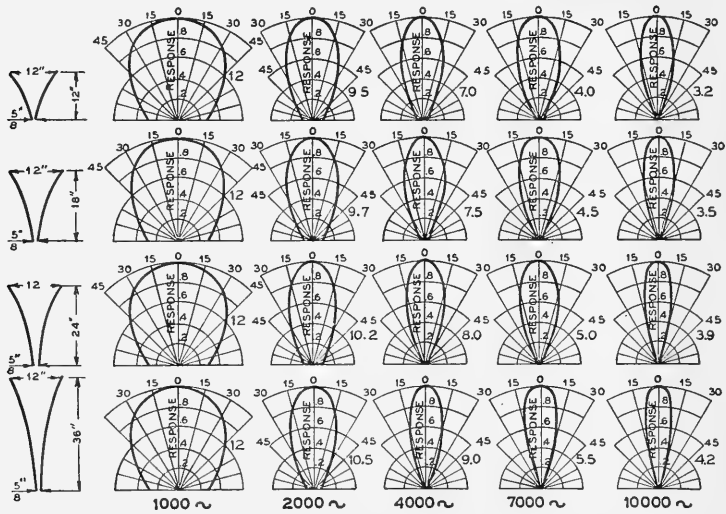

FIG. 2.10. The directional characteristics of a group of exponential horns, with a mouth diameter of 12 inches and a throat diameter of  $\frac{5}{8}$  inches, as a function of the flare. The number at the right of each polar diagram indicates the diameter of a circular piston which will yield the same directional characteristic. The polar graph depicts the pressure, at a fixed distance, as a function of the angle. The pressure for the angle  $0^\circ$  is arbitrarily chosen as unity. The direction corresponding to  $0^\circ$  is the axis of the horn. The directional characteristics in three dimensions are surfaces of revolution about the horn axis.

**2.9. Curved Surface Source.**—A sphere vibrating radially radiates sound uniformly outward in all directions. A portion of a spherical surface, large compared to the wavelength and vibrating radially, emits uniform sound radiation over a solid angle subtended by the surface at the center of curvature. To obtain uniform sound distribution over a certain solid angle, the radial air motion must have the same phase and amplitude over the spherical surface intercepted by the angle having its center of curvature at the vertex and the dimensions of the surface must be large compared

to the wavelength. When these conditions are satisfied for all frequencies, the response characteristic will be independent of the position within the solid angle.

A loud speaker<sup>15,16,17</sup> consisting of a large number of small horns with the axis passing through a common point will satisfy, for all practical purposes, the requirement of uniform phase and amplitude over the spherical surface formed by the mouths of the horns. A cellular or multihorn of this type is shown in Fig. 2.11A. This particular horn system consists of fifteen horns arranged in five vertical rows and three horizontal rows. The mouth opening of each horn is 8 × 8 inches. The horizontal and vertical angle between the axis of the individual horn is 17°.

The directional characteristics of a multihorn loud speaker may be predicted theoretically<sup>17</sup> from the directional characteristics of an in-

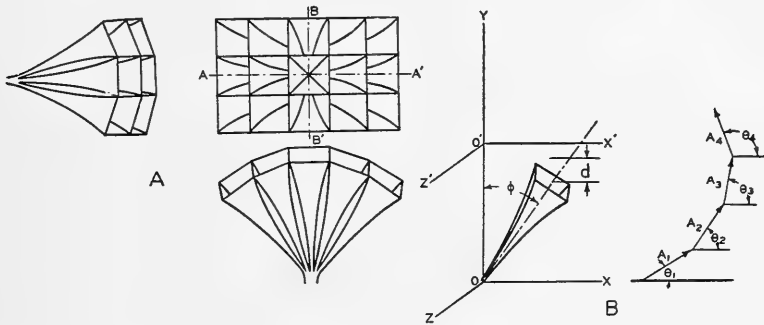

FIG. 2.11. A — a spherical radiating surface consisting of 15 individual exponential horns. B — geometry for predicting the directional characteristics of a cluster of small horns.

dividual horn and the geometrical configuration of the assembly of horns. Assume that the point of observation is located on the  $OY$  axis, Fig. 2.11B, at a distance several times the length of the horn. The amplitude of the vector contributed by an individual horn for the angle  $\phi$  can be determined from its individual directional characteristic. In this illustration, the plane  $XOZ$  is chosen as reference plane for the phase of the vector. The phase angle of the vector associated with an individual horn is

$$\theta = \frac{d}{\lambda} 360^\circ \tag{2.29}$$

<sup>15</sup> Wentz, E. C., and Thuras, A. L., *Jour. A. I. E. E.*, Vol. 53, No. 1, p. 17, 1934.  
<sup>16</sup> Hilliard, J. K., *Tech. Bull. Acad. Res. Council*, March, 1936.  
<sup>17</sup> Olson, H. F., *RCA Review*, Vol. 1, No. 4, p. 68, 1937.

where  $d$  = the distance between the center of the mouth of the horn and the reference plane  $X'O'Z'$ , in centimeters, and

$\lambda$  = wavelength, in centimeters.

The vectors, having amplitudes  $A_1, A_2, A_3, A_4$ , etc., determined from the directional characteristics and having phase angles  $\theta_1, \theta_2, \theta_3, \theta_4$ , etc., determined from equation 2.29, are added vectorially as shown in Fig. 2.11*B*. This method of predicting the directional characteristics assumes that there is no interaction between individual horns which changes the complexion of the velocities at the mouth from that which obtains when operating an individual horn. Obviously, this condition is not absolutely satisfied. Apparently, the discrepancy has no practical significance be-

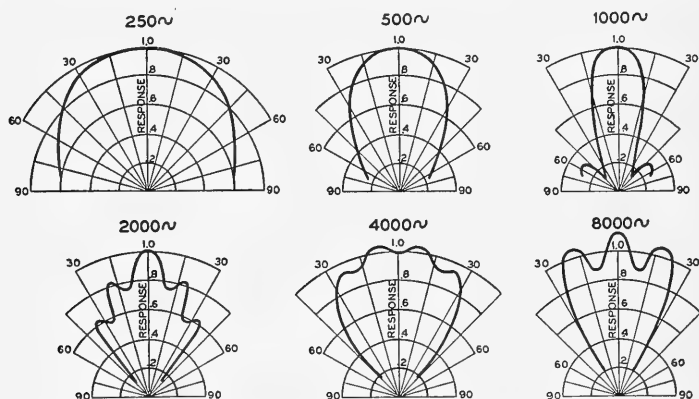

FIG. 2.12. Directional characteristics of the 15-cell cellular horn shown in Fig. 2.11*A* in a plane containing the line  $B-B'$  and the axis of the center horn. The polar graph depicts the pressure, at a fixed distance, as a function of the angle. The pressure for the angle  $0^\circ$  is arbitrarily chosen.

cause it has been found that this method of analysis agrees quite well with experimental results.

The directional characteristics of the cellular horn of Fig. 2.11*A* are shown in Figs. 2.12 and 2.13. Above 2000 cycles the dimensions of the total mouth surface are several wavelengths and the directional characteristics are fairly uniform and defined by the total angular spread. Where the dimensions are comparable to the wavelength the directional characteristics become very sharp, as shown by the polar curves for 500 and 1000 cycles. Then, as the dimensions of the surface become smaller than the wavelength, 250 cycles, the angular spread broadens, as is illustrated by the larger spread for the smaller vertical dimension when compared to the smaller spread for the larger horizontal dimension.

The directional characteristics of a cellular horn show a striking resem-

blance to those of an arc of the same angular spread. For example, the angular spread of the horn of Fig. 2.11 in the plane containing the line  $AA'$  and the axis is  $87\frac{1}{2}^\circ$ . This may be compared to the arc of Fig. 2.5. In this case  $\lambda/4$ ,  $\lambda/2$ ,  $\lambda$ ,  $2\lambda$ ,  $4\lambda$  and  $8\lambda$  will correspond to 145, 290, 580, 1160, 2320 and 4640 cycles. The angular spread in the plane containing the line  $BB'$  and the axis is  $52\frac{1}{2}^\circ$ . This may be compared to the  $60^\circ$  arc

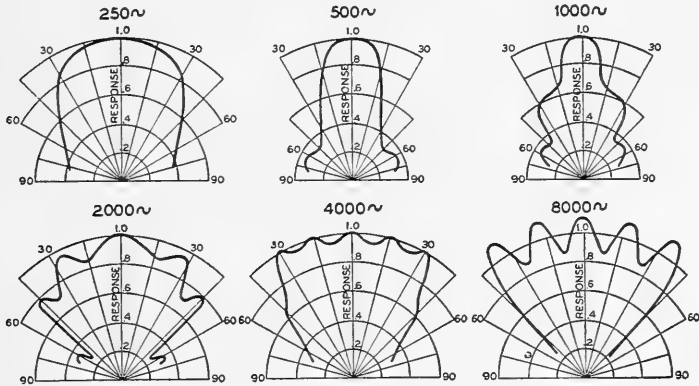

FIG. 2.13. Directional characteristics of the 15-cell cellular horn shown in Fig. 2.11A in a plane containing the line  $A-A'$  and the axis of the center horn. The polar graph depicts the pressure, at a fixed distance, as a function of the angle. The pressure for the angle  $0^\circ$  is arbitrarily chosen.

of Fig. 2.4 with the same relation between the wavelengths and frequencies as noted above. It will be seen that there is a marked resemblance between corresponding frequencies. Of course, there is some variation due to the fact that the frequencies do not correspond exactly. Further, there is some difference in the angular spread. For most spherical surfaces of this type the directional characteristics in various planes correspond very closely to the directional characteristics of the corresponding arc.

Directional systems are used for sound ranging both in air and in water. For the general subject of sound ranging and signaling, see Stewart and Lindsay, "Acoustics," D. Van Nostrand Company, New York City, and Olson and Massa, "Applied Acoustics," Blakiston Company, Philadelphia.

Equations 2.23 and 2.25 are applicable to plane and curved acoustic diffraction gratings. As in the case of optics the angle of the maxima shifts with the frequency. Gratings have been used in systems for the analysis of sound. The audio frequency is used to modulate a high frequency oscillator (50,000 cycles). The output of the oscillator drives a high frequency loud speaker which illuminates the grating with the high frequency sound. The sound diffracted from the grating is spread out in a spectrum corresponding to the original audio frequency sound. The sound in this spectrum is picked up by a small microphone, amplified, detected and fed to a suitable indicator. See Meyer, E., *Four. Acous. Soc. Amer.*, Vol. 7, No. 5, p. 88, 1935.

## CHAPTER III

### MECHANICAL VIBRATING SYSTEMS

**3.1. Introduction.** — The preceding chapters have been confined to the considerations of simple systems, point sources, homogeneous mediums and simple harmonic motion. Sources of sound such as strings, bars, membranes and plates are particularly liable to vibrate in more than one mode. In addition, there may be higher frequencies which may or may not be harmonics. The vibrations in solid bodies are usually termed as longitudinal, transverse or torsional. In most cases it is possible to confine the motion to one of these types of vibrations. For example, the vibrations of a stretched string are usually considered as transverse. It is also possible to excite longitudinal vibrations which will be higher in frequency. If the string is of a fairly large diameter torsional vibrations may be excited. The vibrations of a body are also affected by the medium in which it is emersed. Usually, in the consideration of a particular example it is necessary to make certain assumptions which will simplify the problem. The mathematical analysis of vibrating bodies is extremely complex and it is beyond the scope of this book to give a detailed analysis of the various systems. The reader is referred to the treatises which have been written on this subject for complete theoretical considerations. It is the purpose of this chapter to describe the most common vibrators in use to-day, to illustrate the form of the vibrations and to indicate the resonant frequencies.

**3.2. Strings.** — In all string instruments the transverse and not the longitudinal vibrations are used. In the transverse vibrations all parts of the string vibrate in a plane perpendicular to the line of the string. For the case to be described it is assumed: that the mass per unit length is a constant, that it is perfectly flexible (the stiffness being negligible) and that it is connected to massive nonyielding supports, Fig. 3.1. Since the string is fixed at the end, nodes will occur at these points. The fundamental frequency of the string is given by

$$f = \frac{1}{2l} \sqrt{\frac{T}{m}} \quad 3.1$$



where  $T$  = tension, in dynes,  
 $m$  = mass per unit length, in grams,  
 $l$  = length of the string, in centimeters.

The shape of the vibration of a string is sinusoidal. In addition to the fundamental, other modes of vibration may occur, the frequencies being 2, 3, 4, 5, etc., times the fundamental. The first few modes of vibration of a string are shown in Fig. 3.1. The points which are at rest are termed

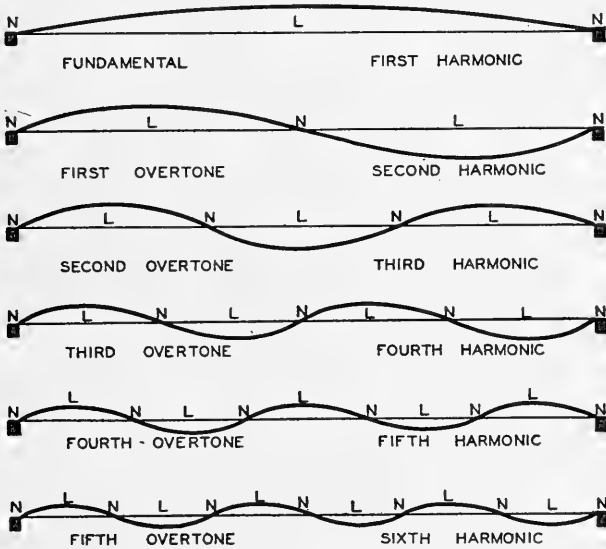

FIG. 3.1. Modes of vibration of a stretched string. The nodes and loops are indicated by  $N$  and  $L$ .

nodes and are marked  $N$ . The points between the nodes where the amplitude is a maximum are termed antinodes or loops and are marked  $L$ .

The above example is the simplest form of vibration of a string. A few of the problems which have been considered by different investigators<sup>1,2,3,4,5</sup> are as follows: nonuniform strings, loaded strings, stiff strings, nonrigid

<sup>1</sup> Rayleigh, "Theory of Sound," Macmillan and Co., London.  
<sup>2</sup> Crandall, "Theory of Vibrating Systems and Sound," D. Van Nostrand Co., New York.  
<sup>3</sup> Wood, "A Text Book of Sound," Bell and Sons, London.  
<sup>4</sup> Morse, "Vibration and Sound," McGraw Hill Book Co., New York.  
<sup>5</sup> Lamb, "Dynamical Theory of Sound," E. Arnold, London.

supports, the effect of damping and the effect of different types of excitation. These factors of course alter the form of vibration and the overtones.

**3.3. Transverse Vibration of Bars**<sup>1,3,4,5</sup>. — In the preceding section the perfectly flexible string was considered where the restoring force due to stiffness is negligible compared to that due to tension. The bar under no tension is the other limiting case, the restoring force being entirely due to stiffness. For the cases to be considered it is assumed that the bars are straight, the cross section is uniform and symmetrical about a central plane, and as in the case of the string, only the transverse vibrations will be considered.

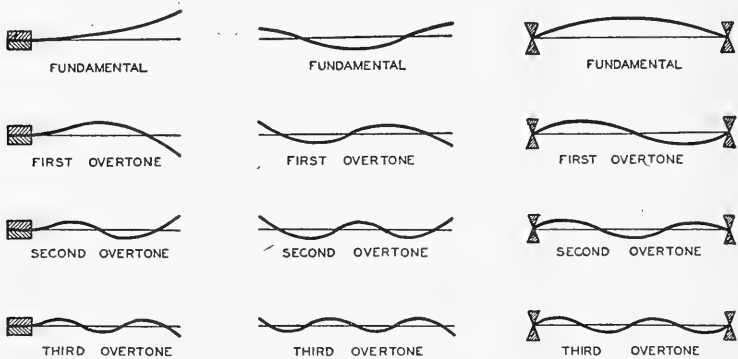

FIG. 3.2. Modes of transverse vibrations of a bar clamped at one end and free at the other, of a free bar and a bar supported at both ends.

*A. Bar Clamped at One End.* — Consider a bar clamped in a rigid support at one end with the other end free (Fig. 3.2). The fundamental frequency is given by

$$f_1 = \frac{.5596}{l^2} \sqrt{\frac{\mathcal{Q}K^2}{\rho}} \quad 3.2$$

where

$l$  = length of the bar, in centimeters,

$\rho$  = density, in grams per cubic centimeter,

$\mathcal{Q}$  = Young's modulus, in dynes per square centimeter, see Table 3.1, and

$K$  = radius of gyration.

For a rectangular cross section the radius of gyration is,

$$K = \frac{a}{\sqrt{12}}$$

where  $a$  = thickness of the bar, in centimeters, in the direction of vibration.  
 For a circular cross section

$$K = \frac{a}{2}$$

where  $a$  = radius of the bar in centimeters.

The modes of vibration of a bar clamped at one end are shown in Fig. 3.2. The table below gives the position of the nodes and the frequencies of the overtones.

No. of Tone	No. of Nodes	Distances of Nodes from Free End in Terms of the Length of the Bar	Frequencies as a Ratio of the Fundamental
1	0		$f_1$
2	1	.2261	$6.267f_1$
3	2	.1321, .4999	$17.55f_1$
4	3	.0944, .3558, .6439	$34.39f_1$

It will be seen that the overtones are not harmonics. The first overtone of a bar or reed has a higher frequency than the sixth harmonic of a string. The tuning fork is the most common example of a bar clamped at one end, because it can be considered to be two vibrating bars clamped at the lower ends. The overtone or the high frequency sound of a tuning fork is quickly damped out leaving almost a pure sound.

B. *Bar Free at Both Ends.* — Consider a perfectly free bar (Fig. 3.2). The fundamental frequency is given by

$$f_1 = \frac{1.133\pi}{l^2} \sqrt{\frac{2K^2}{\rho}} \tag{3.3}$$

where  $l$  = length of the bar, in centimeters.

All the other quantities are the same as in equation 3.2.

The modes of vibration of a perfectly free bar are shown in Fig. 3.2. The table which follows gives the position of the nodes and the frequencies of the overtones.

No. of Tone	No. of Nodes	Distances of Nodes from one End in Terms of the Length of the Bar	Frequencies as a Ratio of the Fundamental
1	2	.2242, .7758	$f_1$
2	3	.1321, .50, .8679	$2.756f_1$
3	4	.0944, .3558, .6442, .9056	$5.404f_1$
4	5	.0734, .277, .05, .723, .9266	$8.933f_1$

*C. Bar Clamped at Both Ends.* — Consider a bar rigidly clamped at both ends. The same tones are obtained as in the case of the perfectly free bar.

*D. Bar Supported at Both Ends.* — Consider a bar supported on knife edges at the two edges at the two ends (Fig. 3.2). The fundamental frequency is given by

$$f_1 = \frac{\pi}{2l^2} \sqrt{\frac{2K^2}{\rho}} \quad 3.4$$

where  $l$  = length of the bar, in centimeters.

All the other quantities are the same as in equation 3.2.

The overtones are

$$f_2 = 4f_1$$

$$f_3 = 9f_1$$

$$f_4 = 16f_1 \text{ etc.}$$

The nodes are equidistant as in case of the string.

**3.4. Circular Membrane**<sup>6,7,8,9,10</sup>. — The ideal membrane is assumed to be flexible, uniform and very thin in cross section, and stretched in all directions by a force which is not affected by motion of the membrane. Complete theoretical analyses have been made of square, rectangular and

<sup>6</sup> Lamb, "Dynamical Theory of Sound," E. Arnold, London.

<sup>7</sup> Rayleigh, "Theory of Sound," Macmillan and Co., London.

<sup>8</sup> Morse, "Vibration and Sound," McGraw Hill Book Co., New York.

<sup>9</sup> Wood, "A Text Book of Sound," Bell and Sons, London.

<sup>10</sup> Crandall, "Theory of Vibrating Systems and Sound," D. Van Nostrand Co., New York.

circular membranes. For cases of practical interest the membrane is rigidly clamped and stretched by a massive circular ring. The fundamental frequency, Fig. 3.3*A*, of a circular membrane is given by

$$f_{01} = \frac{.382}{R} \sqrt{\frac{T}{m}} \tag{3.5}$$

where  $m$  = mass, in grams per square centimeter of area,  
 $R$  = radius of the membrane, in centimeters, and  
 $T$  = tension, in dynes per centimeter.

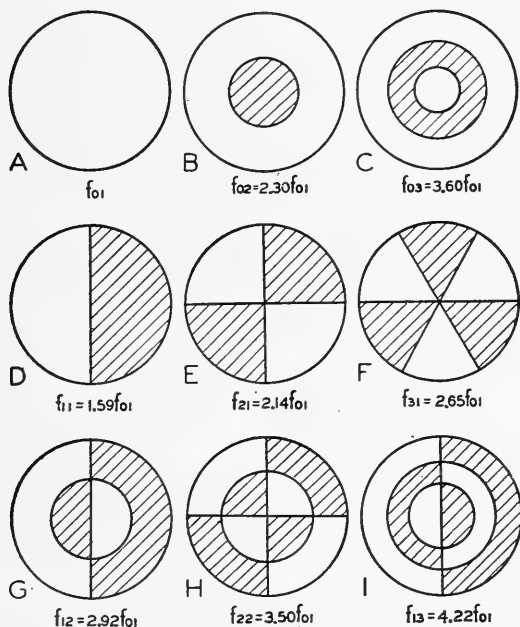

FIG. 3.3. Modes of vibration of a stretched circular membrane. Shaded segments are displaced in opposite phase to unshaded.

The fundamental vibration is with the circumference as a node and a maximum displacement at the center of the circle (Fig. 3.3*A*). The frequencies of the next two overtones with nodal circles are

$$f_{02} = 2.30f_{01}$$

$$f_{03} = 3.60f_{01}$$

and are shown in Figs. 3.3*B* and 3.3*C*. The frequencies of the first, second and third overtones with nodal diameters are

$$f_{11} = 1.59f_{01}$$

$$f_{21} = 2.14f_{01}$$

$$f_{31} = 2.65f_{01}$$

These nodes are shown in Figs. 3.3*D*, 3.3*E*, and 3.3*F*. Following these simpler forms of vibration are combinations of nodal circles and nodal diameters. The frequency of one nodal circle and one nodal diameter, Fig. 3.3*G*, is

$$f_{12} = 2.92f_{01}$$

The frequency of one nodal circle and two nodal diameters, Fig. 3.3*H*, is,

$$f_{22} = 3.50f$$

The frequency of two nodal circles and one nodal diameter, Fig. 3.3*I*, is

$$f_{13} = 4.22f_{01}$$

The stretched circular membrane is used in the condenser microphone. See Sec. 9.2*B*. The fundamental resonance frequency is placed at the upper limit of the frequency range. A resistive load is coupled to the diaphragm for damping the response in the neighborhood of the fundamental resonance frequency. This resistance is incorporated in the back plate which serves as the stationary electrode.

A stretched circular membrane is also used in all types of drums. In this case the air enclosure as well as the characteristics of the membrane controls the modes of vibration.

**3.5. Circular Clamped Plate**<sup>11, 12, 13, 14, 15</sup>. — Consider a plate under no tension, uniform in cross section and rigidly clamped by a massive circular ring. The fundamental frequency, Fig. 3.4*A*, of a circular plate is given by

$$f_{01} = \frac{.467t}{R^2} \sqrt{\frac{g}{\rho(1 - \sigma^2)}} \quad 3.6$$

<sup>11</sup> Rayleigh, "Theory of Sound," Macmillan and Co., London.

<sup>12</sup> Morse, "Vibration of Sound," McGraw Hill Book Co., New York.

<sup>13</sup> Wood, "A Text Book of Sound," Bell and Sons, London.

<sup>14</sup> Crandall, "Theory of Vibrating Systems and Sound," D. Van Nostrand Co., New York.

<sup>15</sup> Lamb, "Dynamical Theory of Sound," E. Arnold, London.

where  $t$  = thickness of the plate, in centimeters,  
 $R$  = radius of the plate up to the clamping boundary, in centimeters,  
 $\rho$  = density, in grams per cubic centimeters,  
 $\sigma$  = Poisson's ratio, and  
 $\mathcal{Q}$  = Young's modulus, in dynes per square centimeter. See Table 3.1.

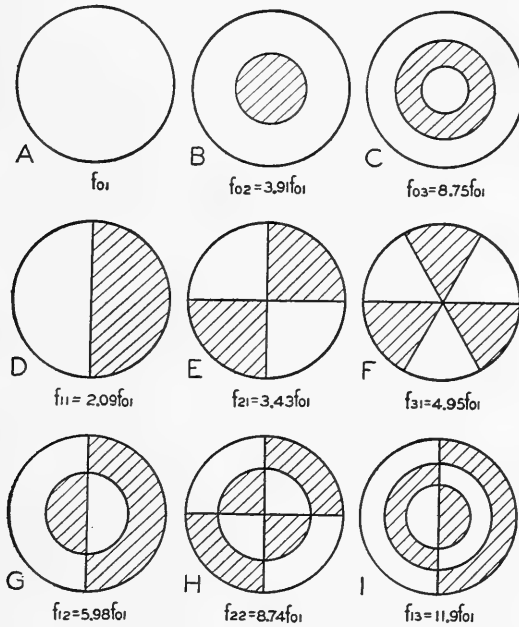

FIG. 3.4. Modes of vibration of a clamped circular plate. Shaded segments are displaced in opposite phase to unshaded.

The fundamental frequency is with the circumference as a node and a maximum displacement at the center.

The frequency of the next two overtones with nodal circles, Fig. 3.4B and 3.4C, are,

$$f_{02} = 3.91f_{01}$$

$$f_{03} = 8.75f_{01}$$

The frequencies of the first, second and third overtones with nodal diameters are

$$f_{11} = 2.09f_{01}$$

$$f_{21} = 3.43f_{01}$$

$$f_{31} = 4.95f_{01}$$

These nodes are shown in Figs. 3.4D, 3.4E and 3.4F.

Following these simpler forms of vibration are combinations of nodal circles and nodal diameters. The frequency of one nodal circle and one nodal diameter, Fig. 3.4G, is

$$f_{12} = 5.98f_{01}$$

The frequency of one nodal circle and two nodal diameters, Fig. 3.4H, is

$$f_{22} = 8.74f_{01}$$

The frequency of two nodal circles and one nodal diameter, Fig. 3.4I, is

$$f_{13} = 11.9f_{01}$$

The clamped plate is used in electromagnetic telephone receivers in which the steel diaphragm serves as the armature. See Sec. 10.2A. It is also used in carbon microphones. See Sec. 9.2A. Clamped plate diaphragms have been used in miniature condenser microphones. The disadvantage of a plate is the difficulty of mounting a thin plate to give a small mass per unit area for high sensitivity and still have sufficient stiffness to yield a high fundamental frequency.

**3.6. Longitudinal Vibration of Bars**<sup>16, 17, 18, 19</sup>. — Consider an entirely free rod of homogeneous material and constant cross section. The simplest mode of longitudinal vibration of a free rod is one in which a loop occurs at each end and a node in the middle, that is, when the length of the rod is one half wavelength. The fundamental frequency of longitudinal vibration of a free rod, Fig. 3.5, is

$$f_1 = \frac{1}{2l} \sqrt{\frac{\mathcal{Q}}{\rho}} \quad 3.7$$

where  $l$  = length of the rod, in centimeters,

$\rho$  = density of the material, in grams per cubic centimeter, and

$\mathcal{Q}$  = Young's modulus, in dynes per square centimeter. See Table 3.1.

The overtones of the free rod are harmonics of the fundamental. That is  $f_2 = 2f_1$ ,  $f_3 = 3f_1$ ,  $f_4 = 4f_1$ , etc., Fig. 3.5.

The fundamental resonance frequency occurs when the length of the rod is one-half wavelength. This fact provides a means of computing the velocity of sound when the density, Young's Modulus and the frequency

<sup>16</sup> Rayleigh, "Theory of Sound," Macmillan and Co., London.

<sup>17</sup> Morse, "Vibration and Sound," McGraw Hill Book Co., New York.

<sup>18</sup> Wood, "A Text Book of Sound," Bell and Sons, London.

<sup>19</sup> Lamb, "Dynamical Theory of Sound," E. Arnold, London.



are known, or the frequency of sound when the velocity, density and Young's Modulus are known.

Rods in which the longitudinal waves are excited by striking the ends are used as standards of high frequency sounds, 5000 and above, where a tuning fork is not very satisfactory.

Longitudinal waves in a rod may be set up by electromagnetic, electrostatic or magnetostriction means. In the first case, if the rod is of magnetic material and is held near an electromagnet in which an alternating current is flowing a longitudinal force will be set up in the rod. If the frequency of the driving current is continuously variable, the rod will be set into violent vibrations at the fundamental resonant frequency. If the

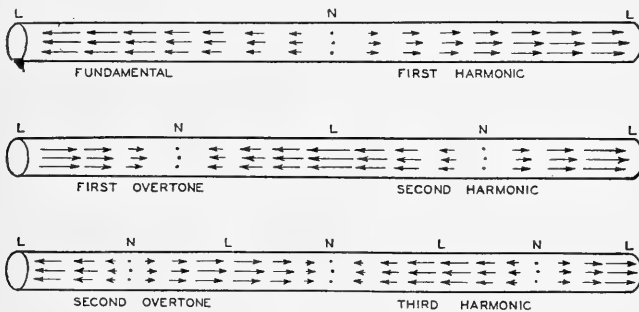

FIG. 3.5. Modes of longitudinal vibrations of a free rod. The nodes and loops are indicated by *N* and *L*.

plane end of a rod is placed near a metallic disk, the two plane surfaces may be used to serve as plates of a condenser. An alternating current sent through the condenser will cause an alternating force to be exerted upon the end of the rod. The rod will be sent into violent vibrations when the frequency of the impressed alternating current corresponds to the fundamental frequency or one of the overtones. Magnetization of magnetic materials produces small changes in the dimensions of these materials. A rod of magnetic material placed in a coil of wire will experience a change in length corresponding to the alterations in the actuating current. If the coil is part of the circuit of a vacuum tube oscillator, the rod will vibrate and the vacuum tube will oscillate at the fundamental frequency of the rod. Such a system is termed a magnetostriction sonic or super sonic generator<sup>20</sup> and may be used to produce sound waves in air or any other medium.

<sup>20</sup> Pierce, G. W., *Proc. Am. Acad. Arts and Sci.*, Vol. 63, p. 1, 1928.

**3.7. Torsional Vibration of Bars** <sup>21, 22</sup>. — A solid bar or tube may be twisted about the axis of the rod in such a manner that each transverse section remains in its own plane. If the section is not circular there will be motion parallel to the axis of the bar. Consider an entirely free rod of homogeneous material and circular cross section. The simplest or fundamental mode of torsional vibration occurs when there is a node in the

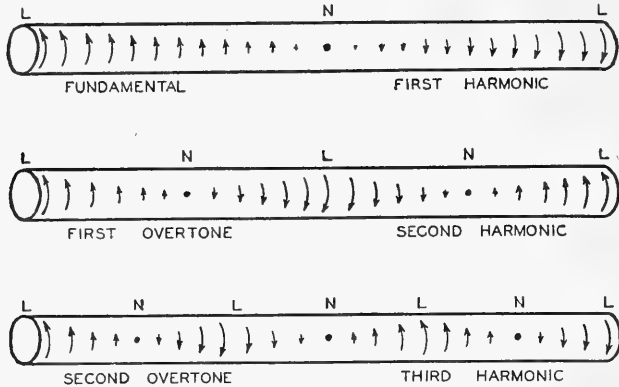

FIG. 3.6. Modes of torsional vibration of a free rod. The nodes and loops are indicated by *N* and *L*.

middle and a loop at each end, that is, when the length of the rod is one half wavelength. The fundamental resonant frequency, Fig. 3.6, is given by

$$f_1 = \frac{1}{2l} \sqrt{\frac{\mathcal{Q}}{2\rho(\sigma + 1)}} \quad 3.8$$

where  $l$  = length of the rod, in centimeters,

$\rho$  = density, in grams per cubic centimeter,

$\mathcal{Q}$  = Young's modulus, in dynes per square centimeters, and

$\sigma$  = Poisson's ratio. See Table 3.1.

The overtones, as in the case of longitudinal vibrations, are harmonics of the fundamental. That is,  $f_2 = 2f_1$ ,  $f_3 = 3f_1$ ,  $f_4 = 4f_1$ , etc. The nodes and antinodes for the various harmonics are formed as in the case of longitudinal vibrations.

Torsional vibrations may be set up in bars by any means which applies tangential forces to the free end. From a comparison of the longitudinal and torsional vibrations in the same bar, Poisson's ratio may be determined.

<sup>21</sup> Wood, "A Text Book of Sound," Bell and Sons, London.

<sup>22</sup> Rayleigh, "Theory of Sound," Macmillan and Co., London.

**3.8. Open and Closed Pipes.** — The vibrations of a column of gas or fluid in a cylindrical tube are analogous to the longitudinal vibrations in a solid bar. For the open pipe there must be a loop of displacement at the open ends.

The fundamental resonant frequency of a pipe, open at both ends, Fig. 3.7, is

$$f = \frac{c}{2l} \quad 3.9$$

where  $l$  = length of the pipe, in centimeters, and

$c$  = velocity of sound, in centimeters per second. See Table 1.1.

The overtones of an open pipe are harmonics of the fundamental. That is  $f_2 = 2f_1$ ,  $f_3 = 3f_1$ ,  $f_4 = 4f_1$ , etc.

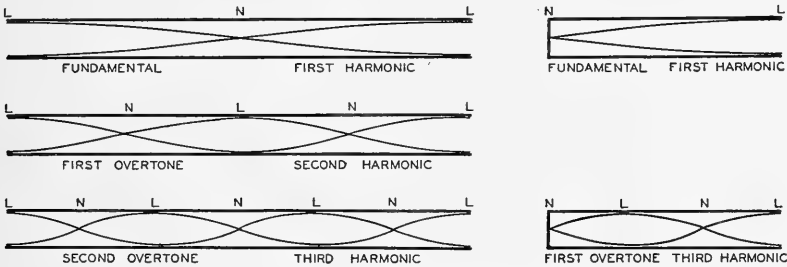

Fig. 3.7. Modes of vibration of the air column in a pipe open at both ends and in a pipe closed at one end and open at the other end. The velocity nodes and loops are indicated by  $N$  and  $L$ .

The fundamental resonant frequency of a pipe closed at one end and open at the other end, Fig. 3.7, is

$$f = \frac{c}{4l} \quad 3.10$$

The overtones of the pipe closed at one end are the odd harmonics. That is  $f_2 = 3f_1$ ,  $f_3 = 5f_1$ , etc.

In the above examples the end connection has been omitted. Rayleigh<sup>23</sup> shows the added length at the open end to be  $.82R$  where  $R$  is the radius of the pipe. If the pipe is terminated in a large flange the end connection will be that given in Sec. 5.7.

Organ pipes and whistles have been built to cover the range from 16

<sup>23</sup> Rayleigh, "Theory of Sound," Macmillan and Co., London.

cycles to 30,000 cycles. The frequency of open and closed pipes may be computed from the above equations. The sound vibrations in the pipe are set up by the stream of air which is controlled by the vibration in the pipe. It is an oscillatory system fed by a direct current of air or gas.

TABLE 3.1 YOUNG'S MODULUS  $\mathcal{Q}$ , IN DYNES PER SQUARE CENTIMETER, POISSON'S RATIO,  $\sigma$  AND DENSITY  $\rho$ , IN GRAMS PER CUBIC CENTIMETER

Material	$\mathcal{Q}$	$\sigma$	$\rho$
Aluminum	$7 \times 10^{11}$	.33	2.7
Brass	$10 \times 10^{11}$	.33	8.4
Bronze (phosphor)	$12 \times 10^{11}$	.31	8.8
Copper	$11 \times 10^{11}$	.35	8.9
Glass	$8 \times 10^{11}$	.25	2.6
Iron (wrought)	$20 \times 10^{11}$	.28	7.6
Lead	$1.7 \times 10^{11}$	.43	11.3
Magnesium	$4 \times 10^{11}$	.33	1.7
Nickel	$21 \times 10^{11}$	.31	8.0
Silver	$7 \times 10^{11}$	.37	10.4
Steel	$19 \times 10^{11}$	.27	7.7
Tin	$5 \times 10^{11}$	.33	7.3
Tungsten	$35 \times 10^{11}$	.17	19.0
Zinc	$9 \times 10^{11}$	.17	7.0

## CHAPTER IV

### ELECTRICAL, MECHANICAL AND ACOUSTICAL ANALOGIES

**4.1. Introduction.** — Systems in use to-day for sound reproduction include mechanical, acoustical, electro-acoustical, electro-mechanical, mechano-acoustical and electro-mechano-acoustical systems. Almost any work involving mechanical or acoustical systems also includes electrical systems and electric circuit theory. Acoustical measurements are usually made with electrical instruments and in terms of electrical quantities. Ultimately the electrical units must be compared with acoustical and mechanical units. In general, anyone in any manner connected with sound reproduction must be familiar with electric circuit theory. Therefore, it is logical, whenever possible and convenient, to treat mechanical and acoustical problems by the same mathematical theory as is used in electric circuit problems.

Electric circuit theory is the branch of electromagnetic theory which deals with electrical oscillations in linear electrical networks. An electrical network is a connected set of separate circuits termed branches or meshes. These branches or meshes are composed of elements. Resistance, inductance and capacitance are termed elements.

Mathematically the elements in an electrical circuit are the coefficients in the differential equations. The equations of electric circuit theory may be based upon Maxwell's dynamical theory. In this case the network forms a dynamical system in which the currents play the role of velocities. In the same way the coefficients in the differential equations of a mechanical or acoustical system may be looked upon as mechanical or acoustical elements. In other words, every electrical, mechanical or acoustical system may be considered as a combination of electrical, mechanical or acoustical elements. Therefore, any mechanical or acoustical system may be reduced to an electrical network. Then the problem may be solved by electric circuit theory.

It is the purpose of this chapter to consider electrical, mechanical and acoustical elements and the combination of elements and to indicate analogies between the elements and connections in the three systems.

**4.2. Resistance.** — A. *Electrical Resistance.* — Resistance is the circuit element which causes dissipation.

Electrical resistance  $r_E$ , in abohms, is defined by Ohm's law

$$r_E = \frac{e}{i} \quad 4.1$$

where  $e$  = voltage across the resistance, in abvolts,  
 $i$  = current through the resistance, in abamperes.

**B. Mechanical Resistance.** — In a mechanical system dissipation is due to friction. Mechanical resistance  $r_M$ , in mechanical ohms, is defined as

$$r_M = \frac{f_M}{u} \quad 4.2$$

where  $f_M$  = applied mechanical force, in dynes, and  
 $u$  = velocity at the point of application of the force, in centimeters per second.

**C. Acoustical Resistance.** — In an acoustical system dissipation may be due to fluid resistance or radiation resistance. Fluid resistance is due to viscosity. See Sec. 5.2. In the case of fluid flowing through a pipe with a velocity of one cubic centimeter per second, resistance is represented by the pressure drop along the pipe. The case of radiation resistance is discussed in Sec. 5.7.

Acoustical resistance  $r_A$ , in acoustical ohms, is defined as,

$$r_A = \frac{p}{U} \quad 4.3$$

where  $p$  = pressure, in dynes per square centimeter, and  
 $U$  = volume current, in cubic centimeters per second.

Volume current (sometimes termed volume velocity) is the rate of change of volume displacement with time. In other words, volume current is the linear velocity over an area multiplied by the area.

**4.3. Inductance, Inertia, Inertance.** — **A. Inductance.** — Inductance is the electrical circuit element which opposes a change in current. Inductance is defined as

$$e = L \frac{di}{dt} \quad 4.4$$

where  $L$  = inductance, in abhenries,  
 $e$  = electromotive or driving force, in abvolts, and  
 $\frac{di}{dt}$  = rate of change of current, in abamperes per second

Equation 4.4 states that the driving force or electromotive force across an inductance is proportional to the inductance and the rate of change of current.

B. *Inertia*. — Mass is the mechanical element which opposes a change in velocity. Mass is defined as

$$f_M = m \frac{du}{dt} \quad 4.5$$

where  $m$  = mass in grams,

$\frac{du}{dt}$  = acceleration, in centimeters per second per second, and

$f_M$  = driving force, in dynes.

Equation 4.5 states that the driving force applied to the mass is proportional to the mass and the rate of change of velocity.

C. *Inertance*. — Inertance is the acoustical element which opposes a change in volume current. Inertance is defined as

$$p = M \frac{dU}{dt} \quad 4.6$$

where  $M$  = inertance, in grams per square centimeter per square centimeter,

$\frac{dU}{dt}$  = change in volume current, in cubic centimeters per second per second, and

$p$  = driving pressure, in dynes per square centimeter.

Equation 4.6 states that the driving pressure applied to an inertance is proportional to the inertance and the rate of change of volume current.

**4.4. Capacitance, Compliance, Acoustic Capacitance.** — A. *Electrical Capacitance*. — Capacitance is the electrical circuit element which opposes a change in voltage. Capacitance is defined as

$$i = C_E \frac{de}{dt} \quad 4.7$$

where  $C_E$  = capacitance, in abfarads,

$\frac{de}{dt}$  = rate of change in voltage, in abvolts per second, and

$i$  = current, in abamperes.

Equation 4.7 may be written

$$e = \frac{1}{C_E} \int idt = \frac{q}{C_E} \quad 4.8$$

where  $q$  = charge on the capacitance, in abcoulombs.

Equation 4.8 states that the charge on a condenser is proportional to the capacitance and the applied electromotive force.

B. *Mechanical Compliance*. — Compliance is the mechanical element which opposes a change of the applied force. Compliance may be defined as

$$f_M = \frac{x}{C_M} \quad 4.9$$

where  $C_M$  = compliance, in centimeters per dyne,

$x$  = displacement, in centimeters, and

$f_M$  = applied force, in dynes.

Equation 4.9 states that the displacement of a compliance is proportional to the compliance and the applied force.

C. *Acoustical Capacitance*. — Acoustical capacitance is the acoustic element which opposes a change in the applied pressure. The pressure, in dynes per square centimeter, in terms of the condensation, from equation 1.21 is

$$p = c^2 \rho s \quad 4.10$$

where  $c$  = velocity, in centimeters per second,

$\rho$  = density, in grams per cubic centimeter, and

$s$  = condensation.

The condensation in a volume  $V$  due to a change of volume  $dV$  is

$$s = \frac{dV}{V} \quad 4.11$$

The change in volume is

$$dV = Sx \quad 4.12$$

where  $x$  = displacement, in centimeters, over the area  $S$ , in square centimeters.

The volume displacement, in cubic centimeters, is,

$$X = Sx \quad 4.13$$



From equations 4.10, 4.11, 4.12 and 4.13 the pressure is

$$p = \frac{\rho c^2}{V} X \quad 4.14$$

From the definition of acoustic capacitance, equation 4.14, the acoustic capacitance of a volume is,

$$C_A = \frac{V}{\rho c^2} \quad 4.15$$

Then equation 4.14 may be written,

$$p = \frac{X}{C_A} \quad 4.16$$

Equation 4.16 states that the volume displacement in an acoustic capacitance is proportional to the pressure and the acoustic capacitance.

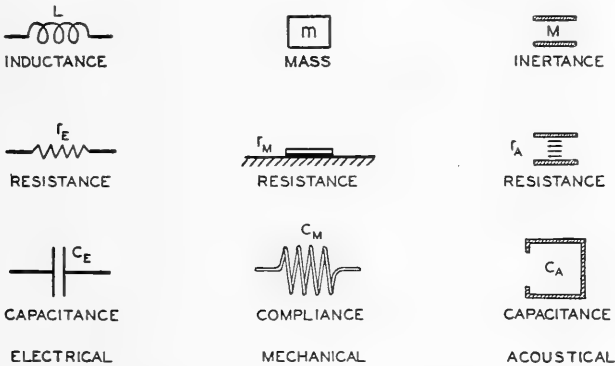

FIG. 4.1. Graphical representation of the three basic elements in electrical, mechanical and acoustical systems.

#### 4.5. Representation of Electrical, Mechanical and Acoustical Elements.

— Electrical, mechanical and acoustical elements have been defined in the preceding sections. Figure 4.1 illustrates schematically the three elements in each of the three systems.

Mechanical resistance is represented by sliding friction which causes dissipation. Acoustic resistance is represented by narrow slits which cause dissipation due to viscosity when fluid is forced through the slits. These elements are analogous to resistance in the electrical system.

Inertia in the mechanical system is represented by a mass. Inertance

in the acoustical system is represented as the fluid contained in a tube in which all the particles move with the same phase when actuated by a force due to pressure. These elements are analogous to inductance in the electrical system.

Compliance in the mechanical system is represented as a spring. Acoustic capacitance is represented as a volume which acts as a stiffness. These elements are analogous to capacitance in the electrical system.

**4.6. Electrical, Mechanical and Acoustical Systems of One Degree of Freedom.** — In the preceding sections the fundamental elements in each of the three systems have been defined. From these definitions it is evident that friction, mass and compliance govern the movements of physical bodies in the same manner that resistance, inductance and capacitance govern the movement of electricity. In any dynamical system there are

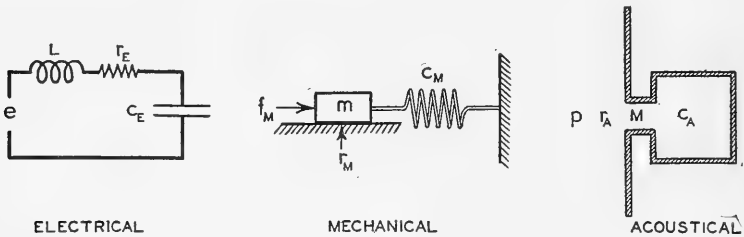

FIG. 4.2. Electrical, mechanical and acoustical systems of one degree of freedom. (Courtesy of The Blakiston Company from Olson and Massa, "Applied Acoustics.")

two distinct problems, namely: the derivation of the differential equations from the statement of the problem, and the physical laws and the solution of the differential equation. Mathematically the elements in the electrical circuit are the coefficients in the differential equation. In the same way the coefficients in the differential equations of a mechanical or acoustical system may be looked upon as mechanical or acoustical elements. It is the purpose of this section to describe the action of electrical and acoustical systems from this viewpoint. An electrical, mechanical and acoustical system of one degree of freedom is shown in Fig. 4.2. In one degree of freedom the activity in every element of the system may be expressed in terms of one variable. In the electrical system an inductance  $L$ , a resistance  $r_E$ , a capacitance  $C_E$  and an electromotive force  $e$  are connected in series. In the mechanical system, a driving force  $f_M$  acts upon a particle of mass  $m$  fastened to a spring  $C_M$  and sliding upon a plate with a frictional force which is proportional to the velocity and designated as  $r_M$ . In the acoustical system, an impinging sound wave of pressure  $p$  acts upon an

inertance  $M$  comprising the air in the tubular opening which is connected to the volume  $C_A$ . The acoustical resistance  $r_A$  is due to radiation.

A. *Kinetic Energy*. — The kinetic energy, in ergs, stored in the magnetic field of the electrical circuit is

$$T_{KE} = \frac{1}{2}Li^2 \quad 4.17$$

where  $L$  = inductance, in abhenries, and

$i$  = current through the inductance  $L$ , in abamperes.

The kinetic energy, in ergs, stored in the mass of the mechanical system is

$$T_{KM} = \frac{1}{2}m\dot{x}^2 \quad 4.18$$

where  $m$  = mass, in grams, and

$\dot{x}$  = velocity of the mass  $m$ , in centimeters per second.

The kinetic energy, in ergs, stored in the inertance of the acoustical system is

$$T_{KA} = \frac{1}{2}M\dot{X}^2 \quad 4.19$$

where  $M = m/S^2$ , the inertance,

$m$  = mass of air in the opening, in grams,

$S$  = cross-sectional area of the opening, in square centimeters,

$\dot{X} = S\dot{x}$ , and

$\dot{x}$  = velocity of the air particles in the opening, in centimeters per second.

It is assumed that all the air particles in the opening move with the same phase.

B. *Potential Energy*. — The potential energy, in ergs, stored in the electric field of the electrical circuit is

$$V_{PE} = \frac{1}{2} \frac{q^2}{C_E} \quad 4.20$$

where  $C_E$  = capacitance, in abfarads, and

$q$  = charge on the capacitance, in abcoulombs.

The potential energy, in ergs, stored in the compliance or spring of the mechanical system is

$$V_{PE} = \frac{1}{2} \frac{x^2}{C_M} \quad 4.21$$

where  $C_M = 1/s$ , compliance of the spring, in centimeters per dyne,

$s$  = stiffness of the spring, in dynes per centimeter, and

$x$  = displacement, in centimeters.

The potential energy, in ergs, stored in the capacitance of the acoustical system is

$$V_{PA} = \frac{1}{2} \frac{X^2}{C_A} \quad 4.22$$

where  $X$  = volume displacement, in cubic centimeters,

$$C_A = \frac{V}{\rho c^2}, \text{ acoustical capacitance,}$$

$V$  = volume of the cavity, in cubic centimeters,

$\rho$  = density of air, in grams per cubic centimeter, and

$c$  = velocity of sound, in centimeters per second.

The total energy, in ergs, stored in the three systems may be written,

$$W_E = T_{KE} + V_{PE} = \frac{1}{2} Li^2 + \frac{1}{2} \frac{q^2}{C_E} \quad 4.23$$

$$W_M = T_{KM} + V_{PM} = \frac{1}{2} m\dot{x}^2 + \frac{1}{2} \frac{x^2}{C_M} \quad 4.24$$

$$W_A = T_{KA} + V_{PA} = \frac{1}{2} M\dot{X}^2 + \frac{1}{2} \frac{X^2}{C_A} \quad 4.25$$

The rate of change of energy, in ergs per second, in the three systems may be written

$$\frac{dW_E}{dt} = Li \frac{di}{dt} + \frac{q\dot{q}}{C_E} = L\dot{q}\ddot{q} + \frac{q\dot{q}}{C_E} \quad 4.26$$

$$\frac{dW_M}{dt} = m\dot{x}\ddot{x} + \frac{x\dot{x}}{C_M} \quad 4.27$$

$$\frac{dW_A}{dt} = M\dot{X}\ddot{X} + \frac{X\dot{X}}{C_A} \quad 4.28$$

C. *Dissipation.* — The rate at which electromagnetic energy, in ergs per second, is converted into heat is,

$$D_E = r_E i^2 \quad 4.29$$

where  $r_E$  = resistance, in abohms, and

$i$  = current, in abamperes.

Assume that the frictional force  $f_M$ , in dynes, acting upon the mass  $m$  as it slides back and forth is proportional to the velocity as follows,

$$f_M = r_M \dot{x} \quad 4.30$$

where  $r_M$  = mechanical resistance, in mechanical ohms, and  
 $\dot{x}$  = velocity, in centimeters per second.

The rate at which mechanical energy, in ergs per second, is converted into heat is

$$D_M = f_M \dot{x} = r_M \dot{x}^2 \quad 4.31$$

The rate at which acoustical energy, in ergs per second, is radiated is

$$D_A = r_A \dot{X}^2 \quad 4.32$$

where  $r_A$  = acoustical radiation resistance, in acoustical ohms, and  
 $\dot{X}$  = volume current, in cubic centimeters per second.

Acoustic radiation resistance will be considered in Sec. 5.7.

D. *Equations of Motion.* — The rate at which work is done by the applied electromotive force is  $\dot{q}E\epsilon^{j\omega t} = e\dot{q}$ . The rate at which work is done by the applied mechanical force is  $\dot{x}F\epsilon^{j\omega t} = f_M\dot{x}$ . The rate at which work is done by the applied acoustical pressure is  $\dot{X}P\epsilon^{j\omega t} = p\dot{X}$ .

The rate of decrease of energy ( $T_K + V_P$ ) of the system plus the rate at which work is done on the system by the external forces must equal the rate of dissipation of energy. Writing this sentence mathematically yields the equations of motion for the three systems.

Electrical

$$L\dot{q}\ddot{q} + r_E\dot{q}^2 + \frac{q\dot{q}}{C_E} = E\epsilon^{j\omega t}\dot{q} \quad 4.33$$

$$L\ddot{q} + r_E\dot{q} + \frac{q}{C_E} = E\epsilon^{j\omega t} \quad 4.34$$

Mechanical

$$m\dot{x}\ddot{x} + r_E\dot{x}^2 + \frac{x\dot{x}}{C_M} = F\epsilon^{j\omega t}\dot{x} \quad 4.35$$

$$m\ddot{x} + r_E\dot{x} + \frac{x}{C_M} = F\epsilon^{j\omega t} \quad 4.36$$

Acoustical

$$M\dot{X}\ddot{X} + r_A\dot{X}^2 + \frac{XX}{C_A} = P\epsilon^{j\omega t}\dot{X} \quad 4.37$$

$$M\ddot{X} + r_A\dot{X} + \frac{X}{C_A} = P\epsilon^{j\omega t} \quad 4.38$$

The steady state solution of equations 4.34, 4.36 and 4.38 are:

Electrical

$$\dot{q} = i = \frac{E\epsilon^{j\omega t}}{r_E + j\omega L - \frac{j}{\omega C_E}} = \frac{e}{z_E} \quad 4.39$$

Mechanical

$$\dot{x} = \frac{F\epsilon^{j\omega t}}{r_M + j\omega M - \frac{j}{\omega C_M}} = \frac{f_M}{z_M} \quad 4.40$$

Acoustical

$$\dot{X} = \frac{P\epsilon^{j\omega t}}{r_A + j\omega M - \frac{j}{\omega C_A}} = \frac{p}{z_A} \quad 4.41$$

The vector electrical impedance is

$$z_E = r_E + j\omega L - \frac{j}{\omega C_E} \quad 4.42$$

The vector mechanical impedance is,

$$z_M = r_M + j\omega m - \frac{j}{\omega C_M} \quad 4.43$$

The vector acoustical impedance is

$$z_A = r_A + j\omega M - \frac{j}{\omega C_A} \quad 4.44$$

Electrical impedance is the complex quotient of the voltage by the current. The unit is the abohm.

Electrical resistance is the real component of the electrical impedance. The unit is the abohm.

Electrical reactance is the imaginary component of the electrical impedance. The unit is the abohm.

*Electrical abohm.* An electrical resistance, reactance or impedance is

said to have a magnitude of one abohm when a voltage of one abvolt produces a current of one abampere.

Mechanical impedance is the complex quotient of the force by the linear velocity. The unit is the mechanical ohm.

Mechanical resistance is the real component of the mechanical impedance. The unit is the mechanical ohm.

Mechanical reactance is the imaginary component of the mechanical impedance. The unit is the mechanical ohm.

*Mechanical ohm.* A mechanical resistance, reactance or impedance is said to have a magnitude of one mechanical ohm when a force of one dyne produces a velocity of one centimeter per second.

Acoustical impedance is the complex quotient of the pressure by the volume current. The unit is the acoustical ohm.

Acoustical resistance is the real component of the acoustical impedance. The unit is the acoustical ohm.

Acoustical reactance is the imaginary component of the acoustical impedance. The unit is the acoustical ohm.

*Acoustical ohm.* An acoustical resistance, reactance, or impedance is said to have a magnitude of one acoustical ohm when a pressure of one dyne per square centimeter produces a volume current of one cubic centimeter per second.

E. *Resonant Frequency.* — For a certain value of  $L$  and  $C_E$ ,  $m$  and  $C_M$ , and  $M$  and  $C_A$  there will be a certain frequency at which the imaginary component of the impedance is zero. This frequency is called the resonant frequency. At this frequency the ratio of the current to the applied voltage or the ratio of the velocity to the applied force or the ratio of the volume current to the applied pressure is a maximum. At the resonant frequency the current and voltage, the velocity and force, and the pressure and volume current are in phase.

The resonant frequency  $f_r$  in the three systems is,

Electrical

$$f_r = \frac{1}{2\pi\sqrt{LC_E}} \quad 4.45$$

Mechanical

$$f_r = \frac{1}{2\pi\sqrt{mC_M}} \quad 4.46$$

Acoustical

$$f_r = \frac{1}{2\pi\sqrt{MC_A}} \quad 4.47$$

**4.7. Electrical, Mechanical and Acoustical Systems of Two Degrees of Freedom.** — The simple resonant system of one degree of freedom has been considered in the preceding section. It is the purpose of this section to consider the parallel electrical circuit and the mechanical and electrical equivalents.

*The Electrical System*

The relation of the currents in Fig. 4.3 are

$$i_1 = i_2 + i_3 \quad 4.48$$

The voltage across the capacitance is

$$e = \frac{q_2}{C_E} \quad 4.49$$

The voltage across the inductance and resistance in series is

$$e = L \frac{di_3}{dt} + r_E i_3 \quad 4.50$$

Since  $\dot{q} = i$ , equation 4.50 may be written

$$e = L\dot{q}_3 + r_E \dot{q}_3 \quad 4.51$$

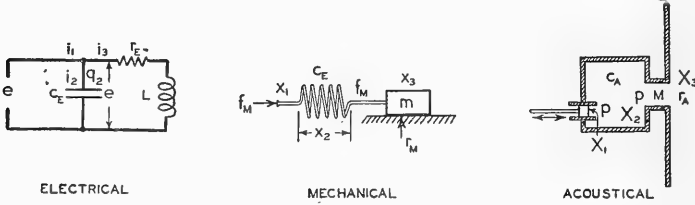

FIG. 4.3. Electrical, mechanical and acoustical systems of two degrees of freedom.

*The Mechanical System*

The total displacement in the mechanical system of Fig. 4.3 is the sum of the displacement of the mass  $m$  and the displacement of the compliance  $c_M$ .

$$x_1 = x_2 + x_3 \quad 4.52$$

Differentiating equation 4.52 with respect to the time, the velocities are

$$\dot{x}_1 = \dot{x}_2 + \dot{x}_3 \quad 4.53$$

The force applied to the spring is

$$f_M = \frac{x_2}{C_M} \quad 4.54$$



The force applied to the mass and resistance is

$$f_M = m\ddot{x}_3 + r_M\dot{x}_3 \quad 4.55$$

#### *The Acoustical System*

The total volume displacement, in the acoustical system of Fig. 4.3, is the sum of the volume displacement of the inertance  $M$  and the volume displacement of the acoustic capacitance  $c_A$ .

$$X_1 = X_2 + X_3 \quad 4.56$$

The total volume displacement is the volume displacement of the vibrating piston. The vibrating piston is not a part of the acoustical system. It is merely the sound pressure source which produces the sound pressure  $p$ .

Differentiating equation 4.56 with respect to the time, the volume currents are

$$\dot{X}_1 = \dot{X}_2 + \dot{X}_3 \quad 4.57$$

The pressure applied to the capacitance is

$$p = \frac{X_2}{c_A} \quad 4.58$$

The pressure applied to the inertance and acoustic resistance is

$$p = M\ddot{X}_3 + r_A\dot{X}_3 \quad 4.59$$

A comparison of the coefficients of equations 4.49, 4.51, 4.54, 4.55, 4.58 and 4.59 shows again that resistance, inductance and capacitance is equivalent to resistance, mass and compliance in the mechanical system and to resistance, inertance and acoustic capacitance in the acoustical system. A comparison of equations 4.48, 4.53 and 4.57 shows that currents in the electrical system are analogous to velocities in the mechanical system and to volume currents in the acoustical system.

The equations for the impedance of a parallel electrical circuit are given in all text-books on electrical engineering and will not be repeated. The performance of the mechanical or acoustical system of Fig. 4.3 may be predicted by employing the equations for the electrical circuit of Fig. 4.3.

**4.8. Electrical, Mechanical and Acoustical Systems of Three Degrees of Freedom.** — A system of three degrees of freedom is shown in Fig. 4.4. The currents in the different branches of the electrical system may be obtained by using the rules and formulas of the electrical circuit theory. From the differential equations of the electrical, mechanical and acoustical systems it can be shown  $L_1$ ,  $L_2$ ,  $C_{E1}$ ,  $C_{E2}$  and  $r_E$  in the electrical system are

equivalent to  $m_1$ ,  $m_2$ ,  $C_{M1}$ ,  $C_{M2}$  and  $r_M$  in the mechanical system and  $M_1$ ,  $M_2$ ,  $C_{A1}$ ,  $C_{A2}$  and  $r_A$  in the acoustical system. These equations also show that the currents in the electrical system are equivalent to the velocities in the mechanical system and to the volume currents in the acoustical system. Therefore, the action of a mechanical or acoustical system may be predicted by employing the equivalent electrical circuit of these systems and solving the circuit by the conventional electrical theory.

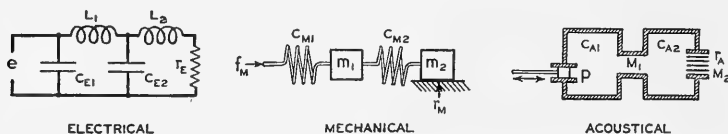

FIG. 4.4. Electrical, mechanical and acoustical systems of three degrees of freedom.

**4.9. Corrective Networks.** — A. *Introduction.* — A corrective network is a structure which has a transmission frequency characteristic that is more or less gradual in slope. Such a characteristic is obtained when an inductance, capacitance or the combination of both are shunted across a line. Another type of corrective network is an inductance capacitance or combination of both connected in series with a line. Various types of resistance networks may be used as attenuators for matching dissimilar impedances. It is the purpose of this section to illustrate further analogies between electrical, mechanical and acoustical systems having similar transmission characteristics.

B. *Inductance in Shunt with a Line and the Mechanical and Acoustical Equivalents.* — In Fig. 4.5A an inductance is shunted across a line. If the impedance of the inductance is small compared to the input and output impedances, the transmission will be small. If the impedance of the inductance is large compared to the input and output impedances, the attenuation introduced by the inductance will be negligible. Since the impedance of an inductance is proportional to the frequency, the current transmission will increase with frequency as shown by the characteristic of Fig. 4.5D.

When the mass reactance in the mechanical system of Fig. 4.5B is small compared to the load impedance or driving impedance, the mass will move and there will be very little velocity (motion) transmitted to the load. If the mass reactance is comparatively large, the mass will remain stationary and the behavior will be practically the same as a directly coupled system. Since the impedance of a mass is proportional to the frequency,

the velocity transmission will increase with frequency as shown by the characteristic of Fig. 4.5D.

The acoustical system, Fig. 4.5C, consists of a pipe with a side branch forming an inductance. At low frequencies the reactance of the inductance is small compared to the impedance of the pipe and the sound is shunted out through the hole. At high frequencies the reactance of the inductance is high compared to the impedance of the pipe and the sound wave flows

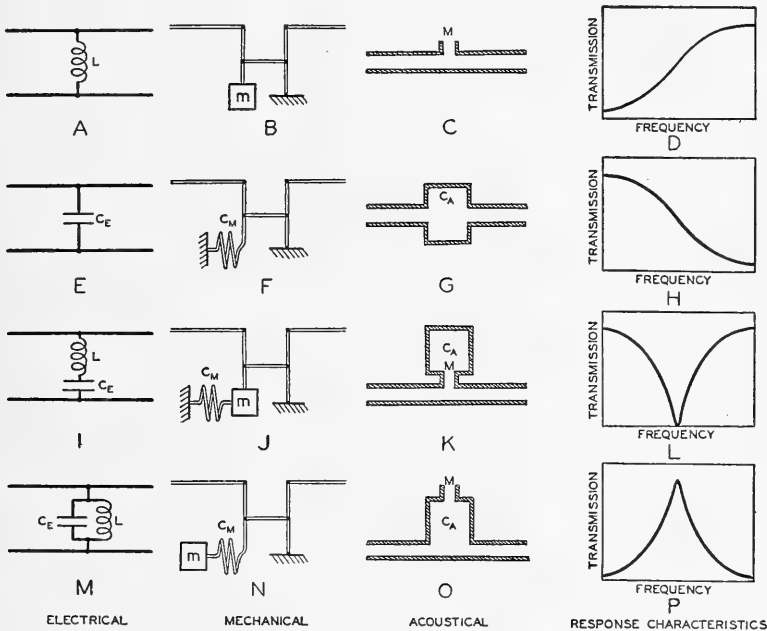

FIG. 4.5. A line shunted by the following: *A* an inductance. *E* a capacitance. *I* an inductance and a capacitance in series. *M* an inductance and a capacitance in parallel. The mechanical equivalents are shown in *B*, *F*, *J* and *N*. The acoustical equivalents are shown in *C*, *G*, *K* and *O*. The transmission-frequency characteristics are shown in *D*, *H*, *L* and *P*.

down the pipe the same as it would in the absence of a branch. Since the impedance of an inductance is proportional to the frequency, the volume current transmission will increase with frequency as shown by the characteristic of Fig. 4.5D.

*C. Capacitance in Shunt with a Line and the Mechanical and Acoustical Equivalents.* — In Fig. 4.5E a capacitance is shunted across a line. The reactance of a capacitance is inversely proportional to the frequency.

Therefore, the current transmission will decrease with increase in frequency as shown by the characteristic of Fig. 4.5H.

The reactance of the compliance of the mechanical system, Fig. 4.5F, is inversely proportional to the frequency. Therefore, at low frequencies the compliance will remain comparatively stationary and the behavior will be the same as a directly coupled system. At high frequencies the velocity (motion) of the compliance will be the same as the input velocity and there will be very little velocity transmitted to the load. The velocity transmission characteristic of this system is shown in Fig. 4.5H.

The acoustic system, Fig. 4.5G, consists of a pipe with an enlarged portion forming an acoustic capacitance. At low frequencies the reactance of the acoustic capacitance is large compared to the impedance of the pipe and the sound flows down the pipe the same as it would in the absence of the enlargement. At high frequencies the reactance of the acoustic capacitance is small compared to the impedance of the pipe and the sound is shunted out by the enlargement. Since the reactance is inversely proportional to the frequency, the volume current transmission will decrease with frequency as shown by the characteristic of Fig. 4.5H.

*D. Inductance and Capacitance in Series, in Shunt with a Line and the Mechanical and Acoustical Equivalents.* — Figure 4.5I shows an inductance and capacitance connected in series across a line. The mechanical and acoustical equivalents are shown in Figs. 4.5J and 4.5K. At low frequencies the three systems behave the same as Figs. 4.5E, 4.5F and 4.5G and there is very little attenuation. At high frequencies the systems behave the same as Figs. 4.5A, 4.5B and 4.5C and there is very little attenuation. At the resonant frequency of the inductance and the capacitance the impedance is zero. Therefore, there is no current transmission at this frequency. At the resonant frequency of the mass and compliance, Fig. 4.5J, there is no velocity transmitted because the impedance of the resonant system is zero. At the resonant frequency of the Helmholtz resonator forming the branch of the pipe line in the acoustical system of Fig. 4.5K, there is no volume current transmission because the "incident" volume current "pumps in and out" of the resonator. The transmission characteristics of the three systems of Figs. 4.5I, 4.5J and 4.5K are shown in Fig. 4.5L.

*E. Inductance and Capacitance in Parallel, in Shunt with a Line and the Mechanical and Acoustical Equivalents.* — Figure 4.5M shows an inductance and capacitance connected in parallel across a line. The mechanical and acoustical equivalents are shown in Figs. 4.5N and 4.5O. At low frequencies the systems behave the same as Figs. 4.5A, 4.5B and 4.5C and

the transmission is small. At high frequencies the systems behave the same as Figs. 4.5E, 4.5F and 4.5G and the transmission is again small. At the resonant frequency of the inductance and capacitance the impedance is infinite. Therefore, the shunt circuit introduces no attenuation at this frequency. At the resonant frequency of the mass and compliance of Fig. 4.5N the input to the spring does not move. Therefore, the system transmits the same as a directly coupled system. At the resonant frequency of the Helmholtz resonator, Fig. 4.5O, there is no volume current flowing into the resonator from the line because the input acoustic impedance is infinite. Therefore, the sound is transmitted down the pipe the same as in the absence of the resonator. The transmission characteristic of the three systems of Figs. 4.5M, 4.5N and 4.5O is shown in Fig. 4.5P.

F. *Inductance in Series with a Line and the Mechanical and Acoustical Equivalents.* — In Fig. 4.6A an inductance is connected in series with a line. If the impedance of the inductance is small compared to the input and output impedances the attenuation introduced by the inductance will be small. If the impedance of the inductance is large compared to the input and output impedances the current transmission will be small. Since the impedance of an inductance is proportional to the frequency the transmission will decrease with frequency as shown in Fig. 4.6D.

In the mechanical system of Fig. 4.6B, if the mass reactance is small compared to the load or driving impedance, the addition of the mass will cause very little reduction in the velocity transmitted to the load. If the mass reactance is comparatively large the mass will remain practically stationary and the velocity transmitted to the load will be small. Since the mechanical impedance of a mass is proportional to the frequency, the velocity transmission will decrease with frequency as shown by the characteristic of Fig. 4.6D.

The acoustical system of Fig. 4.6C consists of a pipe with a constriction which forms an inertance  $M$ . At low frequencies the reactance of the inertance is small compared to the impedance of the pipe and the inertance introduces very little attenuation. At high frequencies where the reactance of the inertance becomes large compared to the impedance of the pipe, the volume current transmission through the inertance will be small. Since the acoustic impedance of an inertance is proportional to the frequency, the volume current transmission will decrease with frequency as shown by the characteristic of Fig. 4.6D.

G. *Capacitance in Series with a Line and the Mechanical and Acoustical Equivalents.* — In Fig. 4.6E a capacitance is connected in series with a line.

The reactance of a capacitance is inversely proportional to the frequency. Therefore, the current transmission will increase with increase in frequency as shown in Fig. 4.5H.

The impedance of the compliance of the mechanical system of Fig. 4.6F is inversely proportional to the frequency. Therefore, at low frequencies the compliance will remain comparatively stationary and there will be very little velocity transmission. At high frequencies the motion of the

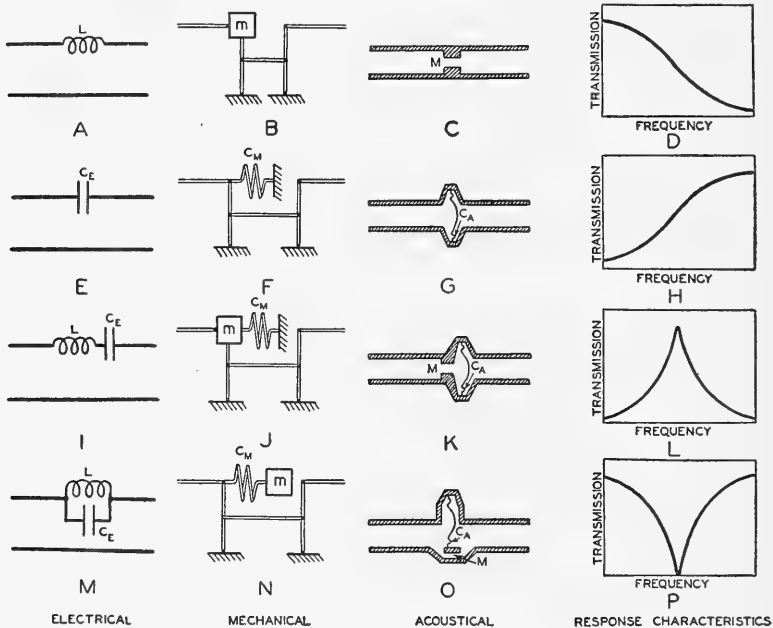

FIG. 4.6. A line in series with the following: *A* an inductance. *E* a capacitance. *I* an inductance and a capacitance in series. *M* an inductance and a capacitance in parallel. The mechanical equivalents are shown in *B*, *F*, *J* and *N*. The acoustical equivalents are shown in *C*, *G*, *K* and *O*. The transmission-frequency characteristics are shown in *D*, *H*, *L* and *P*.

compliance corresponds to the input velocity. Therefore, the velocity transmission characteristic will be shown in Fig. 4.6H.

There is no simple acoustical system which is equivalent to an electrical capacitance in series with a line. The equivalent shown in Fig. 6G consists of a stiffness controlled diaphragm, that is, the mass of the diaphragm is small and the stiffness of the suspension high so that the frequency range under consideration is well below the natural resonant frequency of the diaphragm and suspension. The acoustic capacitance of this system is

the mechanical compliance multiplied by the square of the area of the diaphragm. It will be seen that this system will not transmit a steady flow of a gas in the same way that the electrical circuit of Fig. 4.6E will not transmit direct current. Since the reactance of an acoustic capacitance is inversely proportional to the frequency, the volume current transmission will increase with increase of the frequency as shown by the characteristic of Fig. 4.6H.

H. *Inductance and Capacitance in Series, in Series with a Line and the Mechanical and Acoustical Equivalents.* — Figure 4.6I shows an inductance and capacitance connected in series in a line. The mechanical and acoustical equivalents are shown in Figs. 4.6J and 4.6K. At low frequencies the three systems behave the same as Figs. 4.6E, 4.6F and 4.6G and the transmission is small. At high frequencies the systems behave the same as Figs. 4.6A, 4.6B and 4.6C and the transmission is small. At the resonant frequency of the inductance and capacitance the impedance is zero. Therefore, the attenuation is zero at this frequency. At the resonant frequency of the mass and compliance, Fig. 4.6J, there is no attenuation because the impedance presented by the mass and compliance is zero. At the resonant frequency of the inertance and acoustic capacitance, Fig. 4.6K, the impedance of this system is zero and there is no attenuation. The transmission characteristics of the three systems of Figs. 4.6I, 4.6J and 4.6K are shown in Fig. 4.6L.

I. *Inductance and Capacitance in Parallel, in Series with a Line and the Mechanical and Acoustical Equivalents.* — Figure 4.6M shows an inductance and capacitance in parallel connected in series with a line. The mechanical and acoustical equivalents are shown in Figs. 4.6N and 4.6O. At low frequencies the systems behave the same as Figs. 4.6A, 4.6B and 4.6C and the attenuation is small. At the high frequencies the systems behave the same as Figs. 4.6E, 4.6F and 4.6G and the attenuation is small. At the resonant frequency of the inductance and capacitance, Fig. 4.6M, the impedance is infinite and there is no current transmission. At the resonant frequency of the mass and compliance of Fig. 4.6N the input to the spring does not move and there is no velocity transmission. At the resonant frequency of the inertance and acoustic capacitance the volume current "pumps" around this circuit and there is no volume current transmission. The transmission characteristics of the three systems of Figs. 4.6M, 4.6N and 4.6O are shown in Fig. 4.6L.

J. *Resistance in Series with a Line and the Mechanical and Acoustical Equivalents.* — Figure 4.7A shows a resistance in series with a line. The attenuation will be greater as the resistance is made larger. In the same

way the attenuation in the mechanical system of Fig. 4.7B will be greater as the sliding resistance is made larger. The acoustical system of Fig. 4.7C shows a pipe line with a system of slits in series with the line. The slits form an acoustic resistance. See Sec. 5.4. The attenuation in this system will increase as the acoustic resistance is made larger.

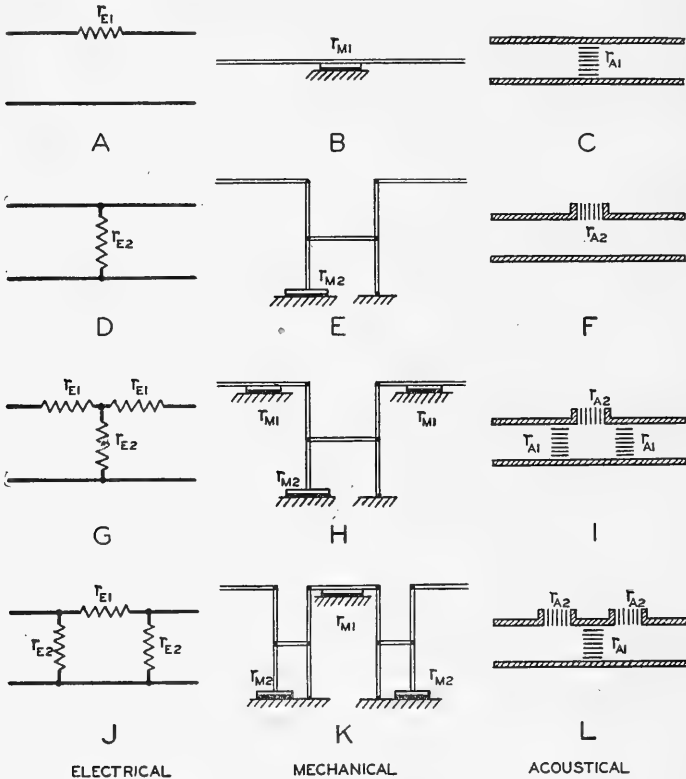

FIG. 4.7. *A*—an electrical resistance in series with a line. The mechanical and acoustical equivalents are shown in *B* and *C*. *D* an electrical resistance in shunt with a line. The mechanical and electrical equivalents are shown in *E* and *F*. A “T” and “ $\pi$ ” electrical resistance network are shown in *G* and *J*. The mechanical and acoustical equivalents are shown in *H*, *I*, *K* and *L*.

*K. Resistance in Shunt with a Line and the Mechanical and Acoustical Equivalents.*—Figure 4.7D shows a resistance in shunt with a line. The attenuation in this case will be greater as the resistance is made smaller. In the same way the attenuation in the mechanical system of Fig. 4.7E will be greater as the sliding resistance is made smaller. In the acoustical



system, Fig. 4.7F, the attenuation will increase as the shunt acoustic resistance is made smaller.

L. "T" Type Resistance Network and the Mechanical and Acoustical Equivalents. — The use of "T" resistive networks in electrical circuits for introducing attenuation without reflections or for matching two dissimilar impedances is well known. Figure 4.7G shows a "T" type electrical network and the mechanical and acoustical equivalents are shown in Figs. 4.7H and 4.7I.

M. " $\pi$ " Type Resistance Networks and the Mechanical and Acoustical Equivalents. — The " $\pi$ " type of network may be used for the same purpose as the "T" network of the preceding section. Figure 4.7J shows a " $\pi$ " type electrical network and the mechanical and acoustical equivalents are shown in Figs. 4.7K and 4.7L.

**4.10. Wave Filters.** — A. *Introduction.* — The essential function of a wave filter is to let pass desired frequency bands and to highly attenuate neighboring undesired frequency bands. Wave filters may be either electrical, mechanical or acoustical. Electric wave filters were invented by Campbell<sup>1</sup> and have innumerable uses in electrical circuits. Acoustic wave filters were invented by Stewart<sup>2</sup> and have been used extensively. Mechanical filters have been employed in all types of mechanisms for many centuries. Acoustical and mechanical wave filters are becoming very important for use in noise reduction and control of vibration in all types of machinery and appliances. It is the purpose of this section to illustrate and describe the different types of electrical, mechanical and acoustical wave filters.

B. *Types of Wave Filters.* — The response frequency characteristics of wave filters are widely different. The more frequently used types are designated as follows:

- Low Pass Wave Filters
- High Pass Wave Filters
- Band Pass Wave Filters
- Band Elimination Wave Filters

A low pass wave filter is a system which passes currents, velocities or volume currents of all frequencies from zero up to a certain frequency termed the cutoff frequency  $f_c$  and which bars currents, velocities or volume currents of all higher frequencies.

A high pass wave filter is a system which passes currents, velocities or

<sup>1</sup> Campbell, G. A., *Bell System Tech. Jour.*, Vol. 1, No. 2, 1922.

<sup>2</sup> Stewart, G. W., *Phys. Rev.*, Vol. 20, No. 6, p. 528, 1922.

volume currents of all frequencies from infinity down to a certain frequency termed the cutoff frequency  $f_c$  and which bars currents, velocities or volume currents of all lower frequencies.

A band pass filter is a system which passes currents, velocities or volume currents that lie between two cutoff frequencies  $f_{c1}$  and  $f_{c2}$  and bars currents, velocities and volume currents of all frequencies outside this range.

A band elimination filter is a system which bars currents, velocities or volume currents that lie between the two cutoff frequencies  $f_{c1}$  and  $f_{c2}$  and passes currents, velocities or volume currents of all frequencies outside this range. The transmission characteristics of low pass, high pass, band pass and band elimination filters are shown in Fig. 4.8.

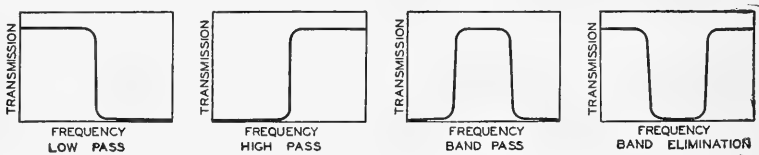

FIG. 4.8. Transmission-frequency characteristics of low pass, high pass, band pass and band elimination wave filters.

C. *Response Frequency Characteristics of Wave Filters*<sup>3,4</sup>. — The ideal or nondissipative filters must consist entirely of pure reactances. The primary object is the determination of those combinations of reactances which will give a single or double transmitted band of frequencies. The most important type of structure is the ladder type, that is, a certain combination of reactances in series with the line and another combination in shunt with the line. The series reactance and shunt reactance are designated by  $z_1$  and  $z_2$  respectively. It has been shown in treatises on wave filters that attenuation occurs when  $z_1/z_2$  is positive and if  $z_1/z_2$  is negative and is greater in absolute magnitude than four. Nonattenuation occurs when  $z_1/z_2$  is negative and is less in absolute magnitude than four. Therefore, a nondissipative recurrent structure of the ladder type having series impedances  $z_1$  and shunt impedances  $z_2$  will pass readily only currents of such frequencies as will make the ratio  $z_1/z_2$  lie between 0 and  $-4$ .

D. *Low Pass Wave Filters*. — Electrical, mechanical and acoustical low pass filters are shown in Fig. 4.9.

<sup>3</sup> Johnson, "Transmission Circuits for Telephonic Communication," p. 180, D. Van Nostrand Co., New York.

<sup>4</sup> Shea, "Transmission Networks and Wave Filters," D. Van Nostrand Co., New York.

The impedance of the series arm in the three systems is

$$z_{E1} = j\omega L \tag{4.60}$$

$$z_{M1} = j\omega m \tag{4.61}$$

$$z_{A1} = j\omega M \tag{4.62}$$

The impedance of the shunt arm in the three systems is

$$z_{E2} = \frac{1}{j\omega C_E} \tag{4.63}$$

$$z_{M2} = \frac{1}{i\omega C_M} \tag{4.64}$$

$$z_{A2} = \frac{1}{j\omega C_A} \tag{4.65}$$

The limiting frequencies are given by

$$\frac{z_1}{z_2} = 0 \quad \text{and} \quad \frac{z_1}{z_2} = -4$$

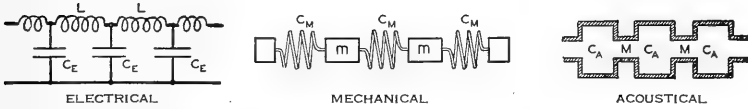

FIG. 4.9. Low pass wave filters. (Courtesy of The Blakiston Company from Olson and Massa, "Applied Acoustics.")

From the constants of the systems,

$$\frac{z_{1E}}{z_{2E}} = -LC_E\omega_c^2 = 0, \quad \text{when } \omega_c = 0 \tag{4.66}$$

$$\frac{z_{1M}}{z_{2M}} = -mC_M\omega_c^2 = 0, \quad \text{when } \omega_c = 0 \tag{4.67}$$

$$\frac{z_{1A}}{z_{2A}} = -MC_A\omega_c^2 = 0, \quad \text{when } \omega_c = 0 \tag{4.68}$$

$$\frac{z_{1E}}{z_{2E}} = -LC_E\omega_c^2 = -4, \quad \text{when } \omega_c = \frac{2}{\sqrt{LC_E}} \tag{4.69}$$

$$\frac{z_{1M}}{z_{2M}} = -mC_M\omega_c^2 = -4, \quad \text{when } \omega_c = \frac{2}{\sqrt{mC_M}} \tag{4.70}$$

$$\frac{z_{1A}}{z_{2A}} = -MC_A\omega_c^2 = -4, \quad \text{when } \omega_c = \frac{2}{\sqrt{MC_A}} \tag{4.71}$$

Equations 4.66, 4.67, 4.68, 4.69, 4.70 and 4.71 show that the systems of Fig. 4.9 are low pass filters transmitting currents, velocities or volume currents of all frequencies lying between 0 and the cutoff frequency  $f_c$  where  $f_c = \omega_c/2\pi$ .

E. *High Pass Wave Filters.* — Electrical, mechanical and acoustical high pass wave filters are shown in Fig. 4.10.

The impedance of the series arm in the three systems

$$z_{E1} = \frac{1}{j\omega C_E} \quad 4.72$$

$$z_{M1} = \frac{1}{j\omega C_M} \quad 4.73$$

$$z_{A1} = \frac{1}{j\omega C_A} \quad 4.74$$

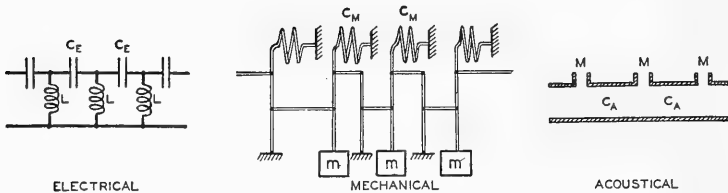

FIG. 4.10. High pass wave filters. (Courtesy of The Blakiston Company from Olson and Massa, "Applied Acoustics.")

The impedance of the shunt arm in the three systems is

$$z_{E2} = j\omega L \quad 4.75$$

$$z_{M2} = j\omega m \quad 4.76$$

$$z_{A2} = j\omega M \quad 4.77$$

The limiting frequencies are given by

$$\frac{z_1}{z_2} = 0 \quad \text{and} \quad \frac{z_1}{z_2} = -4$$

From the constants of the system,

$$\frac{z_{1E}}{z_{2E}} = -\frac{1}{LC_E\omega_c^2} = 0, \quad \text{when } \omega_c = \infty \quad 4.78$$

$$\frac{z_{1M}}{z_{2M}} = -\frac{1}{mC_M\omega_c^2} = 0, \quad \text{when } \omega_c = \infty \quad 4.79$$

$$\frac{z_{1A}}{z_{2A}} = -\frac{1}{MC_A\omega_c^2} = 0, \quad \text{when } \omega_c = \infty \quad 4.80$$

$$\frac{z_{1E}}{z_{2E}} = -\frac{1}{LC_E\omega_c^2} = -4, \quad \text{when } \omega_c = \frac{1}{2\sqrt{LC_E}} \quad 4.81$$

$$\frac{z_{1M}}{z_{2M}} = -\frac{1}{mC_M\omega_c^2} = -4, \quad \text{when } \omega_c = \frac{1}{2\sqrt{mC_M}} \quad 4.82$$

$$\frac{z_{1A}}{z_{2A}} = -\frac{1}{MC_A\omega_c^2} = -4, \quad \text{when } \omega_c = \frac{1}{2\sqrt{MC_A}} \quad 4.83$$

Equations 4.78, 4.79, 4.80, 4.81, 4.82 and 4.83 show the systems of Fig. 4.10 are high pass wave filters transmitting currents, velocities or volume currents of all frequencies lying between the cutoff frequency  $f_c$  where  $f_c = \omega_c/2\pi$ , and infinity.

F. *Band Pass Wave Filters.* — Electrical, mechanical and acoustical band pass wave filters are shown in Fig. 4.11.

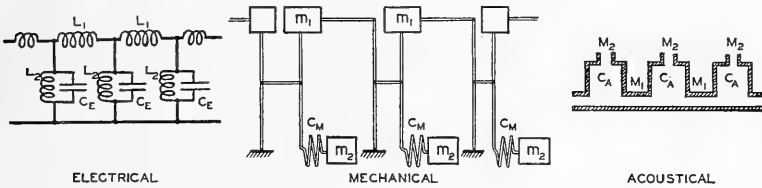

FIG. 4.11. Band pass wave filters.

The impedance of the series arm in the three systems is

$$z_{E1} = j\omega L_1 \quad 4.84$$

$$z_{M1} = j\omega m_1 \quad 4.85$$

$$z_{A1} = j\omega M_1 \quad 4.86$$

The impedance of the shunt arm in the three systems is

$$z_{E2} = \frac{j\omega L_2}{1 - \omega^2 C_E L_2} \quad 4.87$$

$$z_{M2} = \frac{j\omega m_2}{1 - \omega^2 C_M m_2} \quad 4.88$$

$$z_{A2} = \frac{j\omega M_2}{1 - \omega^2 C_A M_2} \quad 4.89$$

The limiting frequencies are given by

$$\frac{z_1}{z_2} = 0 \quad \text{and} \quad \frac{z_1}{z_2} = -4.$$

Applying these relations it can be shown that the systems of Fig. 4.11 are band pass filters transmitting currents, velocities or volume currents of all frequencies lying between two cutoff frequencies  $f_{c1}$  and  $f_{c2}$ .

G. *Band Elimination Wave Filters.* — Electrical, mechanical and acoustical band elimination wave filters are shown in Fig. 4.12.

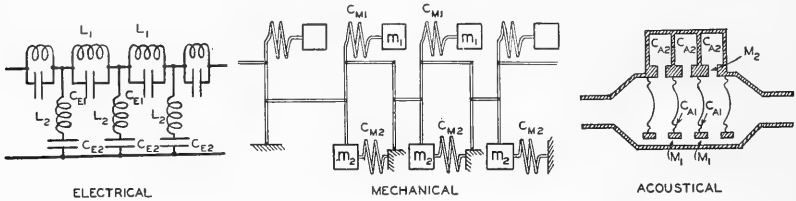

FIG. 4.12. Band elimination wave filters.

The impedance of the series arm in the three systems is

$$z_{E1} = \frac{j\omega L_1}{1 - \omega^2 C_{E1} L_1} \tag{4.90}$$

$$z_{M1} = \frac{j\omega m_1}{1 - \omega^2 C_{M1} m_1} \tag{4.91}$$

$$z_{A1} = \frac{j\omega M}{1 - \omega^2 C_{A1} M_1} \tag{4.92}$$

For a description of the acoustic capacitance  $c_{A1}$  see Sec. 4.9G

The impedance of the shunt arm in the three systems is

$$z_{E2} = j\omega L_2 - \frac{j}{\omega C_{E2}} \tag{4.93}$$

$$z_{M2} = j\omega m_2 - \frac{j}{\omega C_{M2}} \tag{4.94}$$

$$z_{A2} = j\omega M_2 - \frac{j}{\omega C_{A2}} \tag{4.95}$$

The limiting frequencies are given by

$$\frac{z_1}{z_2} = 0 \quad \text{and} \quad \frac{z_1}{z_2} = -4$$

Applying these relations it can be shown that the systems of Fig. 4.12 are band elimination filters transmitting currents, velocities or volume currents of all frequencies between zero and the cutoff frequency  $f_{c1}$  and between the cutoff frequency  $f_{c2}$  and infinity.

#### 4.11. Summary of Electrical, Mechanical and Acoustical Analogies.

— A large number of equivalent electrical, mechanical and acoustical systems have been discussed in this chapter. The analogies between the elements in the three systems are obtained by a comparison of the coefficients occurring in the differential equations of the forced oscillations in the three systems. For every symbol used in the electrical system there is a corresponding symbol in the equations for the mechanical or acoustical system. Furthermore, the corresponding symbol for each of the systems appears in exactly the same place in all the corresponding equations of the three systems. This is the essence of the electrical equivalent of a mechanical or acoustical system.

Table 4.1 lists the quantities, units, symbols and dimensions of the analogous quantities in the electrical, mechanical and acoustical systems.

Three fundamental dimensions are necessary to form a complete mechanical dimension system. Table 4.1 uses mass  $M$ , length  $L$  and time  $T$ . In the case of the electrical units dielectric constants and permeability are assumed to be dimensionless.





## CHAPTER V

### ACOUSTICAL ELEMENTS

**5.1. Introduction.** The preceding chapter is devoted to analogies between electrical, mechanical and acoustical systems. The purpose of drawing these analogies is to facilitate the solution of problems in mechanical and acoustical vibrating systems by converting these problems into the corresponding electrical equivalents and solving the resultant electrical circuits by conventional electrical circuit theory. An electrical circuit is composed of electrical elements. In the same way the acoustical system is composed of acoustical elements. The type of elements, that is, resistance, inertance or capacitance, will depend upon the characteristic manner in which the medium behaves for different sources of sound and in the different ways of confining the medium. It is the purpose of this chapter to consider acoustic elements and combination of elements.

**5.2. Acoustic Resistance.** Acoustic resistance may be obtained by forcing air through a small hole. The resistance is due to viscosity which may be considered as friction between adjacent layers of air. In the ordinary transmission of sound in a large tube the motion of all the particles in a plane normal to the axis is the same, therefore the frictional losses are small. When sound travels in a small tube the particle velocity varies from zero at the boundary to a maximum at the center. The same is true when a steady stream of air is forced through a small hole or tube, the velocity of adjacent layers varies from zero at the boundary to a maximum at the center. The smaller the hole the higher will be the resistance because of the greater effect of the sides.

A small tube also has inertance. Therefore, the reactive component increases with frequency. The mass reactance increases as the size of the hole decreases as does the resistance, but at a slower rate. Therefore, the mass reactance may be made negligible compared to the resistance if the hole is made sufficiently small.

Acoustic resistance employing viscosity may be made in various forms as, for example, a large number of small holes or a large number of slits. The acoustic impedance of fine holes and slits will be considered in the next two sections.

**5.3. Acoustic Impedance of a Tube of Small Diameter.** — The transmission of sound waves or direct currents of air in a small tube is influenced by resistance due to viscosity. The diameter is assumed to be small compared to the length so that the end correction may be neglected. The length is assumed to be small compared to the wavelength. The diameter is assumed to be small compared to the length.

The acoustic impedance of a small diameter tube <sup>1,2,3</sup> is given by

$$z_A = \frac{l}{\pi R^2} \left( \frac{8\mu}{R^2} + \frac{4}{3} j\omega\rho \right) \quad 5.1$$

where  $R$  = radius of the tube, in centimeters,

$\mu$  = viscosity coefficient,  $1.86 \times 10^{-4}$  for air

$\omega = 2\pi f$ ,  $f$  = frequency, in cycles per second,

$l$  = length of the tube, in centimeters, and

$\rho$  = density, in grams per cubic centimeter.

The effect of viscosity is to introduce resistance in the form of dissipation as well as to add to the reactance.

The resistance of a single hole is ordinarily much too high. The desired resistance may be obtained by using a sufficient number of holes.

Silk cloth provides a simple means of obtaining acoustic resistance of this type. It has been used in microphones and telephone receivers for many years. The ratio of the resistance to the reactance is governed by the size of the holes. The amount of resistance may be controlled by the number of layers and the area.

**5.4. Acoustic Impedance of a Narrow Slit.** — A narrow slit acts in a manner quite similar to the narrow tube. The length is assumed to be small compared to the wavelength. The thickness is assumed to be small compared to the length.

The acoustic impedance of a narrow slit <sup>4,5,6</sup> is given by

$$z_A = \frac{12\mu w}{d^3 l} + j \frac{6\rho w \omega}{5ld} \quad 5.2$$

where  $\mu$  = viscosity coefficient,  $1.86 \times 10^{-4}$  for air,

$\rho$  = density, in grams per cubic centimeter,

<sup>1</sup> Crandall, "Vibrating Systems and Sound," D. Van Nostrand Co., New York.

<sup>2</sup> Lamb, "Dynamical Theory of Sound," E. Arnold, London.

<sup>3</sup> Rayleigh, "Theory of Sound," Macmillan and Co., London.

<sup>4</sup> Crandall, "Vibrating Systems and Sound," D. Van Nostrand Co., New York.

<sup>5</sup> Lamb, "Dynamical Theory of Sound," E. Arnold, London.

<sup>6</sup> Rayleigh, "Theory of Sound," Macmillan and Co., London.

$d$  = thickness of the slit normal to the direction of flow, in centimeters,

$l$  = width of the slit normal to the direction of flow, in centimeters,

$w$  = length of the slit in the direction of the flow, in centimeters,

$\omega = 2\pi f$ , and

$f$  = frequency, in cycles per second.

In equation 5.2 the resistance varies inversely as the cube of  $d$  and the inertance inversely as  $d$ . Therefore, practically any ratio of inertance to resistance may be obtained. The magnitude may be obtained by a suitable choice of  $w$  and  $l$ . A slit type of resistance may be formed by using a pile of washers spaced by small shims. Another form consists of a spiral of tape with adjacent turns very close together. The former may be used as a shunt resistance in a line and the latter as a series resistance. See Sec. 4.9.

**5.5. Inertance.** — Inertance is defined as

$$M = \frac{\text{mass}}{S} \quad 5.3$$

where  $S$  = area, in square centimeters, over which the driving pressure acts to drive the mass, in grams.

The impedance of various types of systems will be considered in Secs. 5.7, 5.8 and 5.9. The imaginary part of these expressions is due to the inertance of the systems.

For closed systems the resistance term of Secs. 5.7, 5.8 and 5.9 should be omitted because there is no radiation. In this case the entire impedance is positive reactance. The reactance term of equations 5.1 and 5.2 is due to inertance.

**5.6. Acoustic Capacitance.** — The most common type of acoustic capacitance used in acoustic systems consists of a cavity or volume with rigid boundaries. The linear dimensions of the enclosure are assumed to be small compared to the wavelength.

From equation 1.21 the sound pressure is

$$p = \rho c^2 s \quad 5.4$$

where  $\rho$  = density of air,

$c$  = velocity of sound, and

$s$  = condensation.

The condensation, from Sec. 1.3D, is

$$s = \frac{dV}{V} \quad 5.5$$

where  $dV$  is the change in the original volume  $V$ .

$$dV = Sx = X \quad 5.6$$

where  $x$  = displacement, in centimeters, over the area  $S$ , in square centimeters, and

$X$  = volume displacement, in cubic centimeters.

From equations 5.4, 5.5 and 5.6

$$\frac{X}{p} = \frac{V}{\rho c^2} \quad 5.7$$

The ratio  $X/p$  is termed the acoustic capacitance by definition. See Sec. 4.4C. Therefore the acoustic capacitance of a volume is

$$C_A = \frac{V}{\rho c^2} \quad 5.8$$

The next consideration will be an acoustic capacitance combined with an acoustic resistance. The acoustic impedance of a cavity in which the boundaries or a portion of the boundary is terminated in an acoustic resistance is

$$z_A = \frac{r_A}{1 + j\omega r_A C_A} \quad 5.9$$

where  $r_A$  = acoustic resistance of the boundary,

$C_A$  = acoustic capacitance of the volume, in cubic centimeters per second,

$\omega = 2\pi f$ , and

$f$  = frequency, in cycles per second.

### 5.7. Resistive and Reactive Load upon a Vibrating Piston<sup>7, 8, 9</sup>. —

The mechanical impedance of the air load upon one side of a vibrating piston set in an infinite baffle is

$$z_M = \pi R^2 \rho c \left( 1 - \frac{J_1(2kR)}{kR} \right) + j \frac{\pi \omega \rho}{2k^3} K_1(2kR) \quad 5.10$$

where  $R$  = radius of piston, in centimeters,

$\rho$  = density, in grams per cubic centimeter,

$c$  = velocity of sound, in centimeters per second,

<sup>7</sup> Rayleigh, "Theory of Sound," Macmillan and Co., London.

<sup>8</sup> Crandall, "Vibrating Systems and Sound," D. Van Nostrand Co., New York.

<sup>9</sup> Stewart and Lindsay, "Acoustics," D. Van Nostrand Co., New York.

$k = 2\pi/\lambda$ ,  
 $\lambda =$  wavelength, in centimeters,  
 $\omega = 2\pi f$ , and  
 $f =$  frequency, in cycles per second.

$J_1$  and  $K_1$  may be found in treatises<sup>10,11</sup> on Bessel functions. They are also defined by the series,

$$1 - \frac{J_1(2kR)}{kR} = \frac{k^2 R^2}{2} - \frac{k^4 R^4}{2^2 \cdot 3} + \frac{k^6 R^6}{2^2 \cdot 3^2 \cdot 4} \cdots \quad 5.11$$

$$K_1(2kR) = \frac{2}{\pi} \left[ \frac{(2kR)^3}{3} - \frac{(2kR)^5}{3^2 \cdot 5} + \frac{(2kR)^7}{3^2 \cdot 5^2 \cdot 7} \cdots \right]$$

The acoustic impedance of the air load upon one side of a vibrating piston in an infinite baffle is

$$z_A = \frac{\rho c}{\pi R^2} \left( 1 - \frac{J_1(2kR)}{kR} \right) + \frac{j\omega\rho}{2\pi R^4 k^3} K_1(2kR) \quad 5.12$$

The impedance per unit area of the piston is

$$z_1 = \rho c \left( 1 - \frac{J_1(2kR)}{kR} \right) + \frac{j\omega\rho}{2R^2 k^3} K_1(2kR) \quad 5.13$$

The resistive and reactive components of the air load per unit area on one side of a vibrating piston set in an infinite baffle is shown in Fig. 5.1. These characteristics are useful in determining the radiation resistance and reactive component of the air load on the cone in a direct radiator loud speaker. It is also customary to use these characteristics for the impedance at the mouth of a finite horn in computing the throat impedance.

**5.8. Resistive and Reactive Load Upon a Pulsating Sphere.** — The pulsating sphere is a sphere whose radius increases and decreases with time. The motion of the air around the sphere will, like the motion of the sphere itself, take place only in radial directions and will have the same velocity in all directions, but will depend upon the distance from the center of the sphere.

The mechanical impedance of a pulsating sphere is

$$z_M = 4\pi R^2 \rho c \left( \frac{(kR)^2 + jkR}{1 + (kR)^2} \right) \quad 5.14$$

<sup>10</sup> Watson, "Theory of Bessel Functions," Cambridge Press, London.

<sup>11</sup> Jahnke and Emde, "Tables of Function," Teubner, Berlin.

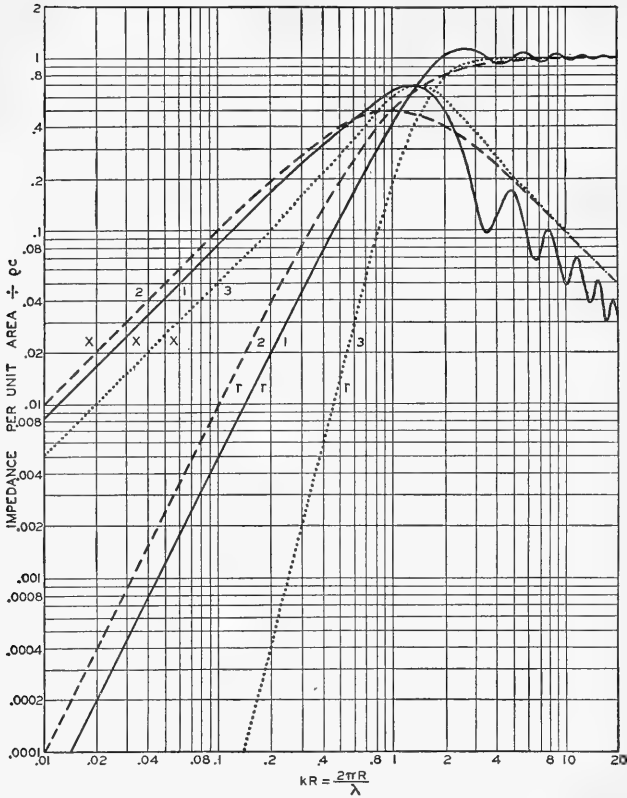

FIG. 5.1. The resistive  $r$ , and reactive  $x$ , components of the air load per unit area of the following radiators: 1. piston of radius  $R$  set in an infinite baffle; 2. a pulsating sphere of radius  $R$ ; 3. an oscillating sphere of radius  $R$ . Note: the ordinate scale of the characteristics labeled 3 must be multiplied by one-third. See Sec. 5.9.

where  $R$  = radius of the sphere, in centimeters,  
 $\rho$  = density, in grams per cubic centimeter,  
 $k = 2\pi/\lambda$ ,  
 $\lambda$  = wavelength, in centimeters, and  
 $c$  = velocity of sound, in centimeters per second.

The acoustic impedance of the air load upon a pulsating sphere is

$$z_A = \frac{\rho c}{4\pi R^2} \left( \frac{(kR)^2 + j(kR)}{1 + (kR)^2} \right) \quad 5.15$$

The impedance per unit area is

$$z_1 = \rho c \left( \frac{(kR)^2 + jkR}{1 + (kR)^2} \right) \quad 5.16$$

The resistive and reactive components upon the air load per unit area of a pulsating sphere is shown in Fig. 5.1. It will be noticed that the load upon a pulsating sphere is practically the same as that of a vibrating piston.

**5.9. Resistive and Reactive Air Load upon an Oscillating Sphere.** — An oscillating sphere is a sphere whose radius remains constant while the sphere executes a movement of translation as a function of the time. The mechanical impedance of the air load upon an oscillating sphere is

$$z_M = \frac{4\pi R^2 \rho c}{3} \left( \frac{k^4 R^4 + j(2kR + k^3 R^3)}{4 + k^4 R^4} \right) \quad 5.16A$$

where  $R$  = radius of the sphere, in centimeters,

$\rho$  = density, in grams per cubic centimeter,

$$k = \frac{2\pi}{\lambda},$$

$\lambda$  = wavelength, in centimeters, and

$c$  = velocity of sound, in centimeters per second.

The acoustic impedance of the air load upon an oscillating sphere is

$$z_A = \frac{\rho c}{12\pi R^2} \left( \frac{k^4 R^4 + j(2kR + k^3 R^3)}{4 + k^4 R^4} \right) \quad 5.16B$$

The impedance per unit area of an oscillating sphere is

$$z_1 = \frac{\rho c}{3} \left( \frac{k^4 R^4 + j(2kR + k^3 R^3)}{4 + k^4 R^4} \right) \quad 5.16C$$

The average reactive and resistive components of the air load upon an oscillating sphere is shown in Fig. 5.1. The load on an oscillating sphere is not uniform. In order to compare the radiation characteristics with those of a piston and a pulsating sphere, the ultimate resistance has been made the same. However, the average impedance per unit area of a vibrating sphere is one third that of characteristics 3 shown in Fig. 5.1.

The oscillating sphere is an acoustic doublet. See Sec. 2.3. Therefore, the resistance component is proportional to the fourth power of the frequency when the dimensions are small compared to the wavelength. The oscillating sphere represents the direct radiator loud speaker without a baffle.

**5.10. Impedance of a Circular Orifice in a Wall of Infinitesimal Thickness.** — The impedance of a circular orifice in a wall of infinitesimal thickness may be considered to be the same as that of the air load upon a piston of infinitesimal thickness and zero mass set in the opening. Then the acoustic impedance of a circular aperture in a thin wall is obtained from equation 5.12 by multiplying by 2.

**5.11. Impedance of an Open Pipe with Large Flanges.** — In this case it will be assumed: that the mouths of the pipe are fitted with freely moving massless pistons and that the length of the pipe is small compared to the wavelength. The impedance is the sum of the mass reactance of the air between the pistons and the impedance of the air load upon the pistons.

The acoustic reactance of the column of air between the two pistons, from equation 5.3, is

$$z_A = \frac{\rho l}{\pi R^2} \omega \quad 5.17$$

where  $\rho$  = density of air, in grams per cubic centimeter,  
 $l$  = length of the pipe, in centimeters,  
 $R$  = radius of the pipe, in centimeters,  
 $\omega = 2\pi f$ , and  
 $f$  = frequency, in cycles per second.

The acoustic impedance of the entire system is

$$z_A = \frac{2\rho c}{\pi R^2} \left( 1 - \frac{J_1(kR)}{kR} \right) + j \frac{\omega \rho}{\pi R^4 k^3} K_1(2kR) + \frac{j\rho l}{\pi R^2} \omega \quad 5.18$$

**5.12. Closed Pipe with a Flange.** — The impedance of a pipe closed at one end and equipped with a flange at the open end may be considered to be the sum of the impedance of the pipe and the end correction. It will be assumed that the open end of the pipe is equipped with a massless piston.

The acoustic input impedance at the piston<sup>12</sup> of the above system is

$$z_{A0} = - \frac{j\rho c}{\pi R^2} \cot kl \quad 5.19$$

where  $l$  = length of the pipe, in centimeters,  
 $R$  = radius of the pipe, in centimeters,  
 $\rho$  = density, in grams per cubic centimeter,  
 $c$  = velocity of sound, in centimeters per second,  
 $k = 2\pi/\lambda$ , and  
 $\lambda$  = wavelength, in centimeters.

<sup>12</sup> Olson and Massa, "Applied Acoustics," P. Blakiston's Son and Co., Philadelphia.



The above equation is the impedance of a closed pipe when there is no end correction as, for example, when the pipe is used in a closed system.

When the open end is free and terminated in a large baffle the total acoustic impedance is the sum of equations 5.12 and 5.19,

$$z_{AT} = \frac{2\rho c}{\pi R^2} \left( 1 - \frac{J_1(kR)}{kR} \right) + j \frac{\omega\rho}{2\pi R^4 k^3} K_1(2kR) - j \frac{\rho c}{\pi R^2} \cot kl \quad 5.20$$

The ratio of the pressure at the closed end of the tube to the free space pressure is useful in predicting the performance of pipes and cavities. The ratio of the pressure at the closed end to that in free space is

$$\left( \frac{p}{p_0} \right) = \sqrt{\left[ \cos kl - \frac{\pi R^2}{\rho c} \alpha_A \sin kl \right]^2 + \frac{(\pi R^2)^2}{(\rho c)^2} r_A^2 \sin^2 kl} \quad 5.21$$

where  $p$  = pressure at the closed end, and  
 $p_0$  = pressure in free space  $r_A$  and  $\alpha_A$  of equation 5.12.

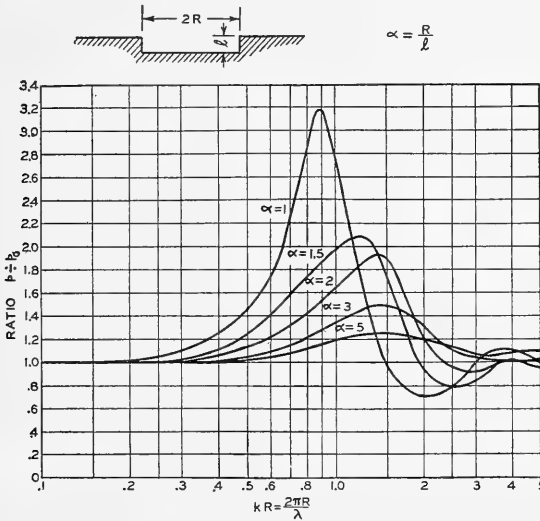

FIG. 5.2. Ratio of the pressure at the bottom of a cylindrical cavity to the free space pressure in the incident sound wave.

The characteristics of Fig. 5.2 depict the ratio of the pressure at the closed end to that in free space as a function of the dimensions of the cavity and the wavelength.

**5.13. Horns.** — A horn is an acoustic transducer consisting of a tube of varying sectional area. Horns have been widely used for centuries for

increasing the radiation from a sound source. The principal virtue of a horn resides in the possibility of presenting practically any value of acoustic impedance to the sound generator. This feature is extremely valuable for obtaining maximum overall efficiency in the design of an acoustic system. As, an example, in a horn loud speaker high efficiency is obtained by designing the system so that the driving force works against resistance instead of inertia of the diaphragm. Employing suitable combination of horns, directional characteristics which are independent of frequency, as well as practically any type of directional pattern, may be obtained. The combination of high efficiency and the possibility of any directional pattern makes the horn loud speaker particularly suitable for larger scale sound reproduction. It is the purpose of this section to consider some of the factors which influence the characteristics of a horn.

**5.14. Fundamental Horn Equation** <sup>13, 14, 15, 16, 17, 18, 19, 20</sup>. — Consider a tube with a certain rate of flare and with the diameter small compared to the wavelength of the sound passing through it. Let the axis of the tube coincide with the  $x$  axis. Take an element of volume of the tube defined as

$$S\Delta x \quad 5.22$$

where  $S$  = cross-sectional area of the tube at  $x$ , and  
 $\Delta x$  = length of the element of volume.

The growth of matter in this volume is the difference between the influx and efflux of fluid through the faces and may be expressed as

$$\Delta x \frac{\partial(S\rho'u)}{\partial x} \quad 5.23$$

where  $u$  = component of the particle velocity along the axis, and  
 $\rho'$  = density of the medium.

The principle of continuity was expressed in Sec. 1.3. Applying the principle, the difference between the influx and efflux of the fluid into the

<sup>13</sup> Webster, A. G., *Jour. Nat. Acad. Sci.*, Vol. 5, p. 275, 1919.

<sup>14</sup> Stewart, G. W., *Phys. Rev.*, Vol. 16, p. 313, 1920.

<sup>15</sup> Goldsmith and Minton, *Proc. Inst. Rad. Eng.*, Vol. 12, p. 423, 1924.

<sup>16</sup> Slepian and Hanna, *Jour. Amer. Inst. Elec. Eng.*, Vol. 43, p. 393, 1924.

<sup>17</sup> Ballantine, G., *Jour. Frank. Inst.*, Vol. 203, p. 85, 1927.

<sup>18</sup> Crandall, "Vibrating Systems and Sound," D. Van Nostrand Co., New York.

<sup>19</sup> Stewart and Lindsay, "Acoustics," D. Van Nostrand Co., New York.

<sup>20</sup> Olson and Massa, "Applied Acoustics," P. Blakiston's Son and Co., Philadelphia.

element of volume must be equal to the time rate of growth of mass.

$$\frac{\partial \rho'}{\partial t} S \Delta x = - \Delta x \frac{\partial (S \rho' u)}{\partial x} \quad 5.24$$

or

$$S \frac{\partial \rho'}{\partial t} + \frac{\partial (S \rho' u)}{\partial x} = 0 \quad 5.25$$

From equations 1.19 and 1.6

$$- \rho \ddot{\phi} = c^2 \dot{\rho}' \quad 5.26$$

From equation 1.11

$$u = \frac{\partial \phi}{\partial x} \quad 5.27$$

Substituting equations 5.26 and 5.27 in 5.25 the result may be written as

$$\ddot{\phi} - c^2 \frac{\partial \phi}{\partial x} \frac{\partial}{\partial x} (\log S) - c^2 \frac{\partial^2 \phi}{\partial x^2} = 0 \quad 5.28$$

Equation 5.28 is the wave equation for the axial motion in a tube of varying section.

**5.15. Infinite Parabolic Horn** <sup>21</sup>. — The equation expressing the cross-sectional area as a function of the distance along the axis is

$$S = S_0 x \quad 5.29$$

The general horn equation for the parabolic horn is

$$\ddot{\phi} - \frac{c^2}{x} \frac{\partial \phi}{\partial x} - c^2 \frac{\partial^2 \phi}{\partial x^2} = 0 \quad 5.30$$

The velocity potential, pressure and volume current are,

$$\phi = A [J_0(kx) - jY_0(kx)] e^{j\omega t} \quad 5.31$$

$$p = -j\omega \rho A [J_0(kx) - jY_0(kx)] e^{j\omega t} \quad 5.32$$

$$U = ASk [-J_0'(kx) + jY_0'(kx)] e^{j\omega t} \quad 5.33$$

The real and imaginary components of the acoustic impedance at the

<sup>21</sup> Olson and Wolff, *Four. Acous. Soc. Amer.*, Vol. 1, No. 3, p. 410, 1930.

throat are

$$r_A = \frac{\rho c}{S_0} \frac{2}{\pi k x_0 [J_1^2(kx_0) + Y_1^2(kx_0)]} \quad 5.34$$

$$x_A = \frac{\rho c}{S_0} \frac{J_0(kx_0)J_1(kx_0) + Y_0(kx_0)Y_1(kx_0)}{J_1^2(kx_0) + Y_1^2(kx_0)} \quad 5.35$$

where  $J_0, J_1$  = Bessel functions of the first kind of order zero and one,  
 $Y_0, Y_1$  = Bessel functions<sup>22</sup> of the second kind of order zero and one,  
 $\rho$  = density of the medium, in grams per cubic centimeter,  
 $c$  = velocity of sound, in centimeters,  
 $S_0$  = area at  $x_0$ , in square centimeters,  
 $x_0$  = distance of the throat from  $x = 0$ , in centimeters,  
 $k = 2\pi/\lambda$ , and  
 $\lambda$  = wavelength, in centimeters.

**5.16. Infinite Conical Horn.**— The equation expressing the cross-sectional area as a function of the distance along the axis is,

$$S = S_0 x^2 \quad 5.36$$

The general horn equation for the conical horn is

$$\ddot{\phi} - \frac{2c^2}{x} \frac{\partial \phi}{\partial x} - c^2 \frac{\partial^2 \phi}{\partial x^2} = 0 \quad 5.37$$

The velocity potential, pressure and volume current are

$$\phi = \frac{A}{x} e^{j(\omega t - kx)} \quad 5.38$$

$$p = - \frac{j\omega\rho A}{x} e^{j(\omega t - kx)} \quad 5.39$$

$$U = - \frac{AS(1 + jkx)e^{j(\omega t - kx)}}{x^2} \quad 5.40$$

The real and imaginary components of the acoustic impedance at the throat are

$$r_A = \frac{\rho c}{S_0} \frac{k^2 x_0^2}{1 + k^2 x_0^2} \quad 5.41$$

$$x_A = \frac{\rho c}{S_0} \frac{kx_0}{1 + k^2 x_0^2} \quad 5.42$$

<sup>22</sup> Jahnke and Emde, "Tables of Functions," Teubner, Berlin.

where  $S_0$  = area at  $x_0$ , in square centimeters,  
 $x_0$  = distance of throat from  $x = 0$ , in centimeters,  
 $k = 2\pi/\lambda$ , and  
 $\lambda$  = wavelength, in centimeters.

**5.17. Infinite Exponential Horn.** — The equation expressing the cross-sectional area as a function of the distance along the axis is

$$S = S_0 e^{mx} \quad 5.43$$

where  $S_0$  = area at the throat, that is  $x = 0$ , and  
 $m$  = flaring constant.  $\leftarrow$

The general horn equation for the exponential horn is

$$\ddot{\phi} - c^2 m \frac{\partial \phi}{\partial x} - c^2 \frac{\partial^2 \phi}{\partial x^2} = 0 \quad 5.44$$

The velocity potential, pressure and volume current are

$$\phi = e^{-(m/2)x} \left[ A e^{-j \frac{\sqrt{4k^2 - m^2}}{2} x} \right] e^{j\omega t} \quad 5.45$$

$$p = -j\omega\rho e^{-(m/2)x} \left[ A e^{-j \frac{\sqrt{4k^2 - m^2}}{2} x} \right] e^{j\omega t} \quad 5.46$$

$$U = -AS \left[ \frac{m}{2} + j \sqrt{\frac{4k^2 - m^2}{2}} \right] e^{-\frac{m}{2}x - j \frac{\sqrt{4k^2 - m^2}}{2} x + j\omega t} \quad 5.47$$

The real and imaginary components of the acoustic impedance at the throat are

$$r_A = \frac{\rho c}{S_0} \sqrt{1 - \frac{m^2}{4k^2}} \quad 5.48$$

$$x_A = \frac{\rho c}{S_0} \frac{m}{2k} \quad 5.49$$

When  $m = 2k$  or  $2\pi f = mc$  the acoustic resistance is zero. This is termed the cutoff frequency of the exponential horn.

**5.18. Throat Impedance Characteristics of Infinite Parabolic Conical and Exponential Horns.** — From the equations derived in Secs. 5.15, 5.16 and 5.17 the impedance characteristics of infinite horns may be computed. In order to compare the characteristics of the infinite parabolic, conical and exponential horns the throat area has been chosen the same for the three horns (Fig. 5.3). In addition, the area at a distance of 100 centi-

meters from the throat has been made the same for the three horns as shown in Fig. 5.3. The resistance and reactance characteristics for all three horns are shown in Fig. 5.3.

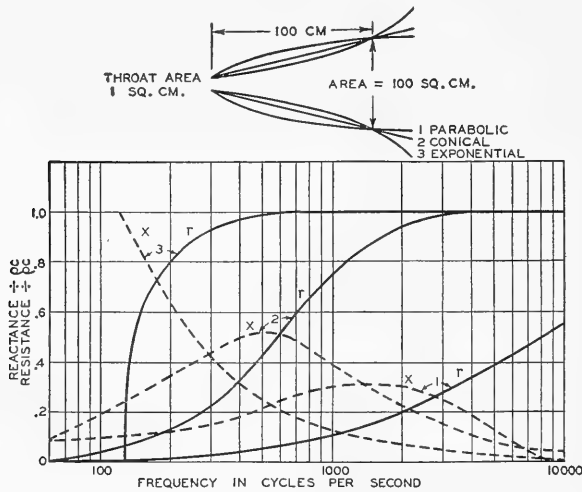

FIG. 5.3. Throat resistance  $r$ , and reactance  $x$ , of infinite parabolic, conical and exponential horns having the same throat area and the same cross section at a distance of 100 centimeters from the throat.

**5.19. Finite Conical Horn**<sup>23</sup>. — The horns most commonly used for sound reproduction are the conical and the exponential. Therefore, the consideration of finite horns will be confined to these two types.

The expression for the throat impedance of the conical horn is

$$z_{A1} = - \frac{j\rho\omega \left[ z_{A2}S_2khl \cos [k(l - h)] + (j\rho\omega hl - z_{A2}S_2h) \sin [k(l - h)] \right]}{S_1 \left[ \begin{matrix} j\rho\omega l - z_{A2}S_2(1 + k^2lh) \sin [k(l - h)] + j\rho\omega klh \\ + z_{A2}S_2k(l - h) \cos k(l - h) \end{matrix} \right]} \quad 5.50$$

- where  $S_1$  = area of the throat, in square centimeters,
- $S_2$  = area of the mouth, in square centimeters,
- $k = 2\pi/\lambda$ ,
- $\lambda$  = wavelength, in centimeters,
- $l$  = distance from the apex to the mouth, in centimeters,
- $\omega = 2\pi f$ ,
- $f$  = frequency, in cycles per second,

<sup>23</sup> Olson, H. F., *RCA Review*, Vol. 1, No. 4, p. 68, 1937.

$h$  = distance from the apex to the throat, in centimeters,  
 $\rho$  = density of air, in grams per cubic centimeter, and  
 $z_{A2}$  = acoustic impedance of the mouth, in acoustic ohms.

The impedance of the mouth of the horn is usually assumed to be the same as that of a piston in an infinite baffle. In this case the mouth impedance  $z_{A2}$  is given by equation 5.12.

The impedance characteristics of a finite conical horn is shown in Fig. 5.4.

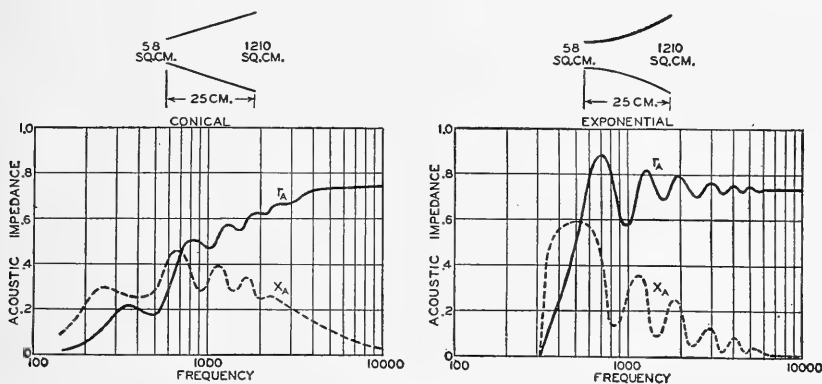

FIG. 5.4. Throat acoustic impedance characteristics of a conical and an exponential horn having the same throat and mouth area.  $r_A$ , resistive component.  $x_A$ , reactive component.

**5.20. Finite Exponential Horn**<sup>24</sup>. — The acoustic impedance at the throat of an exponential horn is

$$z_{A1} = \frac{p_1}{U_1} \quad 5.51$$

where  $p_1$  = pressure at the throat, in dynes per square centimeter, and  
 $U_1$  = volume current at the throat, in cubic centimeters per second.

The acoustic impedance at the mouth of the exponential horn is

$$z_{A2} = \frac{p_2}{U_2} \quad 5.52$$

where  $p_2$  = pressure at the mouth, in dynes per square centimeter, and  
 $U_2$  = volume current at the mouth, in cubic centimeters per second.

From equations 5.46 and 5.47 the expressions for  $p_1$ ,  $U_1$  and  $p_2$  and  $U_2$  at the points 1 and 2 corresponding to the throat and mouth may be sub-

<sup>24</sup> Olson, H. F., *RCA Review*, Vol. 1, No. 4, p. 68, 1937.

stituted in equations 5.51 and 5.52 above. The constants may be eliminated and the impedance of the throat in terms of the mouth impedance may be obtained. The final result is

$$z_{A1} = \frac{\rho c}{S_1} \left[ \frac{S_2 z_{A2} [\cos (bl - \theta)] + j \rho c [\sin (bl)]}{j S_2 z_{A2} [\sin (bl)] + \rho c [\cos (bl + \theta)]} \right] \quad 5.53$$

where  $S_1$  = area of the throat, in square centimeters,  
 $S_2$  = area of the mouth, in square centimeters,  
 $l$  = length of the horn, in centimeters,  
 $z_{A2}$  = acoustic impedance of the mouth, in acoustic ohms,  
 $\theta = \tan^{-1} a/b$ ,  
 $a = m/2$ , and  
 $b = \frac{1}{2} \sqrt{4k^2 - m^2}$ .

The impedance characteristic of a finite exponential horn is shown in Fig. 5.4. From this figure a direct comparison may be made between a conical and exponential horn of the same dimensions. These characteristics show that the exponential horn has a definite low-frequency cutoff above which the throat resistance increases rapidly and becomes a constant. On the other hand, the throat resistance of the conical horn increases slowly with frequency and shows no definite low-frequency cutoff. Furthermore, the impedance frequency characteristics of the exponential horn show a larger ratio of resistance to reactance. For these reasons the exponential horn is more desirable and accounts for its almost universal use in horn loud speakers. In view of its widespread use it is interesting to examine some of the other characteristics of exponential horns.

#### 5.21. Throat Impedance Characteristics of Finite Exponential Horns <sup>25</sup>.

— The throat acoustic impedance characteristic as a function of the mouth, with the flare and throat kept constant, is of interest in determining the optimum dimensions for a particular application. The impedance characteristics of four finite horns having a cutoff of 100 cycles, throat diameter of 1 inch and mouth diameters of 10, 20, 30 and 40 inches and the corresponding infinite horn are shown in Fig. 5.5. These results may be applied to horns of a different flare by multiplying all the dimensions by the ratio of 100 to the new cutoff frequency. The cutoff frequency of an exponential horn is given by

$$2\omega = mc \quad 5.54$$

<sup>25</sup> Olson, H. F., *RCA Review*, Vol. 1, No. 4, p. 68, 1937.



where  $\omega = 2\pi f$ ,

$f$  = frequency, in cycles per second, and

$c$  = velocity of sound, in centimeters per second.

The radiation resistance of a mouth 10 inches in diameter is relatively

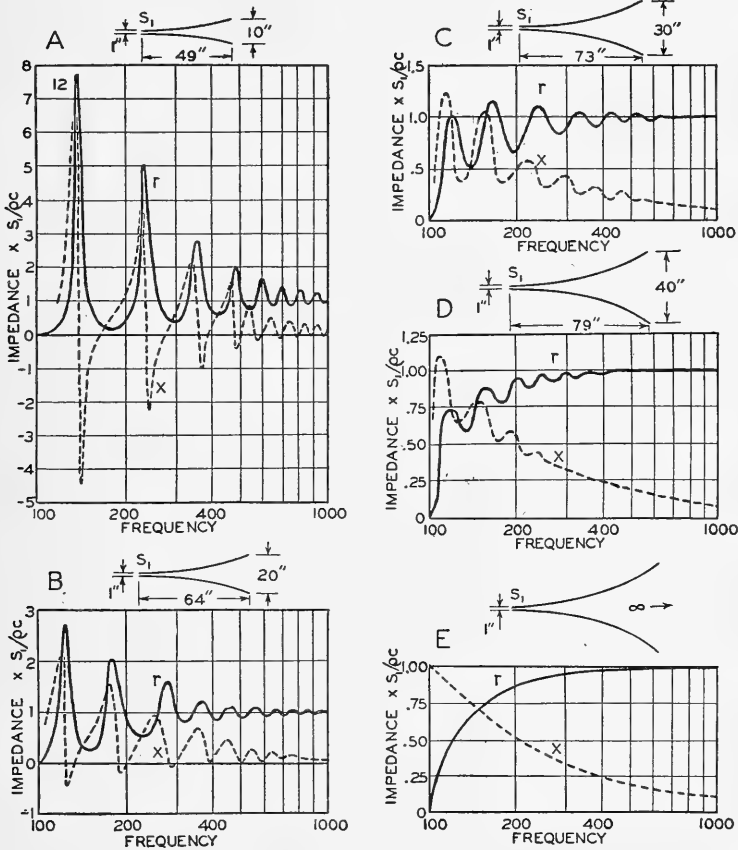

FIG. 5.5. The throat impedance characteristics of a group of exponential horns, with a flare cutoff of 100 cycles and a throat diameter of 1 inch, as a function of the mouth diameter.  $S_1$  is the area of the throat in square centimeters. Note: the characteristic shown is the throat acoustic impedance multiplied by  $S_1$  and divided by  $\rho c$ .  $r$ , resistive component.  $x$ , reactive component.

small below 500 cycles. The large change in impedance in passing from the mouth to the free atmosphere introduces reflections at the mouth and as a result wide variations in the impedance characteristic as shown in

Fig. 5.5*A*. For example, the first maximum in the resistance characteristic is 150 times the resistance of the succeeding minimum.

By doubling the diameter of the mouth the maximum variation in the resistance characteristic is 7.5, Fig. 5.5*B*.

Figure 5.5*C* shows the impedance characteristic of a horn with a mouth diameter of 30 inches. The maximum variation in the resistance characteristic of this horn is 2.

The impedance characteristic of a horn with a mouth diameter of 40 inches, Fig. 5.5*D*, shows a deviation in resistance of only a few per cent from that of the infinite horn of Fig. 5.5*E*.

These results show that as the change in impedance in passing from the mouth to the free atmosphere becomes smaller by employing a mouth diameter comparable to the wavelength, the reflection becomes correspondingly less and the variations in the impedance characteristic are reduced.

The throat acoustic impedance characteristic as a function of the throat size with the mouth and flare held constant is of interest in determining the optimum length and a suitable matching impedance for the driving mechanism. The impedance characteristics of four horns having a cutoff of 100 cycles, mouth diameter of 20 inches and throat diameter of 1, 2, 4 and 8 inches are shown in Fig. 5.6. A consideration of these characteristics shows that the throat size has no appreciable effect upon the amplitude of the variations in the impedance characteristics. However, the separation in frequency between successive maxima is increased, as the throat becomes larger, due to the decreased length of the horn. The frequency at which the first maximum in the resistance characteristic occurs becomes progressively higher as the length is decreased.

**5.22. Exponential Connectors.** — A transformer is used in electrical circuits to transfer between two impedances of different values without appreciable reflection loss. In acoustical systems a horn may be used to transfer from one impedance to another. As a matter of fact a horn may be looked upon as an acoustical transformer, transforming large pressures and small volume currents to small pressures and large volume currents. It is the purpose of this section to show how an exponential horn or connector may be used to transfer from one impedance to another.

Figure 5.7 shows an exponential horn coupled to an infinite tube. The acoustic impedance of an infinite tube is

$$\frac{\rho c}{S_2}$$

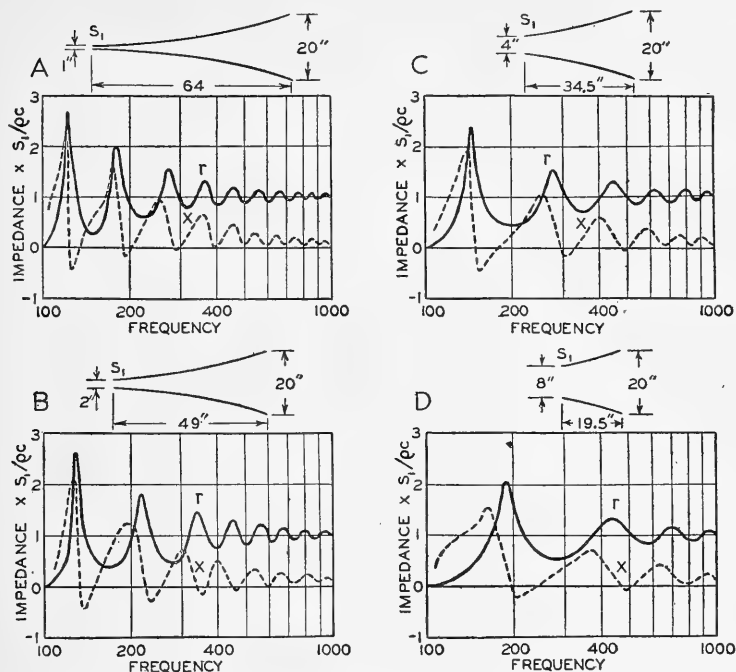

FIG. 5.6. The throat impedance characteristics of a group of exponential horns, with a flare cutoff of 100 cycles and a mouth diameter of 20 inches, as a function of the throat diameter.  $S_1$  is the area of the throat in square centimeters. Note: the characteristic shown is the throat acoustic impedance multiplied by  $S_1$  and divided by  $\rho c$ .  $r$ , resistive component.  $x$ , reactive component.

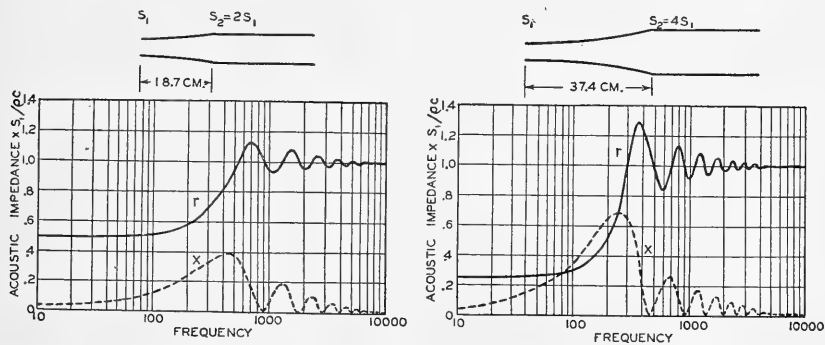

FIG. 5.7. The throat acoustic impedance characteristics of two exponential connectors with a flare cutoff of 100 cycles. The mouth of the horn is connected to an infinite pipe.  $r$ , resistive component.  $x$ , reactive component.

where  $\rho$  = density, in grams per cubic centimeter,  
 $c$  = velocity of sound, in centimeters per second, and  
 $S_2$  = cross-sectional area of the infinite tube, in square centimeters.

Equation 5.55 is the mouth impedance of the exponential horn. Equation 5.53 then becomes

$$z_{A1} = \frac{\rho c}{S_1} \left[ \frac{\cos(bl - \theta) + j \sin(bl)}{\cos(bl + \theta) + j \sin(bl)} \right] \quad 5.56$$

For  $b = 0$ , equation 5.56 is indeterminate. To evaluate take the derivative of the numerator and denominator with respect to  $b$  and set  $b = 0$ . Then the expression for the throat impedance becomes

$$z_{A1} = \frac{\rho c}{S_1} \left[ \frac{1 + j \frac{lm}{2} - \frac{lm}{2}}{1 + \frac{lm}{2} + j \frac{lm}{2}} \right] \quad 5.57$$

Below the frequency corresponding to  $b = 0$ ,  $b$  is imaginary. This portion of the range may be evaluated by employing the standard formulas involving complex quantities.

The impedance characteristics of two exponential connectors with a flare cutoff of 100 cycles (that is  $b = 0$  at 100 cycles) is shown in Fig. 5.7. Below 100 cycles the throat impedance is the same as that of the infinite pipe. However, at the high frequencies the throat impedance is the same as the surge impedance of a pipe of the diameter of the throat. In order to effect a constant transfer of impedance with respect to frequency over a certain frequency range the cutoff of the connector must be placed below the low frequency limit of the frequency range.

**5.23. A Horn Consisting of Manifold Exponential Sections**<sup>26</sup>. — The efficiency of a horn loud speaker is governed, among many other factors, by the throat resistance. To obtain the maximum efficiency at any frequency the effective reactance of the entire vibrating system should be equal to the effective resistance. This, in general, means that to obtain maximum efficiency the throat resistance of the horn should be proportional to the frequency, since the reactance is primarily mass reactance and, therefore, proportional to the frequency. Practically any throat impedance frequency characteristic may be obtained by employing a horn consisting of manifold exponential sections.

<sup>26</sup> Olson, H. F., *Four. Soc. Mot. Pic. Eng.*, Vol. 30, No. 5, p. 511, 1938.

A horn consisting of three rates of flare is shown in Fig. 5.8. The impedance characteristic at the throat of the small horn is obtained in stages. First, the throat impedance characteristic for the large horn is obtained by using equation 5.53. The throat impedance obtained for the large horn now becomes the mouth impedance of the intermediate horn. The impedance of the throat of the intermediate horn is obtained by employing

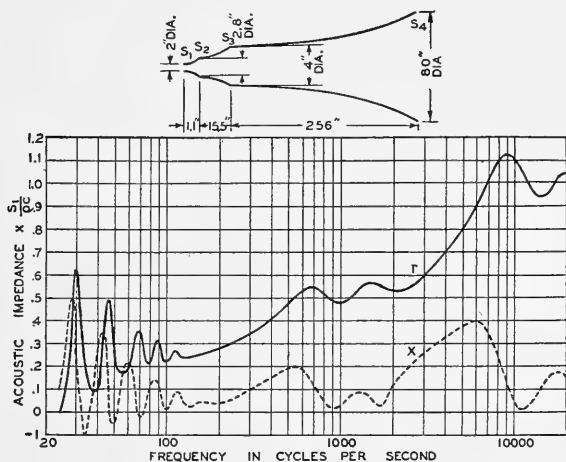

FIG. 5.8. Throat acoustic impedance characteristic of a multiple flare exponential horn of three sections. The cutoffs due to flare of the three horns are 25, 100 and 1400 cycles. In this example the impedance is referred to  $S_1$ .  $r$ , resistive component at the throat of the small horn.  $x$ , reactive component at the throat of the small horn.

equation 5.53. For the frequency corresponding to  $b = 0$  of the intermediate horn the impedance at the throat of the intermediate horn becomes indeterminate. The expression can be evaluated as shown in Sec. 5.22 on exponential connectors. Next, the throat impedance at the throat of the small horn is obtained by again employing equation 5.53. The mouth impedance of the small horn is the throat impedance just obtained for the intermediate horn. The impedance characteristic of Fig. 5.8 shows three distinct steps depicting the surge impedance of each section.

**5.24. Sound Transmission in Tubes**<sup>27, 28, 29</sup>. — The effect of viscosity upon the characteristics of small holes and slits was considered in Secs. 5.3 and 5.4. The transmission loss in tubes of circular section is of interest

<sup>27</sup> Crandall, "Vibrating Systems and Sound," D. Van Nostrand Co., New York.

<sup>28</sup> Lamb, "Theory of Sound," E. Arnold, London.

<sup>29</sup> Raleigh, "Theory of Sound," Macmillan and Co., London.

in problems in acoustics involving the use of tubes. The equation<sup>30</sup> expressing the sound transmission in a tube is

$$A = A_0 e^{-\alpha x} \quad 5.58$$

where  $A$  = amplitude (pressure or volume current) at a distance  $x$  centimeters from the amplitude  $A_0$ ,

$$\alpha = \frac{\gamma'}{Rc} \sqrt{\frac{\omega\mu}{2\rho}},$$

$R$  = radius of the tube, in centimeters,

$c$  = velocity of sound, in centimeters per second,

$$\omega = 2\pi f,$$

$f$  = frequency, in cycles per second,

$\mu$  = viscosity coefficient,  $1.86 \times 10^{-4}$  for air,

$\rho$  = density, in grams per cubic centimeters,

$\gamma' = 1 + 1.58(\gamma^{1/2} - \gamma^{-1/2})$ , and

$\gamma$  = ratio of specific heats, 1.4 for air.

The attenuation characteristics of tubes of various diameters as a function of the frequency is shown in Fig. 5.9.

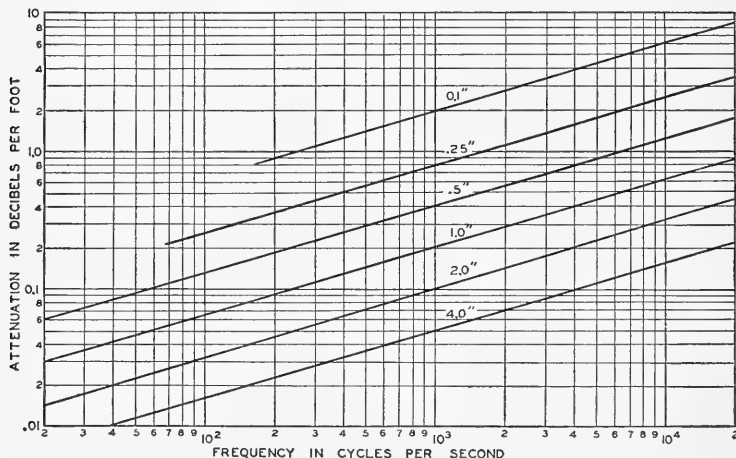

FIG. 5.9. The attenuation of a sound wave in decibels per foot as a function of the frequency in cycles per second in pipes of various diameters and filled with dry air at 20° C.

### 5.25. Transmission of Sound from one Medium to Another Medium.

— It is the purpose of this section to consider the transmission of sound energy across a junction of two media. The boundary between the two

<sup>30</sup> Mason, W. P., *Phys. Rev.*, Vol. 31, No. 2, p. 283, 1928.

media is assumed to be plane and parallel to the wave front which is also assumed to be plane.

The boundary conditions are

1. Continuity of pressure,
2. Continuity of volume current.

These conditions may be written

$$p_1 + p_1' = p_2 \quad 5.59$$

where  $p_1$  = incident pressure in the first medium, in dynes per square centimeter,

$p_1'$  = reflected pressure in the first medium, in dynes per square centimeter, and

$p_2$  = transmitted pressure in the second medium.

$$(U_1 - U_1') = U_2 \quad 5.60$$

where  $U_1$  = incident volume current in the first medium, in cubic centimeters per second,

$U_1'$  = reflected volume current in the first medium, in cubic centimeters per second, and

$U_2$  = transmitted volume current in the second medium, in cubic centimeters per second.

The acoustic impedance of the first medium is

$$r_{A1} = \frac{p_1}{U_1} \quad 5.61$$

The acoustic impedance of the second medium is

$$r_{A2} = \frac{p_2}{U_2} \quad 5.62$$

where  $r_{A1}$  = acoustic resistance of the first medium, acoustic ohms,

$r_{A2}$  = acoustic resistance of the second medium, acoustic ohms.

The incident power is

$$P_1 = \frac{p_1^2}{r_{A1}} \quad 5.63$$

The transmitted power is

$$P_2 = \frac{p_2^2}{r_{A2}} \quad 5.64$$

The ratio of the transmitted power to the incident power is from equations 5.59, 5.60, 5.61, 5.62, 5.63 and 5.64.

$$P_{12} = \frac{4r_{A1}r_{A2}}{(r_{A1} + r_{A2})^2} \quad 5.65$$

The above formula may be used to compute the acoustic resistance of materials from the absorption coefficient for materials which do not exhibit a reactive component.

The above formulas are also applicable to the sound transmitted across the junction of two semi-infinite pipes having acoustic impedances  $r_{A1}$  and  $r_{A2}$ .

**5.26. Tubes Lined with Absorbing Material.** — In ventilator and exhaust systems it is desirable to provide a high degree of attenuation for audio frequency waves while offering low resistance to continuous flow. For that purpose one of the most satisfactory systems are ducts lined with absorbing material. Longitudinal isolation of the walls of the duct should be provided to prevent longitudinal transmission of sound by the walls of the duct. This can be accomplished by the use of rubber connectors at regular intervals. The walls of the duct should be rigid so that air borne sounds are not transmitted through the walls. Very high attenuation can be obtained in ducts of this type. For example, a circular duct 12 inches in diameter lined with 1-inch rockwool gives 2 db attenuation per foot over the frequency range from 80 to 250 cycles. Above 250 the attenuation rises rapidly, being 6 db per foot at 500 cycles and 20 db per foot at 1000 cycles. The effect of d.c. air flow up to 2000 feet per minute does not appreciably change the a.c. attenuation. The general subject <sup>31</sup> of tubes lined with absorbing material, with both rigid and vibratile walls, has been considered theoretically and experimentally.

---

<sup>31</sup> Sivian, L. J., *Four. Acous. Soc. Amer.*, Vol. 9, No. 2, p. 135, 1937.



# CHAPTER VI

## DRIVING SYSTEMS

**6.1. Introduction.** — An electric mechanical or electroacoustic transducer or driving system is a system for converting electrical vibrations into the corresponding mechanical or acoustical vibrations. The most common driving systems in use to-day for converting electrical variations into mechanical vibrations are the electrodynamic, the electromagnetic, the condenser and the piezoelectric. It is the purpose of this chapter to consider the electrical and mechanical characteristics of these driving systems.

**6.2. Electrodynamic Driving System.** — A moving coil or dynamic driving system is a driving system in which the mechanical forces are de-

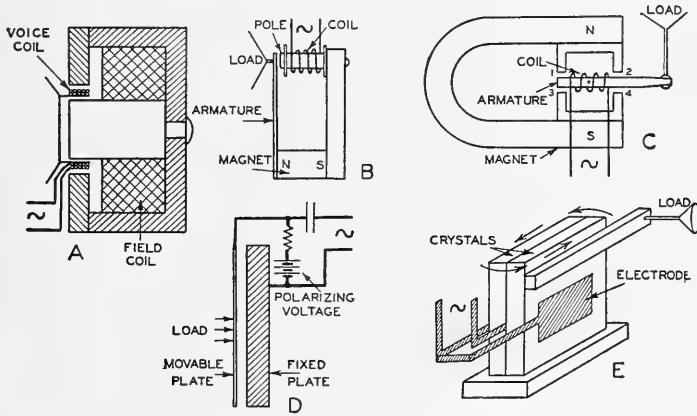

FIG. 6.1. Driving systems: *A* electrodynamic, *B* electromagnetic, reed armature, *C* electromagnetic, balanced armature, *D* condenser, *E* crystal.

veloped by the interaction of currents in a conductor and the polarizing field in which it is located (Fig. 6.1*A*). The force, in dynes, due to the interaction of the current in the voice coil and the polarizing field is

$$f_M = Bli \tag{6.1}$$

where  $B$  = flux density, in gausses,  
 $l$  = length of the conductor, in centimeters, and  
 $i$  = current, in abamperes.

The electromotive force, in abvolts, developed by the motion of the conductor is

$$e = Bl\dot{x} \quad 6.2$$

where  $\dot{x}$  = velocity, in centimeters, per second.

From equations 6.1 and 6.2

$$\frac{e}{i} = (Bl)^2 \frac{\dot{x}}{f_M} \quad 6.3$$

$$\frac{e}{i} = z_{EM} \quad 6.4$$

where  $z_{EM}$  = electrical impedance, in abohms, due to motion.

The mechanical impedance of the vibrating system is

$$\frac{f_M}{\dot{x}} = z_M \quad 6.5$$

where  $z_M$  = mechanical impedance, in mechanical ohms, the total mechanical impedance at the conductor including the mass reactance of the voice coil.

The electrical impedance due to motion (termed motional impedance) from equations 6.3, 6.4 and 6.5 is

$$z_{EM} = \frac{(Bl)^2}{z_M} \quad 6.6$$

The motional impedance of a transducer is the vector difference between its normal and blocked electrical impedance.

The normal impedance of a transducer is the electrical impedance measured at the input to the transducer when the output is connected to its normal load.

The blocked impedance of a transducer is the electrical impedance measured at the input when the mechanical system is blocked, that is, in the absence of motion.

The motional impedance may be represented as in series with the blocked impedance of the conductor.

The dynamic driving system is almost universally used for all types of direct radiator and horn types of loud speakers.

**6.3. Electromagnetic Driving System.** — A magnetic driving system is a driving system in which the mechanical forces result from magnetic reactions. There are two general types of magnetic driving systems, namely: the reed armature type and the balanced armature type.

A. *Reed Armature Type.* — A reed armature driving system consists of an electromagnet operating directly upon an armature of steel (Fig. 6.1B). The steel armature is spaced at a small distance from a pole piece wound with insulated wire carrying the alternating current and supplied with steady flux from the poles of a permanent magnet.

The flux, in maxwells, due to the permanent magnet is given by

$$\phi_1 = \frac{M}{R_1} \quad 6.7$$

where  $M$  = magnetomotive force of the magnet, in gilberts, and

$R_1$  = reluctance of the permanent field magnetic circuit, in oersteds.

The flux, in maxwells, due to the sinusoidal current  $i_{\max} \sin \omega t$  in the coils is given by

$$\phi_2 = \frac{4\pi N i_{\max} \sin \omega t}{R_2} \quad 6.8$$

where  $N$  = number of turns in the coil,

$i_{\max}$  = maximum current in the coil, in abamperes,

$R_2$  = reluctance of the alternating magnetic circuit, in oersteds,

$\omega = 2\pi f$ ,

$f$  = frequency, and

$t$  = time.

The force, in dynes, on the armature is

$$f_M = \frac{(\phi_1 + \phi_2)^2}{8\pi A} = \frac{M^2}{8\pi R_1^2 A} + \frac{MN i_{\max} \sin \omega t}{R_1 R_2 A} + \frac{\pi N^2 i_{\max}^2}{R_2^2 A} - \frac{\pi N^2 i_{\max}^2 \cos 2\omega t}{R_2^2 A} \quad 6.9$$

where  $A$  = effective area of the pole in square centimeters.

The first and third terms of the right-hand side of equation 6.9 represent a steady force, the second term represents a force of the same frequency as the alternating current and the last term represents a force of twice the frequency of the alternating current. Referring to equation 6.9 it will be seen that the driving force is proportional to the steady flux  $\phi_1$ . Also,  $\phi_1$  must be large compared to  $\phi_2$ , in order to reduce second harmonic distortion. For these reasons the polarizing flux should be made as large as possible.

The motional impedance of this system will now be considered. If all

the reluctance is assumed to reside in the air gap, the flux, in maxwells, through the armature is

$$\phi_1 = \frac{MA}{a} \quad 6.10$$

where  $M$  = magnetomotive force, in gilberts, due to the steady field,  
 $a$  = spacing between the armature and pole, in centimeters, and  
 $A$  = area of the pole, in square centimeters.

Let the armature be deflected a distance  $\Delta x$  towards the pole, the flux will now be

$$\phi_1' = \frac{MA}{a - \Delta x} \quad 6.11$$

Now, let the armature be pulled away from the normal position a distance of  $\Delta x$ , the flux will be

$$\phi_1'' = \frac{MA}{a + \Delta x} \quad 6.12$$

The difference in flux through the armature for these two conditions is

$$\Delta\phi_1 = \phi_1' - \phi_1'' = \frac{MA}{a - \Delta x} - \frac{MA}{a + \Delta x} = \frac{2MA\Delta x}{a^2 - \Delta x^2} \quad 6.13$$

This change in flux with respect to the time is

$$\frac{d\phi}{dt} = \frac{2MA}{a^2} \frac{dx}{dt} \quad 6.14$$

The electromotive force, in abvolts, generated in the coil due to this deflection of the armature is

$$e = N \frac{d\phi}{dt} = \frac{2NMA}{a^2} \dot{x} \quad 6.15$$

Leaving out the steady force and the force of twice the frequency, equation 6.9 becomes

$$f_M = \frac{MNi}{R_1 R_2 A} \quad 6.16$$

where  $i = i_{\max} \sin \omega t$ .

Combining equations 6.15 and 6.16

$$\frac{e}{i} = \frac{\dot{x}}{f_M} \frac{2M^2 N^2}{R_1 R_2 a^2} \quad 6.17$$

$$z_{EM} = \frac{2M^2 N^2}{R_1 R_2 a^2 z_{MT}} \quad 6.18$$

where  $z_{EM}$  = motional impedance, in abohms, and

$z_{MT}$  = total mechanical impedance including the armature with reference to a point on the armature directly over the pole piece.

From equations 6.7 and 6.18, assuming  $R_1 = R_2$ ,

$$z_{EM} = \frac{2\phi_1^2 N^2}{a^2 z_{MT}} \quad 6.19$$

Equation 6.19 is similar to equation 6.6 for the electrodynamic system.

This driving system is not generally used in loud speakers. The most common example of this driving system is the bipolar telephone receiver where the diaphragm is the armature.

B. *Balanced Armature Type.* — There are innumerable possibilities in the design of a magnetic driving system. The preceding section considered the simplest magnetic driving system in which both the steady flux and the alternating flux flows through the armature. It is the purpose of this section to consider the balanced armature type of driving system in which only the alternating flux flows longitudinally through the armature.

A typical balanced armature driving system is shown in Fig. 6.1C. The steady field is usually supplied by a permanent magnet. The armature is located so that it is in the equilibrium with the steady forces. The alternating current winding is wound around the armature. The steady force in dynes at 1, 2, 3 or 4, Fig. 6.1C, due to the magnetic field, is

$$f_M = \frac{\phi_1^2}{8\pi A} \quad 6.20$$

where  $\phi_1$  = total flux, in maxwells, at each pole due to the permanent magnet, and

$A$  = effective area, in square centimeters, of the pole piece at 1, 2, 3 or 4.

The flux, in maxwells, at 1, 2, 3 or 4 due to a current in the coil is

$$\phi_2 = \frac{4\pi Ni}{R_2} \quad 6.21$$

where  $N$  = number of turns in the coil,

$i$  = current in the coil, in abamperes, and

$R_2$  = reluctance of the magnetic circuit, in oersteds, which the coil energizes.

The sum of the forces, in dynes, at the points 1, 2, 3 and 4, acting upon the armature due to a current in the coil is

$$f_{MT} = \frac{2(\phi_1 + \phi_2)^2}{8\pi A} - \frac{2(\phi_1 - \phi_2)^2}{8\pi A} = \frac{\phi_1\phi_2}{\pi A} \quad 6.22$$

or

$$f_{MT} = \frac{4\phi_1 Ni}{R_2 A} \quad 6.23$$

In the case of the simple reed driving system a second harmonic term appeared in the force when a sinusoidal current was passed through the coil. It is interesting to note that in the case of the balanced armature the second harmonic term cancels out due to the push-pull arrangement.

The motional impedance of this system will now be considered. Let the armature be deflected a distance of  $\Delta x$  from the poles 2 and 3. The flux, in maxwells, through the path 1 and 4, assuming that the entire reluctance exists in the air gap, is

$$\phi_{14} = \frac{MA}{2(a - \Delta x)} \quad 6.24$$

where  $M$  = magnetomotive force, in gilberts, of the steady field,  
 $a$  = spacing between the armature and pole, in centimeters, and  
 $A$  = effective area of a pole piece, in square centimeters.

The flux through the path 2 and 3 is

$$\phi_{23} = \frac{MA}{2(a + \Delta x)} \quad 6.25$$

The flux through the armature is the difference between 6.24 and 6.25,

$$\Delta\phi = \phi_{14} - \phi_{23} = \frac{MA\Delta x}{a^2 - (\Delta x)^2} \doteq \frac{MA\Delta x}{a^2} \quad 6.26$$

The change in flux with respect to the time is

$$\frac{d\phi}{dt} = \frac{MA}{a^2} \frac{dx}{dt} = \frac{MA}{a^2} \dot{x} \quad 6.27$$

The electromotive force, in abvolts, generated in the coil is

$$e = N \frac{d\phi}{dt} = \frac{NMA}{a^2} \dot{x} \quad 6.28$$

Combining equations 6.23 and 6.28

$$\frac{e}{i} = \frac{4N^2\phi_1 M}{a^2 R_2} \frac{\dot{x}}{f_M} \quad 6.29$$

$$z_{EM} = \frac{4N^2\phi_1 M}{a^2 R_2 z_{MT}} \quad 6.30$$

where  $z_{EM}$  = motional impedance, in abohms, and

$z_{MT}$  = total mechanical impedance including the armature with reference to a point on the armature directly over one of the pole pieces.

The entire reluctance is assumed to reside in the air gap and equation 6.30 may be written,

$$z_{EM} = \frac{4N^2\phi_1^2}{a^2 z_{MT}} \quad 6.31$$

Equation 6.31 is essentially the same as equation 6.19 for the reed armature type and is similar to equation 6.6 for the electrodynamic system.

When the armature is displaced by the current, means must be provided for returning the armature to the equilibrium position. Due to the large magnetic forces, the stiffness of the centering system must be relatively large.

This driving system is used for loud speakers, galvanometers, for motion picture film recording galvanometers and for facsimile printers.

In actual practice it appears very difficult to reduce the stiffness sufficiently so that the resonance of the system will occur below 100 cycles. Therefore, when this driving system is used for a loud speaker the response will fall off quite rapidly below the resonance frequency.

**6.4. Condenser Driving System.** — A condenser driving system is a driving system in which the mechanical forces result from electrostatic reactions. Consider the system of Fig. 6.1D, consisting of a vibrating surface moving normal to its plane and separated from a fixed conductor. The force, in dynes, between the plated per unit area is

$$f_M = \frac{e^2}{8\pi x^2} \quad 6.32$$

where  $e$  = voltage between plates, in statvolts, and

$x$  = distance between the plates, in centimeters.

Assume that the polarizing voltage is  $e_0$  and that the alternating voltage

is  $e = e_{\max} \sin \omega t$ . The force, in dynes, between the plates is

$$f_M = \frac{(e_0 + e_{\max} \sin \omega t)^2}{8\pi x^2} \quad 6.33$$

$$f_M = \frac{e_0^2 + 2e_0 e_{\max} \sin \omega t + \frac{1}{2}e_{\max}^2 - \frac{1}{2}e_{\max}^2 \cos 2\omega t}{8\pi x^2} \quad 6.34$$

The first and third terms in the numerator of equation 6.34 represent steady forces. The fourth term is an alternating force of twice the frequency of the impressed voltage. The second term is an alternating force of the frequency of the impressed voltage. If the polarizing voltage  $e_0$  is large compared to the alternating voltage  $e_{\max} \sin \omega t$  the fourth term will be negligible. The useful force, in dynes, then, is the second term which causes the moving surface to vibrate with a velocity which corresponds to the impressed voltage,

$$f_M = \frac{e_0 e_{\max} \sin \omega t}{4\pi x^2} = \frac{e_0 e}{4\pi x^2} \quad 6.35$$

where  $e = e_{\max} \sin \omega t$ .

The motional impedance of this system will now be considered.

The charge, in statcoulombs, on the condenser is

$$q = C_E e_0 \quad 6.36$$

where  $e_0$  = potential difference between the plates, in statvolts, and  $C_E$  = capacity per unit area, in statfarads.

The current, in statamperes, generated due to motion is

$$i = \frac{dq}{dt} \quad 6.37$$

From equations 6.36 and 6.37 the generated current is

$$i = e_0 \frac{dC_E}{dx} \frac{dx}{dt} \quad 6.38$$

The capacity per unit area, in statfarads, is

$$C_E = \frac{1}{4\pi x} \quad 6.39$$

The change in capacity with respect to a change in the spacing  $x$  is

$$\frac{dC_E}{dx} = -\frac{1}{4\pi x^2} \quad 6.40$$



Substituting equation 6.40 in 6.38 the generated current, in statamperes, is

$$i = -\frac{e_0}{4\pi x^2} \dot{x} \quad 6.41$$

From equations 6.41 and 6.35

$$\frac{e}{i} = -\frac{16\pi^2 x^4}{e_0^2} \frac{f_M}{\dot{x}} \quad 6.42$$

$$z_{EM} = -\frac{16\pi^2 x^4}{e_0^2} z_{MT} \quad 6.43$$

where  $z_{EM}$  = motional impedance, in statohms, and

$z_{MT}$  = total mechanical impedance presented to the vibrating surface including the vibrating surface.

The condenser driving system has been employed as a loud speaker, in which case the moving electrode radiates directly into the air. Means must be provided to keep the electrodes separated without, at the same time, adding a large stiffness. In a bilateral or push-pull arrangement the movable electrode is placed between two stationary plates and the large steady forces are balanced out.

The impedance of a condenser loud speaker is inversely proportional to the frequency. This makes it very difficult to provide efficient coupling to a vacuum tube over a wide range. Another undesirable feature is the high polarizing voltage required in order to obtain high efficiency.

**6.5. Piezoelectric Driving System.** — A piezoelectric driving system is a driving system in which the mechanical forces result from the deformation of a crystal having converse piezoelectric properties. The bimorph element in use to-day is an assembly of a plurality of electroded and properly oriented plates of Rochelle salt cemented together face to face. Two types are available, namely: "benders" and "twisters." The driving system in Fig. 6.1E depicts a "twister" element. A bender element will be considered in the chapter on microphones. See Sec. 9.2C.

The deformation in centimeters at the end of the lever arm produced in a crystal by the application of an electromotive force is

$$x = K_1 e \quad 6.44$$

where  $K_1$  = constant of the crystal, and

$e$  = electromotive force, in volts.

The electric charge, in coulombs, produced by a deformation is

$$q = K_2 x \quad 6.45$$

where  $K_2$  = constant of the crystal, and

$x$  = deformation, in centimeters at the end of the lever arm.

The constants  $K_1$  and  $K_2$  depend upon the dimensions of the crystal and the temperature. It is customary to specify the open circuit voltage as a function of the twist in radians and the twist in radians for the application of, say, a 60 cycle electromotive force.

The current generated due to motion is

$$i = \frac{dq}{dt} = K_2 \dot{x} \quad 6.46$$

The force, in dynes, required to produce a given deformation is

$$f_M = x s \quad 6.47$$

where  $s$  = stiffness of the crystal, in dynes per centimeter.

From equations 6.47 and 6.44 the force, in dynes, is

$$f_M = s K_1 e \quad 6.48$$

From equations 6.46 and 6.48

$$\frac{e}{i} = \frac{1}{s K_1 K_2} \frac{f_M}{\dot{x}} \quad 6.49$$

$$z_{EM} = \frac{z_{MT}}{s K_1 K_2} \quad 6.50$$

where  $z_{EM}$  = motional impedance, in ohms, and

$z_{MT}$  = total mechanical impedance including the crystal with reference to some point of the system. In this example the reference point is at the end of the lever arm.

Equation 6.50 is similar to equation 6.43 for the condenser driving system. The capacity of crystal elements runs from .0002 to .02 mfd.

Crystal driving elements have been employed for loud speakers, telephone receivers, recording galvanometers, phonograph pickups and recording voltmeters.

## CHAPTER VII

### DIRECT RADIATOR LOUD SPEAKERS

**7.1. Introduction.** — A loud speaker is an electroacoustic transducer designed to radiate acoustic energy into a room or open air. There are two general types of loud speakers in use to-day, namely: the direct radiator and the horn type loud speaker. The diaphragm of the direct radiator loud speaker is coupled directly to the air. The diaphragm of the horn loud speaker is coupled to the air by means of a horn. The direct radiator loud speaker will be considered in this chapter and the horn loud speaker will be considered in the following chapter.

The almost universal use of the direct radiator loud speaker is due to the simplicity of construction, small space requirements, and the relatively uniform response characteristic. Uniform response over a moderate frequency band may be obtained with any simple direct radiator dynamic loud speaker. However, reproduction over a wide frequency range is restricted by practical limitations. The two extreme ends of the audio frequency band are the most difficult to reproduce with efficiency comparable to that of the mid-audio frequency range. Inefficiency at the low frequencies is primarily due to the small radiation resistance. There are a number of means available for increasing the radiation resistance at the low frequencies. A large radiation resistance may be obtained by using a large cone. A phase inverter consisting of a completely enclosed cabinet with ports provides a means for extending the low frequency range. A horn may be used for presenting a large radiation resistance to a diaphragm at the low frequencies. The efficiency of a direct radiator loud speaker at the high frequencies is limited by the mass reactance of the vibrating system. There are a number of arrangements suitable for reducing the mass of the vibrating system at the high frequencies. Two or more separate loud speaker mechanisms may be used, each designed to reproduce a certain portion of the range. Multiple cones driven by a single voice coil may be arranged so that the mass of the system decreases at the high frequencies. The voice coil may be sectionalized to decrease the mass and inductance at the high frequencies and thereby increase the high frequency range. Multiple coils and multiple cones combined into

a single mechanism may be designed to yield uniform response to the upper limit of audibility.

It is the purpose of this chapter to outline the factors which influence the performance of the conventional direct radiator loud speaker, to illustrate systems for controlling the response with respect to frequency and to describe several means for decreasing the effective mass of the vibrating systems at the high frequencies and for improving the efficiency at the low frequencies.

**7.2. Single Coil, Single Cone Loud Speaker<sup>1</sup>.** — The simple dynamic loud speaker consists of a paper cone driven by a voice coil located in a magnetic field. The mechanical impedance of this arrangement is given by

$$z_{MT} = r_{MC} + jx_{MC} + r_{MA} + jx_{MA} \quad 7.1$$

where  $r_{MC}$  = mechanical resistance in the diaphragm, in mechanical ohms,  
 $x_{MC}$  = mechanical reactance of the cone and coil, in mechanical ohms,

$r_{MA}$  = mechanical resistance due to the air load, in mechanical ohms,  
 and

$x_{MA}$  = mechanical reactance due to the air load, in mechanical ohms.

The efficiency, in per cent, of this loud speaker may be expressed as

$$\mu = \frac{(Bl)^2 r_{MA}}{(Bl)^2 (r_{MC} + r_{MA}) + r_{ED} [(r_{MC} + r_{MA})^2 + (x_{MA} + x_{MC})^2] 10^9} \times 100 \quad 7.2$$

where  $r_{ED}$  = resistance of the voice coil, in ohms,

$l$  = length of the conductor of the voice coil, in centimeters, and

$B$  = flux density in the air gap, in gaussses.

In general  $r_{MC}$  is small and may be neglected. If  $r_{MA}$  is small compared to  $x_{MA}$  and  $x_{MC}$ , equation 7.2 becomes

$$\mu = \frac{(Bl)^2 r_{MA}}{r_{ED} (x_{MA} + x_{MC})^2 10^9} \times 100 \quad 7.3$$

In terms of the resistivity and density of the voice coil the efficiency, in per cent, is

$$\mu = \frac{B^2 r_{MA} m_1}{\rho k_r (x_{MA} + x_{MC})^2 10^9} \times 100 \quad 7.4$$

<sup>1</sup> Olson, H. F., *Jour. Acous. Soc. Amer.*, Vol. 10, No. 4, p. 305, 1939.

where  $m_1$  = mass of the voice coil, in grams,  
 $\rho$  = density of the voice conductor, in grams per cubic centimeter,  
 and  
 $k_r$  = resistivity of the voice coil conductor, in ohms per cubic centimeter.

From the standpoint of maximum efficiency it is desirable to make the mass of the cone as small as possible. The maximum efficiency occurs when the mass of the coil is equal to the air load mass plus the cone mass. To fulfill this condition is not practical save at the high frequencies.

The impedance and efficiency characteristics of loud speakers with 16-inch, 4-inch, and 1-inch diameter cones are shown in Fig. 7.1. The air load resistance and reactance is assumed to be the same as that on the two sides of a vibrating piston with the diameter equal to the cone diameter. See Sec. 5.7. The weight of the cone and voice coil of the 16-inch cone are typical of loud speakers of this size in use to-day. The efficiency has been computed assuming that all parts of the cone move with the same phase. The constants of the 4-inch and 1-inch cones were chosen to yield approximately the same efficiency as the 16-inch cone. A comparison of the characteristics shows that it is possible to obtain efficiency comparable to that of the large cone over a wide range by using a small cone and coil system. Of course, the power handling capacity of the 1-inch diameter is very small at the low frequencies.

The power output, in ergs per second, of a vibrating piston is

$$P = r_{MA}\dot{x}^2 \quad 7.5$$

where  $r_{MA}$  = mechanical resistance, in mechanical ohms, from Sec. 5.7, and  
 $\dot{x}$  = rms, velocity of the piston, in centimeters per second.

Equation 7.5 may be used to compute the power output of a direct radiator loud speaker as a function of the frequency.

The peak amplitude frequency characteristics of a 16-inch, 4-inch and 1-inch piston mounted in an infinite baffle for one watt of sound output are shown in Fig. 7.2. These characteristics show that a relatively large piston is required to deliver adequate power at the lower frequencies. In addition, a relatively heavy cone is required in order to prevent generation of harmonics due to spurious vibrations of the large surfaces.

The characteristics of Fig. 7.1 show that a mass controlled system delivers constant output below the point of ultimate resistance. To deliver constant output in the range where the resistance is constant the mechanical impedance of the entire system must be independent of the frequency.

By suitable processing of the cone it is possible to reduce the mechanical impedance at the higher frequencies. In any case, there is some wave propagation in any diaphragm at the higher frequencies which in effect reduces the impedance of the vibration system.

SYSTEM	A	B	C
DIAMETER INCHES	16	4	1
MASS OF CONE	40	1	.015
MASS OF VOICE COIL GRAMS	4	.35	.015
VOICE COIL MATERIAL	COPPER	COPPER	ALUMINUM
AIR GAP FLUX GAUSSSES	10000	10000	10000

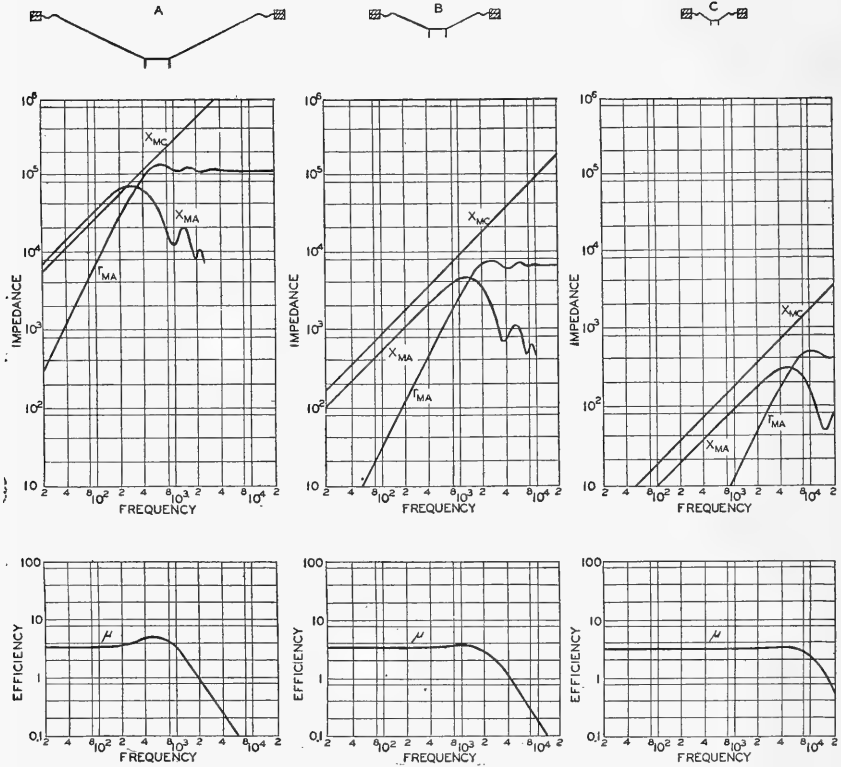

FIG. 7.1. The impedance frequency characteristics of three cone loud speakers having 1-inch, 4-inch and 16-inch diameter cones and the efficiency frequency characteristics of the three loud speakers.  $x_{MC}$  = mechanical reactance of the cone and coil,  $x_{MA}$  = mechanical reactance due to the air load,  $r_{MA}$  = mechanical resistance due to the air load and  $\mu$  = efficiency.

The performance of the systems of Fig. 7.1 was considered from the standpoint of efficiency. In certain cases it is desirable to examine the performance from a consideration of the velocities in the equivalent elec-

trical circuit of the mechanical system. In this case the driving force applied to the mechanical system must be determined.

In the example of Fig. 7.1 the damped impedance of the voice coil has been assumed to be a constant resistance. The inductance and the in-

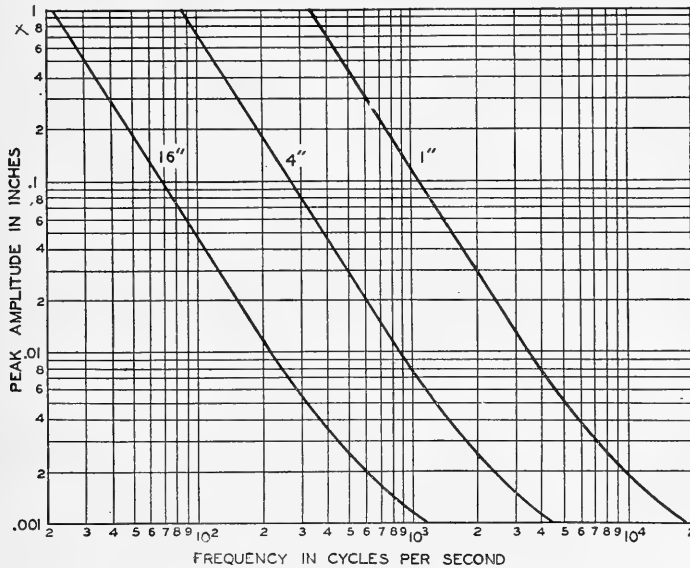

Fig. 7.2. The amplitude frequency characteristics of vibrating pistons, of various diameters mounted in an infinite wall, for one watt output on one side.

crease in resistance due to skin effect and hysteresis in the iron core at the higher frequencies causes an increase in the impedance at the higher frequencies. This, of course, reduces the force available for driving the mechanical system. The current in the electrical circuit is also influenced by the motional impedance. The motional impedance, in abohms, see Sec. 6.2, is

$$z_{EM} = \frac{(Bl)^2}{z_{MT}} \tag{7.6}$$

where  $B$  = flux density in the air gap, in gaussess,  
 $l$  = length of the conductor, in centimeters, and  
 $z_{MT}$  = total mechanical impedance, in mechanical ohms.

$$z_{MT} = r_M + j\omega m + \frac{1}{j\omega C_M} \tag{7.7}$$

where  $r_M$  = mechanical resistance, in mechanical ohms,

$m$  = mass of the air load, cone and coil, in grams, and

$C_M$  = compliance of the suspension system, in centimeters per dyne.

Due to the large mass reactance of the direct radiator loud speaker the

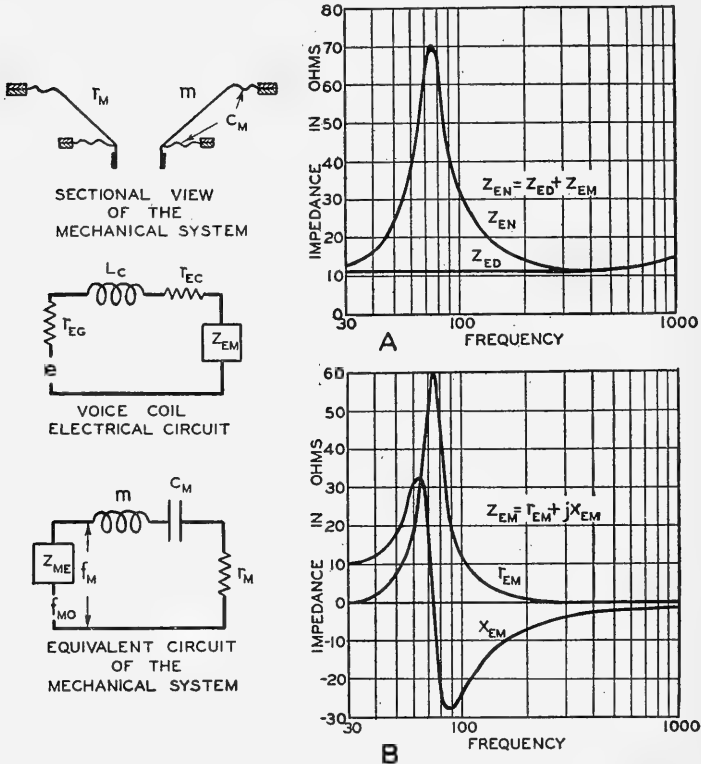

FIG. 7.3. Electrical and mechanical circuits of a dynamic loud speaker at the low frequencies. The normal impedance,  $Z_{EN}$ , and the blocked impedance,  $Z_{ED}$ , characteristics of the voice coil of a typical dynamic loud speaker are shown in graph A. The characteristics of the resistive,  $r_{EM}$ , and the reactive  $X_{EM}$ , components of the motional impedance  $Z_{EM}$  are shown in graph B.

motional impedance is very small at the high frequencies and may be neglected in calculating the driving force. However, at low frequencies it is a factor in determining the current in the voice coil circuit.

Figure 7.3 shows a cross-sectional view of a conventional direct radiator loud speaker. The fundamental resonance frequency of the loud speaker occurs at 75 cycles. The normal and damped impedance characteristic



of the voice coil is shown in Fig. 7.3*A*. The normal impedance, in abohms, of the voice coil is

$$z_{EN} = z_{EM} + z_{ED} \quad 7.8$$

where  $z_{ED}$  = impedance of the voice coil in the absence of motion, that is blocked, in abohms, and

$z_{EM}$  = motional impedance of the voice coil defined by equation 7.5, in abohms.

The components of the motional impedance are shown in Fig. 7.3*B*. At the resonant frequency the motional impedance is large because the mechanical impedance is small. The current in the voice coil circuit may be determined from the driving voltage, the resistance of the generator  $r_{EG}$ , the resistance  $r_{ED}$  and inductance  $L_c$  of the voice coil and the motional impedance  $z_{EM}$ .

The driving force, in dynes, applied to the mechanical system, see Sec. 6.2, is

$$f_M = Bli \quad 7.9$$

where  $B$  = flux density in the air gap, in gausses,

$l$  = length of the conductor, in centimeters, and

$i$  = current in the voice coil circuit, in amperes.

This is the driving force  $f_M$  applied to the mechanical system as shown in Fig. 7.3.

The mechanical impedance due to the electrical circuit, from equation 6.6, is

$$z_{ME} = \frac{Bl}{z_{EM}} \quad 7.10$$

This impedance appears in the mechanical system as shown in Fig. 7.3. In calculating the steady state performance the driving force  $f_M$  applied to the mechanical system is used and the mechanical impedance due to the electrical system need not be considered. However, in computing the transient response of the system, the damping constant, etc., the mechanical impedance due to the electrical circuit must be included. The driving force of the generator in the mechanical system which will produce a force  $f_M$  across the mechanical system is

$$f_{M0} = f_M + \frac{f_M z_{ME}}{z_{MT}} \quad 7.11$$

The increase of impedance of the voice coil, with frequency, in com-

bination with the existing vacuum tube driving system, is another factor which reduces the response of a dynamic loud speaker at the higher frequencies. The impedance characteristics of the vacuum tube power amplifiers are generally designed so that the voltage across the loud speaker, for constant voltage applied to the input of the power stage, is independent of the frequency. Therefore, the current in the voice coil decreases with frequency as the impedance increases with frequency. The impedance frequency characteristics of several voice coils are shown in Fig. 7.4. In

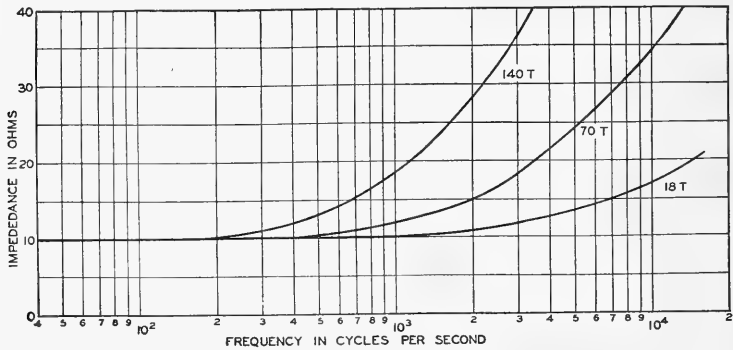

FIG. 7.4. The impedance frequency characteristics of  $1\frac{1}{2}$ -inch diameter voice coils of 140, 70 and 18 turns and all having 10 ohms d-c resistance.

the case of a large heavy voice coil the rapid increase of the impedance at the higher frequencies causes a corresponding reduction in the driving force. To maintain the driving force at the higher frequencies requires a relatively low ratio of the inductive reactance to the resistance which for a constant value of the resistance is equivalent to a reduction in the mass of the voice coil. By sectionalizing the voice coil both mechanically and electrically it is possible to reduce the mass and the electrical impedance at the higher frequencies. The constants of the single coil, single cone conventional loud speaker may be chosen to yield uniform response and adequate power handling capacity over the range from 70 to 5000 cycles. This frequency band is commonly used in moderately priced radio receivers in use to-day. Considerable improvement in the reproduction is obtained by the use of a wider frequency range. For example, wide range, radio receiver loud speakers reproduce from 50 to 8000 cycles, broadcast station monitoring loud speakers reproduce from 45 to 12,000 cycles, ultra high frequency broadcast and television-sound loud speakers reproduce from 40 to 15,000 cycles.

The above discussion, together with Figs. 7.1, 7.2, 7.3 and 7.4, shows that to obtain adequate power handling capacity and uniform response over a wide range (greater than 70 to 5000 cycles) requires a relatively large diameter and heavy diaphragm and large coil at the lower frequencies and a relatively light weight vibrating system at the higher frequencies. There are a large number of direct radiator loud speaker systems which may be built to satisfy these conditions. It is the purpose of the sections which follow to consider a number of these systems.

**7.3. Multiple Single Cone, Single Coil Loud Speaker.** — The characteristics of Fig. 7.1 show that the low frequency efficiency may be maintained to the higher frequency ranges by employing a small and relatively light cone and coil. On the other hand, to obtain adequate power handling capacity at the lower frequencies with tolerable excursions of the vibrating system requires a cone of relatively large area. To insure operation below the elastic limits of the materials a cone of large area must be of a sturdy construction. As shown in Fig. 7.1 and by equation 7.4 a large

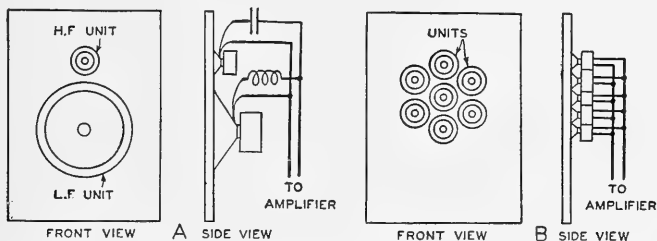

FIG. 7.5. Multiple single cone, single coil loud speakers. A. Large low frequency unit, small high frequency unit and filter system. B. Seven small units connected in parallel.

cone of this type must be driven by a relatively large coil to obtain a tolerable efficiency. The efficiency of this system is low in the high frequency range.

Adequate power handling capacity and response over a wide frequency range may be obtained by employing single coil, single cone loud speaker units in two different arrangements, as follows: First, a large diameter cone driven by a heavy coil for the reproduction of the low frequency range, a small diameter cone driven by a light coil and a filter system for allocating the power in low and high frequency ranges to the two respective low and high frequency loud speaker units, Fig. 7.5A. Second, a sufficient number of small diameter cones to satisfy the low frequency power requirements and of light construction to satisfy the high frequency response requirements, Fig. 7.5B.

In the case of the first system and referring to Figs. 7.1 and 7.2 it will be seen that uniform response and adequate power handling capacity may be obtained by employing a large and a small single coil, single cone loud speaker unit. The filter system may consist of an inductance in series with the low frequency loud speaker and a capacitance in series with the high frequency loud speaker and the two resulting circuits connected in parallel with the power amplifier. See Fig. 7.5*A*. Due to the large electrical reactance of the large voice coil of the low frequency loud speaker, see Fig. 7.4, it has been found that for most applications the inductance in series with the low frequency loud speaker may be omitted. On the other hand, if a more elaborate filter system is required the circuit of Fig. 8.18 may be used.

Referring to Sec. 7.2 and Figs. 7.1 and 7.2 it will be seen that uniform response and adequate power handling capacity may be obtained by employing a large number of small cones driven by light coils. The constants of the system may be determined from the frequency range. Then the number of units may be determined from the required power output and the allowable excursion together with equation 7.5 or Fig. 7.2. An arrangement of seven small loud speakers mounted in a flat baffle with the voice coils connected in parallel is shown in Fig. 7.5*B*. The voice coils of the loud speakers may of course be connected in parallel, series or series-parallel. In order to obtain better high frequency spatial distribution the units may be inclined at various angles, for example, the units may be mounted so that the resulting vibrating surface approximates that of a sphere.

The multiple loud speaker systems described above possess certain disadvantages. The radiating surfaces must be separated by a finite distance with the result that the system may exhibit peculiar directional characteristics in the overlap region where the sound radiation issues from both loud speakers. The same is true of the small units at the higher frequencies. The cost of two or more field structures is in general more than that of a single structure.

**7.4. Single Coil, Double Cone Loud Speaker**<sup>2</sup>.—A typical single coil, multiple cone loud speaker, Fig. 7.6*B*, consists of a single coil coupled to two cones. In this system an increase in frequency range is obtained by reducing the impedance of the diaphragm by coupling a smaller cone to the voice coil at the high frequencies. The two cones  $z_{M1}$  and  $z_{M2}$  are separated by a compliance  $C_M$ . At low frequencies the mechanical re-

---

<sup>2</sup>Olson, H. F., *Jour. Acous. Soc. Amer.*, Vol. 10, No. 4, p. 305, 1939.

actance of the compliance  $C_M$  is large compared to the mechanical impedance  $z_{M1}$  and consequently the entire system moves as a whole. At high frequencies the mechanical reactance of the compliance  $C_M$  is small compared to  $z_{M1}$  and the small cone  $z_{M2}$  moves while  $z_{M1}$  remains stationary. By means of this reduction in cone mechanical impedance the range may be extended almost a full octave, depending upon the mass and electrical impedance characteristics of the voice coil. The response characteristics of a single coil, single cone loud speaker is shown in Fig. 7.6A. The voice coil and large cone of Fig. 7.6B combination is the same as that of Fig. 7.6A. The high frequency range has been extended about one-half octave without any sacrifice of power handling capacity.

**7.5. Double Coil, Single Cone Loud Speaker**<sup>3</sup>. — The double coil single cone loud speaker, Fig. 7.6C, consists of a voice coil, divided into two parts separated by a compliance, coupled to a single corrugated cone. The larger portion of the voice coil  $L_1, r_{E1}$  is shunted by a capacitance  $C_E$ . At low frequencies the reactance of the capacitance is large compared to the impedance of the larger portion of the voice coil  $L_1, r_{E1}$  and the mechanical reactance of the compliance  $C_M$  separating the two portions of the voice coil is large compared to the mechanical mass reactance of  $m_1$  and the mechanical impedance  $z_{M1}$ . Therefore, in the low frequency range the action is the same as that of a single coil loud speaker. At high frequencies the reactance of the capacitance  $C_E$  is small compared to the impedance  $L_1, r_{E1}$  or  $L_2, r_{E2}$  and the mechanical reactance of the compliance  $C_M$  is small compared to the mechanical reactance of  $m_1$ . The cone is driven by the lighter portion  $m_2$  of the voice coil and the heavy coil  $m_1$  remains stationary. In the mid range there is a phase difference between the currents in the two portions of the voice coil. A corresponding phase shift occurs in the mechanical system. As a consequence, a smooth overlap is obtained in going from two coil operation at the low frequencies to a single coil operation at the high frequencies. Above the frequency of ultimate resistance the radiation resistance is a constant. In order to obtain uniform output in this range the impedance of the system must be independent of the frequency. This may be accomplished by embossing suitable corrugations in the cone which reduce the effective mass reactance. The double coil system reduces the effective mass reactance of the voice coil as compared to a single coil, as well as the electrical impedance at the higher frequencies. A typical response characteristic of this loud speaker is shown in Fig. 7.6C.

<sup>3</sup> Olson, H. F., *Proc. Inst. Rad. Eng.*, Vol. 22, No. 1, p. 33, 1934.

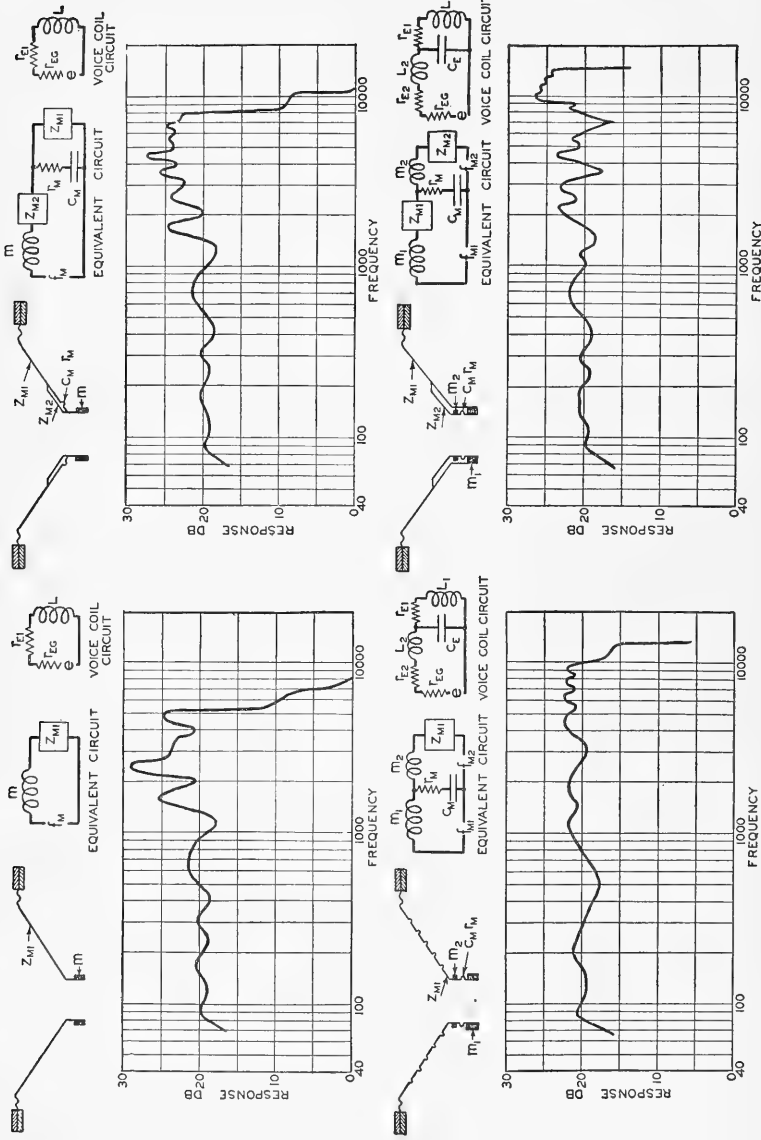

FIG. 7.6. A. Upper Left-Hand. Cross-sectional view of a single cone, single coil loud speaker with the voice coil circuit diagram and the equivalent circuit of the mechanical system. In the voice coil circuit:  $e$  the internal voltage of the generator.  $r_{EG}$  the internal resistance of the generator.  $r_{E1}$  and  $L$  the resistance and the inductance of the voice coil. In the equivalent circuit:  $m$  the mass of the voice coil,

$z_{M1}$  the mechanical impedance of the cone at the voice coil.  $f_M$  the force generated in the voice coil. The graph shows the pressure response frequency characteristic.

*B. Upper Right-Hand.* Cross-sectional view of a double cone, single coil loud speaker with the voice coil circuit diagram and equivalent circuit of the mechanical system. In the voice coil circuit:  $e$  the internal voltage of the generator.  $r_{EG}$  the internal resistance of the generator.  $r_{E1}$  and  $L_1$  the resistance and inductance of the voice coil. In the equivalent circuit:  $m$  the mass of the voice coil.  $z_{M1}$  and  $z_{M2}$  the mechanical impedance of the large and small cones.  $C_M$  and  $r_M$  the compliance and mechanical resistance of the corrugation in the large cone.  $f_M$  the force generated in the voice coil. The graph shows the pressure response frequency characteristic.

*C. Lower Left-Hand.* Cross-sectional view of a single coil, double coil loud speaker with the voice coil circuit and the equivalent circuit of the mechanical system. In the voice coil circuit:  $e$  the internal voltage of the generator.  $r_{EG}$  the internal resistance of the generator.  $r_{E1}$  and  $L_1$  the resistance and the inductance of the large coil.  $r_{E2}$  and  $L_2$  the resistance and inductance of the small coil.  $C_E$  the capacitance shunting the large coil. In the equivalent circuit:  $m_1$  the mass of the large coil.  $m_2$  the mass of the small coil.  $z_{M1}$  the mechanical impedance of the cone at the voice coil.  $C_M$  and  $r_M$  the compliance and resistance of the corrugation separating the large coil and small coils.  $f_{M1}$ ,  $f_{M2}$  the force generated in the large coil.  $f_M$  the force generated in the small coil. The graph shows the pressure response frequency characteristic.

*D. Lower Right-Hand.* Cross-sectional view of a double cone, double coil loud speaker with the voice coil circuit and equivalent circuit of the mechanical system. In the voice coil circuit:  $e$  the internal voltage of the generator.  $r_{EG}$  the internal resistance of the generator.  $r_{E1}$  and  $L_1$  the resistance and the inductance of the large coil.  $r_{E2}$  and  $L_2$  the resistance and the inductance of the small coil.  $C_E$  the capacitance shunting the large coil. In the equivalent circuit:  $m_1$  the mass of the large coil.  $m_2$  the mass of the small coil.  $z_{M1}$  the mechanical impedance of the large cone.  $z_{M2}$  the mechanical impedance of the small cone.  $C_M$  and  $r_M$  the compliance of the corrugation separating the large cone and coil and the small cone and coil.  $f_{M1}$  the force generated in the large coil.  $f_{M2}$  the force generated in the small coil. The graph shows the pressure response frequency characteristic.

## 7.6. Double Coil, Double Cone Loud Speaker<sup>4</sup>. —

The double coil, double cone loud speaker, Fig. 7.6D, consists of a light coil coupled to a small cone, connected by a compliance to a heavy coil and large cone. In this system an increase in range is obtained by reducing the impedance of both the coil and the diaphragm at the higher frequencies. At low frequencies the electrical reactance of the capacitance  $C_E$  is large compared to the electrical impedance of the large portion of the voice coil  $L_1$ ,  $r_{E1}$  and the same current flows in both coils. The mechanical reactance of the compliance  $C_M$  separating the two portions of the coil is large compared to the mechanical impedance of  $m_1$ . Therefore, at low frequencies the system behaves as a single coil, single cone loud speaker. Both parts of the voice coil are used at low frequencies; no air gap flux is wasted as would be the case if two separate units were used. At high frequencies the electrical capa-

<sup>4</sup> Olson, H. F., *Jour. Acous. Soc. Amer.*, Vol. 10, No. 4, p. 305, 1939.

citance  $C_E$  is small compared to the impedance of either the heavy coil  $L_2$ ,  $r_{E2}$  or the light coil  $L_1$ ,  $r_{E1}$  and practically all the current flows in the light coil. The mechanical impedance of the compliance  $C_M$  is small compared to the mechanical reactance of  $m_1$  or the mechanical impedance of  $z_{M1}$ . Therefore, at high frequencies the small cone  $z_{M2}$  is driven by the light coil  $m_2$  and the heavy coil  $m_1$  and the large cone  $z_{M1}$  remain stationary. This system is equivalent to two separate loud speakers. The advantage, of course, resides in the fact that only a single field structure of the size required to accommodate a coil the size of the two coils is needed. Such a field structure coil system and large cone would be required to give equivalent performance at the low frequencies. The response frequency characteristic of a double cone, double coil loud speaker is shown in Fig. 7.6D. This system provides a means of obtaining good response to 14,000 cycles. At the same time, the diameter of the large cone can be chosen so that moderate power handling capacity as a direct radiator loud speaker may be obtained at the low frequencies.

The directional characteristics of a vibrating piston are given in Sec. 2.7. These characteristics show that if the effective diameter of the cone decreases inversely with respect to the frequency, the directional characteristics will be independent of the frequency. The effective diameter of practically all direct radiator loud speakers decreases at the higher frequencies. The effect can be accentuated by corrugating the cone as shown in Fig. 7.6C. A very close approximation to uniform directional characteristics may be obtained in the double cone loud speaker by a suitable selection of cone diameters.

**7.7. Mechanical Networks for Controlling the High Frequency Response of a Loud Speaker.** — In general, in radio and other forms of sound reproduction it is desirable to attenuate the response above a certain high frequency limit. In some cases, it may be desirable to attenuate a certain band as, for example, 10,000 cycles in radio reproduction to eliminate the adjacent channel beat note. Electrical networks and filters are usually quite costly compared to mechanical filters for certain applications in sound reproduction. It is the purpose of this section to describe the construction and performance of several mechanical networks and filters for suppressing certain frequency bands or for attenuating the high frequency response of a loud speaker.

A relatively light weight, 8-inch loud speaker was chosen for these tests. This type of loud speaker is used in small radio receivers. Due to the small mass of the cone and coil the response is well maintained at the high frequencies. The principles involved are applicable to all loud speakers.



The loud speaker was mounted in a 3-foot irregular baffle. The response was obtained employing a velocity microphone located on the axis of the speaker at a distance of two feet.

A. *Conventional Single Coil Loud Speaker.* — The response frequency characteristic of the conventional loud speaker, referred to above, is shown in Fig. 7.7A. The equivalent electrical circuit of the mechanical system is also shown in Fig. 7.7A. The constants have been indicated as the mass of the voice coil  $m_1$ , the compliance of the centering suspension, the cone impedance including the cone outside suspension and the radiation resistance, etc., lumped as  $z_{MC}$ . The response is well maintained to 12,000 cycles. For this reason, this loud speaker is well adapted to illustrate the performance of mechanical networks for controlling the response at the higher frequencies.

B. *Loud Speaker with a Compliance Shunting the Cone Impedance.* — One of the simplest means for attenuating the high frequency response of a loud speaker is a compliance inserted between the voice coil and the cone. This compliance  $C_M$  may take the simple form of a bead or corrugation pressed into the voice coil form. The response characteristic of a conventional loud speaker with a compliance between the voice coil and cone is shown in Fig. 7.7B. In the equivalent electrical circuit the compliance  $C_M$  shunts the cone impedance  $z_{MC}$ . Comparing with Fig. 7.7A it will be seen that there is some attenuation at the higher frequencies. However, the attenuation is not large. This is due to the fact that the impedance  $z_{MC}$  does not increase appreciably with frequency. At the higher frequencies a light cone, in particular, does not vibrate as a piston. In a large diameter light cone the action changes gradually from piston action to wave propagation at the higher frequencies. As a consequence, the impedance does not increase directly with the frequency. In some loud speakers  $z_{MC}$  actually decreases with frequency at the higher frequencies.

C. *Loud Speaker with a Compliance Shunting; a Compliance and Mass in Parallel, Connected in Series with Cone Impedance.* — In a radio receiver it is desirable to attenuate the response at 10,000 cycles so that the 10,000 cycle adjacent channel beat note will not be reproduced. A parallel circuit inserted in series with a line causes high attenuation at the resonance frequency. See Sec. 4.9. By inserting a parallel circuit in series with the voice coil and cone the response will be reduced at the resonance frequency. The amount of attenuation will depend upon the magnitude of the resistance in the compliance. An example of this system is shown in Fig. 7.7C. The compliance and mass are  $m_2$  and  $C_{M2}$ . Comparing with Fig. 7.7A the attenuation at 10,000 cycles is about 25 db. This system is also easy to

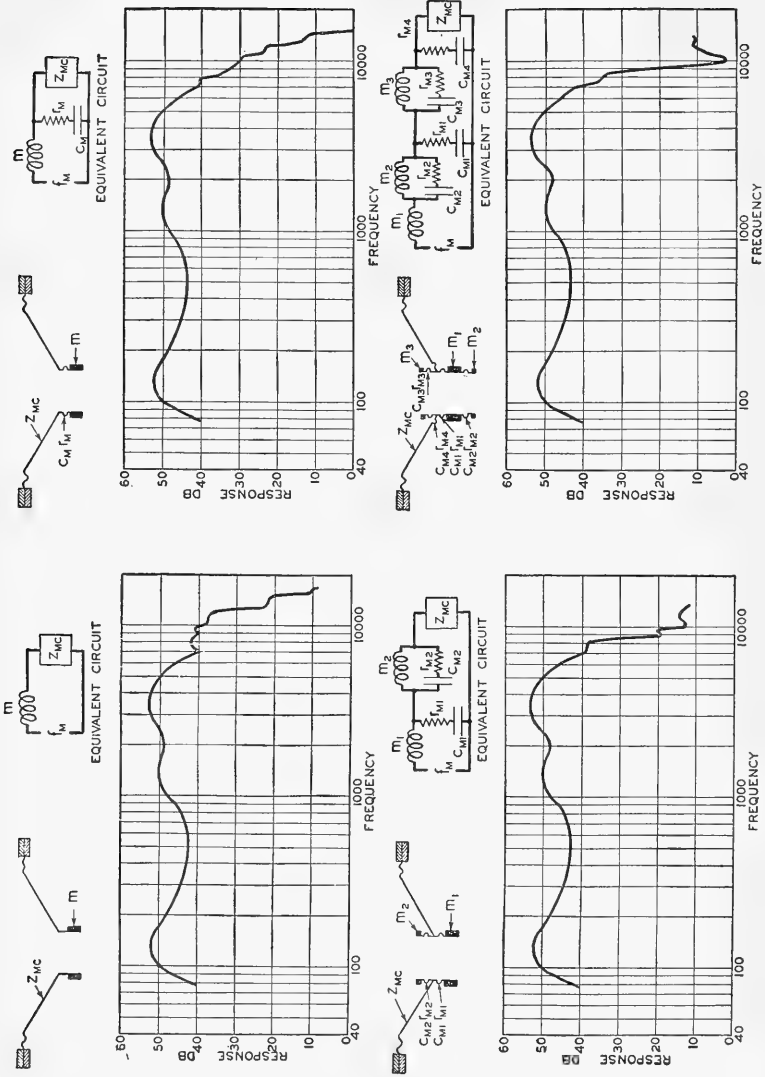

FIG. 7.7. A. Upper Left-Hand. Cross-sectional view of a conventional single coil loud speaker and the equivalent electrical circuit of the mechanical system. In the equivalent circuit:  $m$  the mass of the voice coil,  $Z_{MC}$  the mechanical impedance of the cone and suspension system. The graph shows the pressure response frequency characteristic.

*B. Upper Right-Hand.* Cross-sectional view of the loud speaker in *A* with a corrugation, rolled into the voice coil form, separating the coil and cone. In the equivalent circuit:  $m$  the mass of the coil.  $C_M$  and  $r_M$  the compliance and mechanical resistance of the corrugation separating the coil and the cone.  $z_{MG}$  the mechanical impedance of the cone and suspension system. The graph shows the pressure response frequency characteristic.

*C. Lower Left-Hand.* Cross-sectional view of the loud speaker in *B* with a mass connected by a corrugation to the front of the cone. In the equivalent circuit:  $m_1$  the mass of the voice coil.  $C_{M1}$  and  $r_{M1}$  the compliance and mechanical resistance of the corrugation separating the coil and the cone.  $C_{M2}$  and  $r_{M2}$  the compliance of the corrugation connecting the mass  $m_2$  to the cone.  $z_{MG}$  the mechanical impedance of the cone. The graph shows the pressure response frequency characteristic.

*D. Lower Right-Hand.* Cross-sectional view of the loud speaker in *C* with a mass connected by a corrugation to the bottom end of the voice coil. In the equivalent circuit:  $m_1$  the mass of the voice coil.  $C_{M1}$  and  $r_{M1}$  the compliance and mechanical resistance of the corrugation separating the coil and the cone.  $C_{M2}$  and  $r_{M2}$  the compliance and mechanical resistance of the corrugation connecting the mass  $m_2$  to the cone.  $C_{M3}$  and  $r_{M3}$  the compliance and mechanical resistance of the corrugation connecting the mass  $m_3$  to the cone.  $C_{M4}$  and  $r_{M4}$  the compliance and mechanical resistance of the corrugation in the cone.  $z_{MG}$  the mechanical impedance of the cone. The graph shows the pressure response frequency characteristic.

fabricate. Two suitable corrugations are pressed into a single voice coil form.

*D. Loud Speaker with a "T" Type Filter Connecting the Voice Coil Mass and the Cone Impedance.* — This system, Fig. 7.7D, consists of two parallel resonant circuits, or a parallel resonant circuit  $m_2$  and  $C_{M2}$  connected to the bottom of the voice coil of the system of Fig. 7.7C. The equivalent electrical circuit is also shown in Fig. 7.7D. The system then is a "T" type low pass filter connecting the coil and cone. See Sec. 4.10. Very high attenuation is obtained at the resonance frequency of the arms. The response frequency characteristic of this system is shown in Fig. 7.7D. Comparing with Fig. 7.7A the attenuation at 10,000 cycles is 35 db. The attenuation is also quite high above 10,000 cycles. As in the other systems it is made by simply pressing three corrugations into a single voice coil form.

Several mechanical networks for controlling and suppressing the response of a loud speaker at the high frequencies have been described. The cost of the system is very small compared to an electrical circuit for accomplishing the same result because the networks are made by simply placing corrugations in the voice coil form. These examples also illustrate the value of equivalent electrical circuits in designing and in predicting the action of mechanical systems.

**7.8. Loud Speaker Baffles.** — A baffle is a partition which may be used with an acoustic radiator to increase the effective length of the acoustic transmission path between the front and back of the radiator. The term baffle is commonly applied to a plane surface. When a direct radiator

loud speaker is mounted in a baffle, there exists a  $180^\circ$  phase difference between the front and back of the cone. When the baffle is small compared to the wavelength the system is an acoustic doublet. See Sec. 2.3. In this frequency range the power output for constant velocity is proportional to the fourth power of the frequency. When the baffle is large compared to the wavelength, the two sides of the cone act independently and the power output is proportional to the square of the frequency. See Sec. 2.2. In the case of a mass controlled system the velocity is inversely

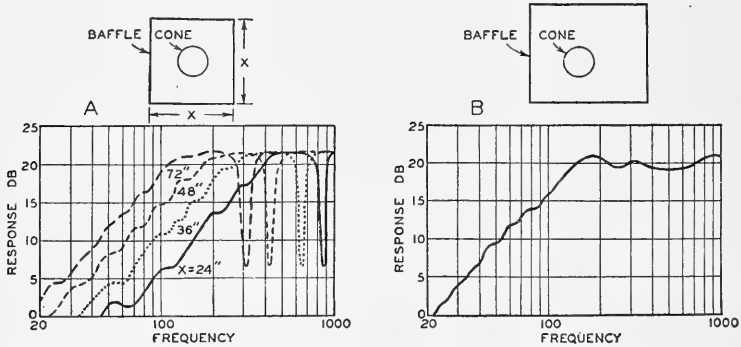

FIG. 7.8. *A.* Pressure response frequency characteristics of a mass controlled direct radiator dynamic loud speaker mounted in 2-, 3-, 4- and 6-foot square baffles. *B.* Response frequency characteristic of a mass controlled direct radiator dynamic loud speaker mounted in an irregular baffle.

proportional to the frequency. Therefore, in the case of the large baffle the output will be independent of frequency. See Sec. 7.2. However, when the dimensions of the baffle are small compared to the wavelength, the power output in the case of a mass controlled system is proportional to the square of the frequency. In this range the low frequency response falls off rapidly. The response characteristics of a mass controlled cone loud speaker mounted in various sizes of square baffles are shown in Fig. 7.8*A*. The transition between doublet operation and independent operation is quite marked. This transition point occurs when the dimensions of the baffle are slightly less than one half wavelength. Above the transition frequency the response is practically independent of the frequency. Below this frequency the response falls off about 6 db per octave.

In the case of a cone in a square baffle the path from the front to the back is practically the same for all possible paths. Therefore, some peculiarities in the response would be expected when the acoustic path from the front to back is equal to a wavelength. At this frequency the sound

that is diffracted around the baffle and transmitted forward will interfere destructively with the radiation from the front. The response characteristics of Fig. 7.8*A* show "dips" in the response when the acoustic path from front to back is a wavelength. Using an irregular baffle, Fig. 7.8*B*, it is possible to reduce this interference and obtain a uniform response characteristic. In this baffle the various paths from front to back differ and the destructive interference is spread over a wide frequency range. The response characteristics of an irregular baffle, Fig. 7.8*B*, show that the dip in the response characteristic of the square baffle is eliminated by the use of an irregular baffle.

As pointed out in the early part of this chapter, low efficiency at the high frequencies is primarily the result of the inherent mass reactance of the vibrating system. Inefficiency at the low frequencies is primarily due to a small radiation resistance. The large flat baffle is not suitable for commercial sound reproduction in which appearance is a factor. Therefore, most commercial sound reproducers are housed in some form of cabinet which may be styled to conform with the surroundings. These cabinets and other acoustic networks associated with the loud speaker are designed to yield the maximum efficiency at the low frequencies. It is the purpose of the sections which follow to describe some of the means for improving the response of a direct radiator loud speaker at the low frequencies.

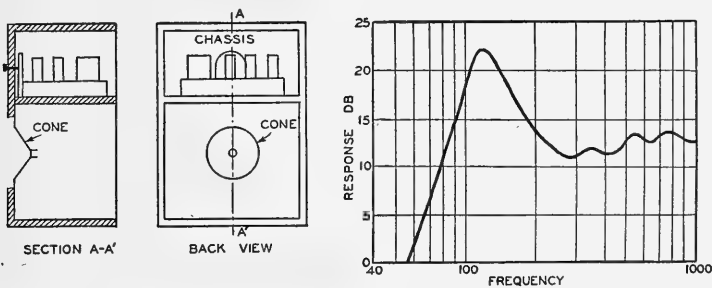

FIG. 7.9. A direct radiator loud speaker mounted in a typical radio receiver cabinet. The graph shows the pressure response frequency characteristic of this system.

**7.9. Cabinet Reproducers.**—The most common housing for a direct radiator loud speaker is the conventional open back cabinet which also houses the radio chassis or phonograph mechanism (Fig. 7.9). These range in size from the largest console type to the smallest midget. From the standpoint of sound reproduction the principle is the same in all,

namely: to provide a baffle for the loud speaker. In the case of the midget cabinets the sound path from the front to the back is very small and the low frequency sounds are not reproduced. In the case of the large console cabinets the acoustic path length is sufficiently large to insure good reproduction of low frequencies. One of the most troublesome acoustical factors in conventional cabinets is the resonance in the enclosure back of the cone. This resonance is termed cabinet resonance. The system may be considered from the standpoint of lumped or distributed constants. In the case of most systems, the latter viewpoint seems to yield better agreement with experiment. The cabinet enclosing the back of the cone may be considered to be a pipe with distributed constants. The termination at the back may be considered to be the same as that of a piston. The first resonance occurs when the velocity at the back is high and the pressure at the cone is high. At this frequency the efficiency of the entire system is relatively high and the response is accentuated. The response characteristic on a typical console cabinet is shown in Fig. 7.9. It will be seen that the response is accentuated in the range between 100 and 200 cycles. In order to maintain the response below 100 cycles the fundamental resonance of the cone and its suspension system is usually placed somewhere in the neighborhood of 80 cycles. It will be seen that satisfactory response is maintained down to 70 cycles. The accentuation of the response due to cabinet resonance is most noticeable on speech in the accentuation of low frequency response which reduces the articulation and destroys the naturalness.

It is possible to reduce the response in the region of cabinet resonance by means of electrical compensation in the amplifier feeding the loud speaker.

Helmholtz resonators tuned to the frequency of cabinet resonance may be placed within the cabinet at the point of high pressure. The Helmholtz resonator shunts the cabinet network and, therefore, reduces the response at the resonant frequency. See Sec. 4.9.

For wide range reproduction acoustical networks are incorporated in the cabinet to improve the coupling between the cone and the air at the low frequencies. It is the purpose of the sections which follow to describe some of these systems.

**7.10. Back Enclosed Cabinet Loud Speaker.** — A reproducer with the back of the cabinet completely enclosed is shown in Fig. 7.10. At the low frequencies the system is a simple source. See Sec. 2.2. The output will be independent of the frequency if the system is mass controlled, that is, if the velocity of the cone is inversely proportional to the frequency. This

condition is fulfilled above the resonance frequency of the system. Below the resonance frequency the output falls off rapidly with frequency. A consideration of the equivalent circuit shows that the fundamental resonance of the system is influenced by both the acoustic capacitance of the suspension system and the acoustic capacitance of the cabinet volume. The response frequency characteristic with and without the back on the

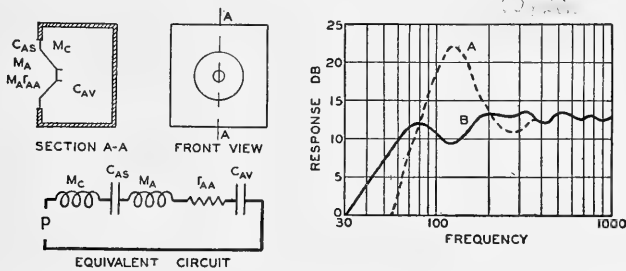

FIG. 7.10. Back enclosed loud speaker and the equivalent circuit of the acoustical system.  $M_C$  the inductance of the cone.  $C_{AS}$  the acoustic capacitance of the suspension system.  $M_A$  and  $r_{AA}$  the inductance and acoustic resistance of the air load upon the front of the cone.  $C_{AV}$  the acoustic capacitance of the cabinet volume. The pressure  $p$  of the generator in the acoustic system is the force generated in the voice coil divided by the area of the cone. The pressure response frequency characteristic of the back enclosed cabinet is labeled  $B$  on the graph. The pressure response frequency characteristic with the back removed is labeled  $A$  on the graph.

cabinet is shown by the graph of Fig. 7.10. It will be seen that the response with the back enclosed cabinet is superior to the conventional open back cabinet. This is in general the case, providing the fundamental resonance frequency of the cone is made sufficiently low. The low frequency response of the open back cabinet falls off more rapidly with decrease in the frequency than that of the closed cabinet. This is due to the fact that the open back cabinet acts as a doublet while the closed back cabinet acts as a simple source. See Secs. 2.2 and 2.3. The power output of a doublet for constant velocity is proportional to the fourth power of the frequency while the power output of a simple source is proportional to the square of the frequency. As a consequence, the power output of a back enclosed cabinet will be independent of the frequency above the fundamental resonance frequency of the system.

**7.11. Acoustic Phase Inverter**<sup>5</sup>. — The acoustic phase inverter consists of a direct radiator loud speaker mechanism mounted in a back enclosed cabinet with a pipe coupling the cabinet volume to the air (Fig. 7.11).

<sup>5</sup> Dickey, Caulton and Perry, *Radio Engineering*, Vol. 8, No. 2, p. 104, 1936.

The equivalent circuit of this system is also shown in Fig. 7.11. The phase of the volume currents on the front and back of the cone differs by  $180^\circ$ . Referring to the equivalent circuit of Fig. 7.11, the volume currents in the branches 1 and 2 of the equivalent circuit may differ by as much as  $180^\circ$  for the case of positive reactances with no resistance in branches 1 and 2, and a pure capacitance for the branch 3. The phase will be reduced

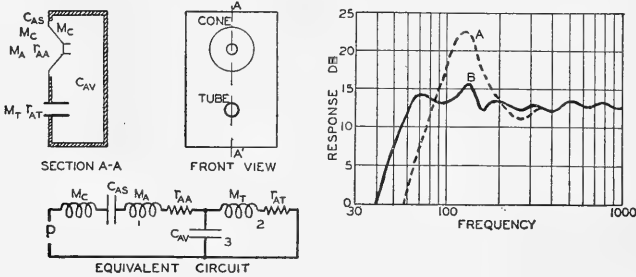

FIG. 7.11. Phase inverter loud speaker and the equivalent circuit of the acoustical system.  $M_C$  the inductance of the cone.  $C_{AS}$  the acoustic capacitance of the suspension system.  $M_A$  and  $r_{AA}$  the inductance and the resistance of the air load upon the front of the cone.  $C_{AV}$  the acoustic capacitance of the cabinet volume.  $M_T$  and  $r_{AT}$  the inductance and acoustic radiation resistance of the tube. The pressure  $p$  of the generator in the acoustical system is the force generated in the voice coil divided by the area of the cone. The pressure response frequency characteristic of the phase inverter loud speaker is labeled *B* on the graph. The pressure response frequency characteristic of a loud speaker in a typical cabinet having the same volume as the phase inverter is labeled *A* on the graph. (After Dickey, Caulton and Perry.) (Courtesy of The Blakiston Company from Olson and Massa, "Applied Acoustics.")

when resistance is introduced. However, the resistance in direct radiator systems is low compared to the reactances in the system and the constants may be chosen so that the volume currents issuing from the front of the cone and the tube are practically in phase. This system increases the radiation resistance and decreases the reactance of a direct radiator loud speaker at the low frequencies. The response frequency characteristic of the acoustic phase inverter, as compared to the response obtained on the same loud speaker mounted in a cabinet with the back open, is shown in Fig. 7.11. The low frequency range is extended, cabinet resonance is eliminated and a smoother response characteristic is obtained.

**7.12. Acoustical Labyrinth Loud Speaker**<sup>6</sup>. — The acoustical labyrinth loud speaker consists of an absorbent walled conduit with one end tightly coupled to the back of the cone of a direct loud speaker mechanism and the

<sup>6</sup> Olney, Benj., *Four. Acous. Soc. Amer.*, Vol. 8, No. 2, p. 104, 1936.



other end opening in front or at the bottom of the cabinet within which it is folded (Fig. 7.12). The labyrinth is a piston driven tube with absorbing walls. At the first half wavelength resonance the velocity at the open end is in phase with that at the front of the cone. The radiation, then, from both sources is additive and the response is increased. An increase in response can be obtained over about an octave. The rising absorption of the tube lining with increase in frequency damps out the higher reso-

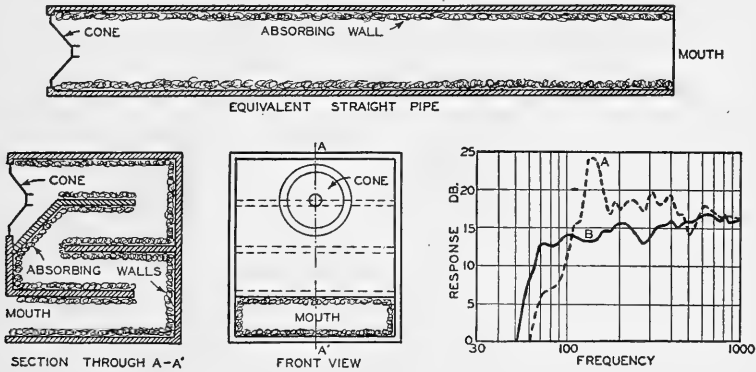

FIG. 7.12. Acoustical labyrinth loud speaker. The equivalent straight axis damped pipe is shown above. The pressure response characteristic of the labyrinth loud speaker is labeled *B* on the graph. The pressure response characteristic of the corresponding cabinet loud speaker is labeled *A* on the graph. (After Olney.) (Courtesy of The Blakiston Company from Olson and Massa, "Applied Acoustics.")

nances. The transmission through the tube is very low above 150 cycles. An anti-resonance occurs when the tube is one quarter wavelength long. The deleterious effect of the fundamental resonance of the cone with its suspension system upon the response may be eliminated by choosing the constants so that fundamental resonance of the loud speaker coincides with the quarter wavelength anti-resonance of the tube. The response characteristic of a direct radiator loud speaker with and without a labyrinth is shown in Fig. 7.12. These characteristics show that the accentuated response due to cabinet resonance has been eliminated and that the low frequency range has been extended.

**7.13. Combination Horn and Direct Radiator Loud Speaker<sup>7</sup>.** — The combination horn and direct radiator loud speaker consists of a horn coupled to the back side of a direct radiator loud speaker mechanism and

<sup>7</sup>Olson and Hackley, *Proc. Inst. Rad. Eng.*, Vol. 24, No. 12, p. 1557, 1936.

an acoustic capacitance for changing the output from the horn to the open side of the cone for reproduction of the mid and high frequency ranges (Fig. 7.13). At low frequencies the reactance of the acoustic capacitance, equivalent circuit, Fig. 7.13, is large compared to the impedance  $z_{A1}$  at the throat of the folded horn. Therefore, the cone is coupled directly to the horn in this range. The combination of a horn and cone loud speaker mechanism yields high efficiency and smooth response at the low frequencies. In the system shown in Fig. 7.13 at 150 cycles the reactance of the acoustic capacitance  $C_{A1}$  becomes equal to the throat impedance  $z_{A1}$ .

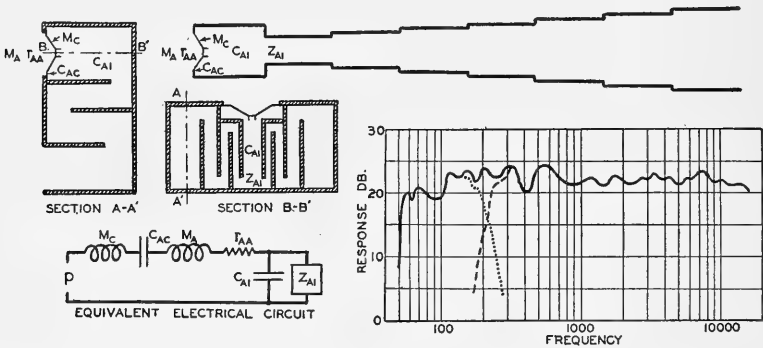

FIG. 7.13. Sectional views of the combination horn and direct radiator loud speaker. The straight axis equivalent of the folded horn is shown above. In the equivalent electrical circuit of the acoustical system:  $M_C$  the inertance of the cone.  $C_{AC}$  the acoustic capacitance of the cone suspension.  $M_A$  and  $r_{AA}$  the inertance and the acoustic resistance of the air load upon the front of the cone.  $C_{A1}$  the acoustic capacitance of the chamber behind the cone.  $z_{A1}$  the impedance at the throat of the horn. The driving pressure  $p$  in the acoustical system is the force generated in the voice coil divided by the area of the cone. The graph shows the pressure response characteristic of the combination horn and direct radiator loud speaker. The overlap between horn and direct radiator action is shown by the dotted and dashed characteristics. (After Olson and Hackley.) (Courtesy of The Blakiston Company from Olson and Massa "Applied Acoustics.")

Therefore, above 150 cycles the response from the horn is attenuated. The major portion of the output above 150 cycles issues from the front of the cone and the system behaves as a simple direct radiator loud speaker. The use of a horn as coupling means between the cone and the air makes it possible to obtain large power outputs from a small diameter cone. A small diameter cone is particularly suitable for good efficiency, wide angle distribution and smooth response as a direct radiator loud speaker for the mid and high frequency ranges. A cone with a single coil may be used for reproduction to 7000 cycles. For reproduction to 12,000 cycles a

double voice coil is used. The response characteristic of this loud speaker with a double voice coil is shown in Fig. 7.13.

**7.14. Feedback Applied to a Loud Speaker.** — Feedback in a transmission system or a section thereof is the returning of a fraction of the output to the input. Negative feedback is feedback which results in decreasing the amplification. Among the sources of nonlinear distortion and nonuniform response in a reproducing system may be the power amplifier and loud speaker. It is possible to reduce distortion and improve the response as a function of the frequency of an amplifier by making the amplification deliberately higher than necessary and then feeding the output back in such a way as to throw away excess gain. In the same way this system may be made to include the loud speaker. It is not an easy proposition

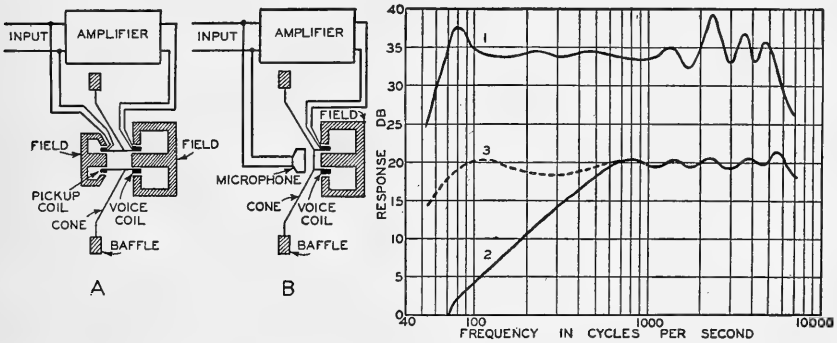

FIG. 7.14. Loud speaker and amplifier feedback systems. *A*. The output of the pickup coil is fed into the input side of the amplifier. *B*. The output of the microphone is fed into the input side of the amplifier. The graph shows the pressure response characteristics of system *A*: 1. without feedback, 2. with feedback, 3. with feedback and compensation.

to employ feedback in this way because of the very special control required of phase shifts in the amplifier and loud speaker system. Unless certain phase relations<sup>8,9</sup> are maintained, oscillation will occur. Figure 7.14 shows feedback applied to an amplifier and loud speaker. In Fig. 7.14*A* a pickup coil is attached to the cone. The output from the pickup coil is fed into the input of the amplifier out of phase with the signal input. The response characteristic of the amplifier loud speaker without feedback is shown in Fig. 7.14. The same loud speaker and amplifier with 15 db negative feedback from the pickup coil are also shown in Fig. 7.14. It will be

<sup>8</sup> Nyquist, H., *Bell Syst. Tech. Jour.*, Vol. 11, No. 1, p. 126, 1932.

<sup>9</sup> Black, H. C., *Bell Syst. Tech. Jour.*, Vol. 13, No. 1, p. 1, 1934.

seen that the response at the high frequencies is improved. This system tends to drive the cone at constant velocity for constant signal voltage input. Therefore, the response will fall off below the point of ultimate resistance, because the radiation resistance falls off 6 db per octave in this range. See Fig. 7.1. The response may be made uniform with respect to frequency by compensation of the input to the system.

A feedback system employing an amplifier, loud speaker and microphone is shown in Fig. 7.14B. If a pressure operated microphone having uniform sensitivity with respect to frequency is used the response characteristic of the loud speaker will become more uniform as the amount of feedback is increased.

**7.15. Nonlinear Distortion.** — Acoustical and electrical networks are assumed to be invariable; that is, the constants and connections of the network or system do not vary or change with time. In one type of variable-circuit element the variations which occur are controlled by outside forces which do not appear in the equations or statements of the

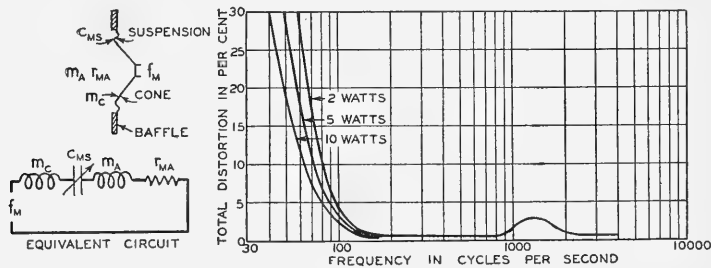

FIG. 7.15. Cross-sectional view of the vibrating system of a dynamic loud speaker mounted in a large baffle. In the equivalent circuit:  $m_C$  the mass of the cone and coil.  $m_A$  and  $r_{MA}$  the mass and the mechanical resistance of the air load.  $C_{MS}$  the compliance of the suspension.  $f_M$  the mechanical driving force. The equivalent circuit indicates the effect of the nonlinear element  $C_{MS}$ . The graph shows the distortion frequency characteristics for inputs to the voice coil of 2, 5 and 10 watts respectively.

problem. In another type of variable-circuit element, the variation is not an explicit time function, but a function of the current and its derivatives which is flowing through the circuit.

The outside diaphragm suspension is an example of the latter type of variable-circuit element. It appears that practically all types of suspension systems are nonlinear. The stiffness is not a constant, but is a function of the amplitude and in general increases for the larger amplitudes. A conventional dynamic loud speaker and the equivalent electrical circuit are shown in Fig. 7.15. Above the fundamental resonance frequency the

velocity is not appreciably affected by the suspension because the reactance of the compliance  $C_{MS}$  is small compared to the impedance of the remainder of the system. Below the resonance frequency the reactance of the compliance is the controlling impedance. In this range the nonlinear characteristics of the suspension will be most marked. The characteristics of Fig. 7.15 show the total distortion for 2, 5 and 10 watts input to the loud speaker. The distortion increases with input and with decrease of the frequency. The fundamental resonance frequency of this loud speaker occurred at 80 cycles. It will be seen that the distortion is very small above the resonance frequency where the influence of the suspension compliance is small. The distortion due to the suspension system may be obviated by placing the fundamental resonance frequency of the loud speaker at the lower limit of the reproduction range.

Inhomogeneity of the flux density through which the voice coil moves is another source of distortion. The result is that the driving force does not correspond to the voltage developed by the generator in the electrical driving system. Furthermore, the motional impedance is a function of the amplitude. This type of distortion can be eliminated by making an air gap of a sufficient axial length so that the voice coil remains at all times in a uniform field. This type of distortion can also be eliminated by making the voice coil longer than the air gap so that the summation of the products of each turn and the flux density is a constant. See Sec. 8.3D.

The distortions referred to above have been concerned with higher harmonics, that is, multiples of the fundamental. It has been analytically shown by Pederson<sup>10,11</sup> that subharmonics are possible in certain vibrating systems. The existence of subharmonics in direct radiator loud speakers is quite well known. It has been noticed that, by impressing a steady tone upon a system which produces both subharmonics and higher harmonics, the subharmonics are more pronounced and objectionable to the ear than the higher harmonics. However, by actual measurement under these conditions the subharmonic was less than one per cent, while the higher harmonics were several per cent of the fundamental. The explanation appears to be that it is more difficult to mask a low tone with a high tone than the reverse procedure. Another feature of subharmonic phenomena is the relatively long time required for "build up." Conventional sound reproduction does not usually require the reproduction of a single isolated high frequency tone of long duration. For examples of subharmonic distortion see Sec. 8.3E.

<sup>10</sup> Pederson, P. O., *Four. Acous. Soc. Amer.*, Vol. 6, No. 4, p. 227, 1935.

<sup>11</sup> Pederson, P. O., *Four. Acous. Soc. Amer.*, Vol. 7, No. 1, p. 64, 1936.

**7.16. Transient Response.** — The subject of transient response embraces a wide variety of physical phenomena. Electric transients concern electrical circuits and the components of electrical systems. Acoustic transients concern acoustical and mechanical systems. In view of the fact that the sound reproducing and collecting systems are mechanical, the general tendency is to assume that these systems exhibit very poor transient response characteristics. In properly designed acoustical elements the performance is very often far superior to the other components used in sound reproducing systems.

The behavior of a loud speaker may be analyzed by solving the differential equations of the dynamical system. In other words, find the velocities of the elements of the system which, when substituted in the differential equations, will satisfy the initial and final conditions. The solution of a differential equation may be divided into the steady state term and the transient term. The operational calculus is of great value in obtaining the transient response of a mechanical or acoustical system to a suddenly impressed force or pressure.

The general analysis used by Heaviside is applicable to any type of vibrating system whether electrical, mechanical or acoustical. It is the purpose of this section to show the response of the conventional direct radiator loud speaker to a suddenly applied unit force.

The equivalent circuit of the dynamic loud speaker at the low frequencies is shown in Fig. 7.3. The differential equation for the system of Fig. 7.3 is

$$m\ddot{x} + r_{MT}\dot{x} + \frac{x}{C_M} = f_{MO} \quad 7.12$$

where  $x$  = displacement,

$f_{MO}$  = mechanical driving force, in dynes,

$m$  = mass, in grams,

$C_M$  = compliance of the suspensions system, in centimeters per dyne, and

$r_{MT}$  = total mechanical resistance, mechanical ohms.

The total mechanical resistance is

$$r_{MT} = r_{MS} + r_{MR} + r_{ME} \quad 7.13$$

where  $r_{MS}$  = mechanical resistance due to losses in the suspension system, etc., in mechanical ohms,

$r_{MR}$  = mechanical radiation resistance, in mechanical ohms, and

$r_{ME}$  = mechanical resistance due to the electrical system, in mechanical ohms.

The mechanical resistance  $r_{SM}$  is the sum of all the losses in the suspension, the viscosity of the grill and cloth coverings and the viscosity loss due to the air forced through the slit formed by the air gap and voice coil.

From equation 7.6 the mechanical impedance  $z_{ME}$  due to the electrical circuit is

$$z_{ME} = r_{ME} = \frac{(Bl)^2}{r_{ET}} \quad 7.14$$

where  $B$  = flux density, in gausses,

$l$  = length of the voice coil conductor, in centimeters,

$r_{ET} = r_{ED} + r_{EG}$ ,

$r_{ED}$  = damped resistance of the voice coil, in abohms, and

$r_{EG}$  = internal resistance of the generator (the vacuum tube), in abohms.

The mechanical radiation resistance  $r_{MR}$  is given by equation 5.10. It may be obtained directly from the graph of Fig. 5.1.

The mass  $m$  is the sum of the cone mass and the mass of the air load upon the cone. The mechanical mass reactance of the air load upon a cone may be obtained from equation 5.10. It may be obtained directly from the graph of Fig. 5.1.

Heaviside's unextended problem<sup>12,13</sup> is as follows: Given a linear network of  $n$  meshes in a state of equilibrium, find its response when a unit force is applied to any mesh. The unit function is defined to be a force which is zero for  $t < 0$  and unity for  $t \geq 0$ .

The indicial mechanical admittance of the circuit of Fig. 7.3 is

$$A(t) = \frac{1}{r_{MT} + mp + \frac{1}{C_M p}} \quad 7.15$$

where  $p$  is employed as a symbol for the differentiation with respect to the independent variable, time.

Let

$$\alpha = \frac{r_{MT}}{2m}$$

$$\omega = \sqrt{\frac{1}{mC_M} - \alpha^2}$$

<sup>12</sup> Carson, "Electric Circuit Theory and Operational Calculus," McGraw-Hill Book Co., New York.

<sup>13</sup> Bush, "Operational Circuit Analysis," John Wiley and Sons, New York.

The indicial admittance may be written

$$A(t) = \frac{1}{m\omega} \frac{p\omega}{(p + \alpha)^2 + \omega^2} \quad 7.16$$

From tables of operational formulas, the solution is

$$A(t) = \frac{1}{m\omega} \epsilon^{-\alpha t} \sin \omega t \quad 7.17$$

Figure 7.16 shows the effect of the impedance of the vacuum tube upon the transient response of a loud speaker. In this case the loud speaker is connected to the following generators: a very high impedance corresponding to pentode or Class "B" operation; a generator of one half the resistance

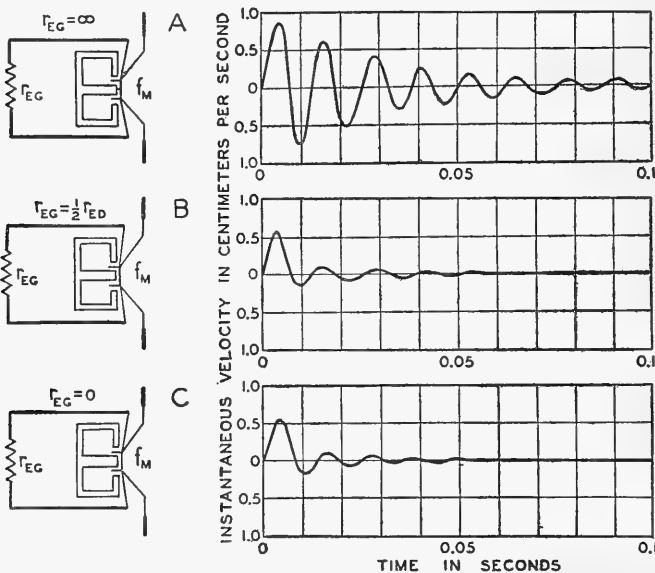

FIG. 7.16. The transient response of a 12-inch loud speaker to a unit force for various types of generators. *A.* Generator of very high resistance. *B.* Generator having a resistance of one-half of the loud speaker impedance. *C.* Generator of zero impedance.

of the loud speaker corresponding to class "A" operation; and to a generator of very low impedance corresponding to inverse feedback operation. The impedance characteristic of the loud speaker is shown by the uppermost left-hand graph of Fig. 7.17. This example shows that the damping



exerted by the electrical system is of consequence. However, there is very little difference between Class "A" and feedback operation.

When a loud speaker operates from a high impedance vacuum tube amplifier, the internal mechanical resistance of the loud speaker is the major factor influencing the transient response. Figure 7.17 shows response of a 12-inch (10-inch diameter cone) loud speaker to a unit force for various values of mechanical resistance. In order to correlate the

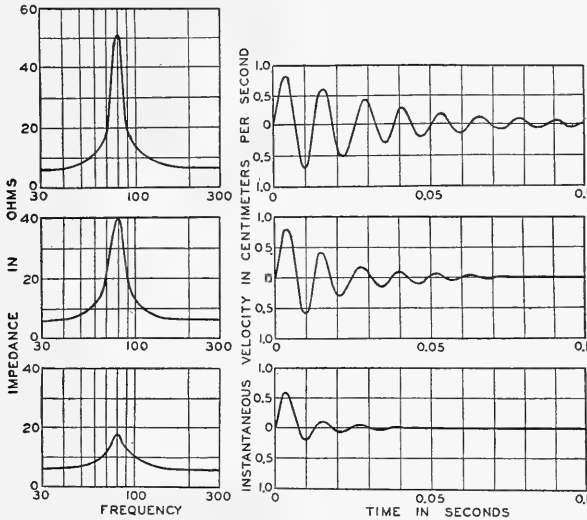

FIG. 7.17. The unit force response of a loud speaker coupled to a generator of very high resistance for different values of the internal mechanical resistance. The impedance frequency characteristics indicate the degree of internal damping.

response with actual systems, the impedance frequency characteristic for each system is also shown. These characteristics are for a loud speaker coupled to a generator with very high internal impedance. For this type of operation it is customary to provide a large mechanical resistance  $r_{MS}$ , the second and third conditions of Fig. 7.17.

Figures 7.16 and 7.17 show that the "hangover" in properly designed and operated loud speakers is very small. Of course, the systems are improved as the fundamental resonance frequency is lowered. In some of the small receivers employing relatively high impedance power amplifiers driving loud speakers having the fundamental resonance above 100 cycles,

the response to transients is usually very poor because the internal mechanical resistance is not sufficiently large. Of course, the steady state response with respect to frequency is usually not very smooth and the nonlinear distortion is quite large in these receivers. As a consequence, the poor transient response is masked by these distortions.

**7.17. Diaphragms (Cones) and Voice Coils.** — The diaphragm or cone of practically all direct radiator loud speakers in use to-day is made of paper. The cone shown in Fig. 7.18*A* is made by a felting process and the cone and corrugated suspension are made in one piece. The corrugations in the conical portion of the diaphragm act as compliances. The portions between the compliances vibrate essentially as a whole. The resultant structure is then similar to that of a low pass filter. See Sec. 4.10*D*. The

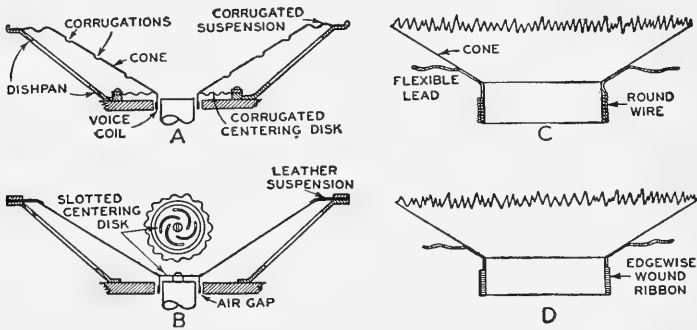

FIG. 7.18. Cones and voice coils. Sectional views. *A*. Felted paper cone. *B*. Developed paper cone with leather outside suspension. *C*. Voice coil wound with round wire. *D*. Voice coil with edgewise wound ribbon.

compliances serve to reduce the effective mass of the vibrating system. The corrugations also add rigidity to the cone in a radial direction. The cone shown in Fig. 7.18*B* is developed from a flat sheet of paper. A leather outside suspension is used with this cone. For voice coil and centering systems two general classes are used, namely: inside and outside suspensions. The inside suspension is some form of slotted disk. The outside suspension shown is a corrugated disk. Slotted disks are also used for outside suspensions.

The simplest voice coil construction consists of round enameled wire wound on a paper cylinder (Fig. 7.18*C*). The ends of the voice coil are soldered to flexible leads anchored to the cone. The ratio of the volume of the conductor in the air gap to the air gap volume should be as large as possible to make efficient use of the air gap flux. Certain reasonable

clearances are required which introduce a loss. In addition, the space factor in round wire introduces a loss. By using edgewise wound ribbon, Fig. 7.18D, the space factor is improved and more conductor can be placed in the air gap.

**7.18. Field Structures.** — Five typical electromagnetic and permanent magnet field structures are shown in Fig. 7.19. The most widely used field structure for use with direct radiator loud speakers is depicted in Fig. 7.19A. During the past few years materials for permanent magnets

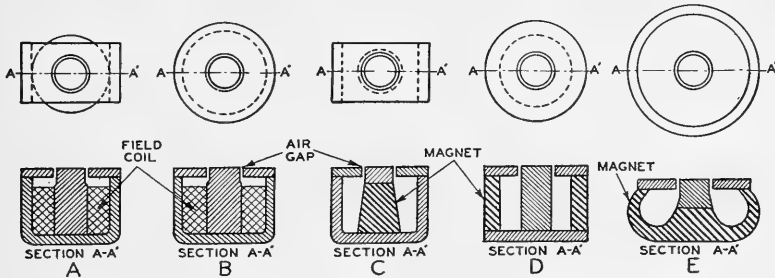

FIG. 7.19. Field structures. *A* and *B* electromagnetic type; *C*, *D* and *E*, permanent magnet type.

have been improved and it is now possible to obtain high flux densities in structures of reasonable size. These new alloys<sup>14</sup> are combinations of aluminum, nickel, cobalt and iron and have been termed "Alnico." Three typical magnet structures employing these alloys are shown in Figs. 7.19C, 7.19D and 7.19E. For the design of field structures the reader is referred to texts<sup>15</sup> on magnetic circuit design.

**7.19. High Frequency Sound Distributor**<sup>16</sup>. — The diameter of the vibrating surface of multiple cones decreases with increase in frequency and as a result the directional pattern is essentially independent of the frequency. See Sec. 7.3 and 7.5. When a single uncorrugated cone is used to cover the high frequency range the directional pattern becomes quite narrow at the higher frequencies. By means of a distributor consisting of vanes it is possible to spread the high frequency radiation and thereby maintain uniform directional characteristics with respect to the frequency. The high frequency contours of equal phase for a cone with and without a distributor is shown in Figs. 7.20A and 7.20B. The radius

<sup>14</sup> Adams, J. Q., *G. E. Review*, Vol. 41, No. 12, p. 518, 1938.

<sup>15</sup> Underhill, "Magnets," McGraw-Hill Book Co., New York.

<sup>16</sup> Olson, H. F., U. S. Patent 2,102,212.

of curvature of the wave front with the distributor being considerably less than that of the plain cone shows that the distributor broadens the radiation pattern. The vertical section, Fig. 7.20C, shows that the distributor

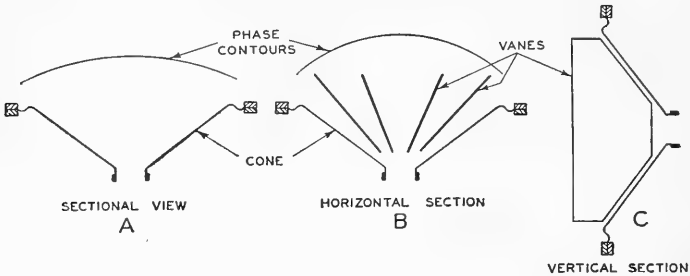

FIG. 7.20. High frequency sound distributors for direct radiator loud speakers. *A*. The contour of equal phase for a plain cone. *B*. The horizontal cross-sectional view of a cone with a vane distributor and the contour of equal phase. *C*. The vertical cross-sectional view of a cone with a vane distributor.

will not broaden the pattern in this direction. In general, in radio or phonograph reproduction the required vertical plane of spread is quite small. If a broader pattern is required in this plane crossed vanes may be used.

## CHAPTER VIII

### HORN LOUD SPEAKERS

**8.1. Introduction.** — Large scale reproduction of sound, involving several acoustical watts, is quite commonplace. Since high power audio frequency amplifiers are costly, it is logical to reduce the amplifier output to a minimum by the use of high efficiency loud speakers. At the present time, horn loud speakers seem to be the only satisfactory high efficiency system for large scale sound reproduction. A horn loud speaker<sup>1, 2, 3, 4, 5</sup> consists of an electrically or mechanically driven diaphragm coupled to a horn. The principle virtue of a horn resides in the possibility of presenting practically any value of acoustic resistance to the generator. This feature is extremely valuable for obtaining maximum overall efficiency in the design of the acoustic system. Employing a suitable combination of horns, directional characteristics which are independent of the frequency, as well as practically any type of directional pattern, may be obtained. The combination of high efficiency and the possibility of any directional pattern makes the horn loud speaker particularly suitable for large scale reproduction. For applications requiring high quality reproduction of intense sound, some consideration should be given to the introduction of frequencies not present in the output due to nonlinearity of the operating characteristics of the elements which constitute the vibrating system of the loud speaker. It is the purpose of this chapter to consider the principal factors which influence and govern the efficiency, distortion and power handling characteristics of a horn loud speaker and to describe several horn loud speaker systems.

**8.2. Efficiency**<sup>6, 7, 8</sup>. — The efficiency of a loud speaker is the ratio of the useful power output to the signal power input. For all large scale reproduction of sound, efficiency is an important consideration. Specifically,

---

<sup>1</sup> Hanna and Slepian, *Jour. A.I.E.E.*, Vol. 43, No. 3, p. 251, 1924.

<sup>2</sup> Wente and Thuras, *Bell Syst. Tech. Jour.*, Vol. 7, No. 1, p. 140, 1928.

<sup>3</sup> Olson, H. F., *Jour. Acous. Soc. Amer.*, Vol. 2, No. 4, p. 242, 1931.

<sup>4</sup> Wente and Thuras, *Jour. A.I.E.E.*, Vol. 53, No. 1, p. 17, 1934.

<sup>5</sup> Olson, H. F., *RCA Review*, Vol. 2, No. 2, p. 265, 1937.

<sup>6</sup> Wente and Thuras, *Jour. A.I.E.E.*, Vol. 43, No. 3, p. 251, 1924.

<sup>7</sup> Olson, H. F., *RCA Review*, Vol. 2, No. 2, p. 265, 1937.

<sup>8</sup> Massa, F., *Electronics*, Vol. 10, No. 4, p. 30, 1937.

the efficiency depends primarily upon the flux density, the mass and the density-resistivity product of the voice coil, the mass of the diaphragm, the ratio of the diaphragm to the throat area, the dimensions of the air chamber, the area of the diaphragm and the voice coil temperature. Some of the factors are interrelated and others are independent; as a consequence, it is impossible to depict in one set of characteristics the effect of the various parameters. Therefore, the design of a horn loud speaker is usually a long and tedious task. The labor is further increased when economic considerations are involved. It is believed that a general consideration of the problem, together with a series of characteristics, is valuable for initiating the design of a loud speaker and for facilitating the determination of the ultimate constants. The throat impedance and directional characteristics of a large number of representative horns were given in Secs. 5.19 and 2.8. From these characteristics it is possible to interpolate the characteristic of practically any horn and thus eliminate considerable initial work in the design of a horn loud speaker. It is the purpose of this section to consider the effect of the various parameters, referred to above, upon the efficiency of a horn loud speaker and to include characteristics depicting the influence of these parameters upon the performance.

A. *The Relation between the Voice Coil Mass, the Load Resistance and the Initial Efficiency.* — Initial efficiency is the ratio of sound power output to electrical power input in the system in which the mechanical reactance is negligible and in which all the mechanical resistance may be attributed to radiation. In most loud speakers the mechanical reactance of the vibrating system is negligible in the upper low frequency range. Near the cutoff of the horn the reactive component at the throat of the horn is relatively large. Furthermore, the mechanical reactance due to the stiffness of the diaphragm may be comparable to the other mechanical impedances in the system. Nevertheless, the starting point in most horn loud speaker designs is a determination of the initial efficiency. This is logical because the mechanical reactances referred to above are usually chosen so their effect upon the efficiency characteristic in the upper low frequency range is very small. It is the purpose of this section to discuss briefly the factors which influence the initial efficiency and to include a family of curves showing the effect of the flux density, the voice coil mass, the throat area, and the diaphragm diameter upon the initial efficiency. The motional impedance  $z_{EM}$ , in ohms, is given by (see Sec. 6.2).

$$z_{EM} = \frac{(Bl)^2}{z_M} \times 10^{-9} \quad 8.1$$

where  $B$  = flux density, in gaussses,  
 $l$  = length of wire in the voice coil, in centimeters, and  
 $z_M$  = mechanical impedance of the vibrating system, in mechanical ohms, at the point  $f_M$  Fig. 8.1.

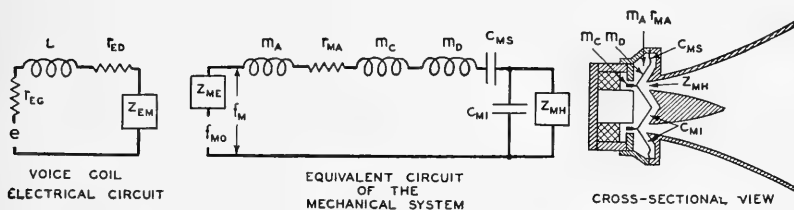

FIG. 8.1. Cross-sectional view of a horn loud speaker, the electrical circuit and equivalent electrical circuit of the mechanical system. In the voice coil circuit:  $e$  the internal voltage of the generator.  $r_{EG}$  the internal resistance of the generator.  $L$  the inductance of the voice coil.  $r_{ED}$  the damped resistance of the voice coil.  $z_{EM}$  the motional impedance. In the equivalent electrical circuit of the mechanical system:  $m_A$  and  $r_{MA}$  the mass and radiation resistance due to the air load on the back of the diaphragm.  $m_C$  and  $m_D$  the mass of the voice coil and diaphragm.  $C_{MS}$  and  $C_{M1}$  the compliance of the suspension and air chamber.  $z_{MH}$  the mechanical impedance at the throat of the horn.  $z_{ME}$  the mechanical impedance due to the electrical circuit.  $f_M$  the force generated in the voice coil.  $f_{M0}$  the force of the mechanical generator.

The efficiency  $\mu$ , in per cent, is

$$\mu = \frac{r_{EM}}{r_{ED} + r_{EM}} \times 100 \tag{8.2}$$

where  $r_{EM}$  = resistance component of the motional resistance, in ohms, and  
 $r_{ED}$  = damped resistance of the voice coil, in ohms.

In the equivalent electrical circuit, Fig. 8.1, the impedance  $z_M$  at  $f_M$  is given by

$$z_M = j\omega m_A + r_{MA} + j\omega m_C + j\omega m_D + \frac{1}{j\omega C_{MS}} + \frac{z_{MH}}{j\omega C_{M1} z_{MH} + 1} \tag{8.3}$$

where  $m_A$  = mass of the air load on the back of the diaphragm, in grams,  
 $m_C$  = mass of the voice coil, in grams,  
 $m_D$  = mass of the diaphragm, in grams,  
 $r_{MA}$  = resistance load on the back of the diaphragm, in mechanical ohms,  
 $C_{MS}$  = compliance of the suspension, in centimeters per dyne,  
 $C_{M1}$  = compliance of the air chamber, in centimeters per dyne,

$z_{MH} = r_{MH} + jx_{MH}$  = impedance of the throat of the horn, in mechanical ohms,

$r_{MH}$  = resistance of the throat of the horn, in mechanical ohms, and

$x_{MH}$  = reactance of the throat of the horn, in mechanical ohms.

For initial efficiency considerations, the reactance of the mechanical system is assumed to be negligible compared to the radiation resistance, that is,  $m_A$ ,  $m_C$ ,  $m_D$ ,  $C_{M1}$ ,  $1/C_{MS}$  and  $x_{MH}$  are zero.  $r_{MA}$  is also negligible. Then

$$z_M = r_{MH} = 42 \frac{A_D^2}{A_T} \quad 8.4$$

where  $A_D$  = area of the diaphragm, in square centimeters, and

$A_T$  = area of the throat, in square centimeters.

Substituting equations 8.1 and 8.4 in equation 8.2

$$\mu = \frac{B^2}{\left(\frac{42A_D^2 r_{ED}}{l^2 A_T}\right) 10^9 + B^2} \times 100 \quad 8.5$$

The resistance <sup>9</sup>  $r_{ED}$  is given by

$$r_{ED} = \frac{ql}{S} \text{ ohms} \quad 8.6$$

where  $q$  = resistivity of the voice coil material, in ohms, per centimeter cube,

$l$  = length of the conductor, in centimeters, and

$S$  = area of the conductor, in square centimeters.

Then (5) becomes

$$\mu = \frac{B^2}{\left(\frac{42A_D^2 q}{lS A_T}\right) 10^9 + B^2} \times 100 \quad 8.7$$

The mass of the coil,  $m_c$ , is

$$m_c = lS\rho \text{ grams} \quad 8.8$$

where  $\rho$  = density, in grams per cubic centimeter.

<sup>9</sup> The voice coil electrical circuit is shown in Fig. 8.1.  $r_{ED}$  is the total damped resistance of the voice coil and includes skin effect and hysteresis losses in the iron.  $L$  is the inductance of the voice coil. As shown in Fig. 7.4, the impedance of the voice coil increases at the high frequencies due to the reactance of  $L$  and an increase in resistance due to skin effect and hysteresis losses in the iron circuit. In order to simplify these considerations the damped resistance will be assumed to be the same as the ohmic (d.c.) resistance.



The efficiency may be written, employing equation 8.8, as

$$\mu = \frac{B^2}{\left(\frac{42A_D^2 q \rho}{m_c A_T}\right) 10^9 + B^2} \times 100 \tag{8.9}$$

For a particular material  $q\rho$  is a constant. Equation 8.9 gives the efficiency in terms of  $B^2$ ,  $m_c$ , and  $A_D^2/A_T$ . The efficiency as a function of  $A_D^2/A_T$  for aluminum voice coils of 0.1, 0.25, 0.5, 1, 2, 4, and 8 grams and flux

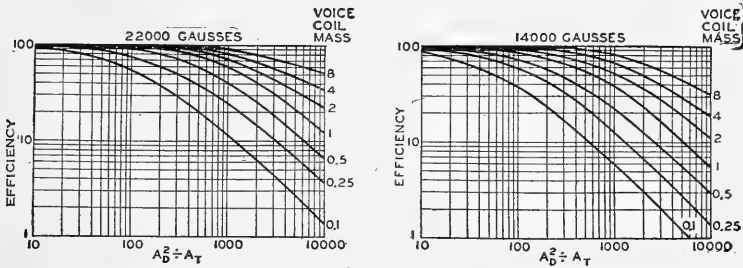

FIG. 8.2. The initial efficiency of a horn loud speaker as a function of  $A_D^2/A_T$  for aluminum voice coils having masses of 0.1, 0.25, 0.5, 1.2, 4, and 8 grams and flux densities of 22,000 and 14,000 gausses.  $A_D$  and  $A_T$  are the areas of the diaphragm and throat, respectively, in square centimeters. The above graphs may be applied to a copper voice coil by multiplying the ratio  $A_D^2 \div A_T$  by one-half.

densities of 22,000 and 14,000 gausses is shown in Fig. 8.2. The characteristics of Fig. 8.2 also apply to a copper voice coil if the abscissa are multiplied by 0.5. Equation 8.9 and Fig. 8.2 show the factors which influence the initial efficiency of a horn loud speaker.

**B. The Effect of the Mass of the Vibrating System upon the Efficiency.** — In the preceding section the mechanical reactance of the vibrating system was assumed to be negligible compared to the mechanical resistance. The mechanical mass reactance of the diaphragm and voice coil influences the efficiency when this mechanical reactance becomes comparable to the mechanical resistance. It is the purpose of this section to consider the effect of the mechanical reactance of the vibrating system upon the efficiency.

The real part of the motional impedance, equation 8.1, is

$$r_{EM} = \left( \frac{(Bl)^2 r_M}{r_M^2 + x_M^2} \right) 10^{-9} \text{ ohms} \tag{8.10}$$

where  $r_M$  = resistive component of the vibrating system, in mechanical ohms, and  
 $x_M$  = reactive component of the vibrating system, in mechanical ohms.

In this discussion, let

$$x_M = \omega (m_D + m_C) \quad 8.11$$

At the high frequencies the reactance due to  $C_{MS}$  and  $x_{MA}$  is negligible compared to the reactance due to the mass of the diaphragm. In order to divorce the effect of the air chamber from the effect of the mass of the diaphragm, the capacitance  $C_{A1}$  will be assumed to be zero. For the same reason  $r_{MA}$  will be assumed to be zero. These effects will be considered in following sections. The mechanical resistance  $r_M$  then becomes the horn throat resistance  $r_{MH}$ . The throat mechanical resistance is given by

$$r_{MH} = 42A_T \quad 8.12$$

where  $A_T$  = area of the throat, in square centimeters. Substituting equation 8.10 in 8.2, the efficiency becomes

$$\mu = \frac{(Bl)^2 r_{MH}}{r_{ED}(r_{MH}^2 + x_M^2)10^9 + (Bl)^2 r_{MH}} \times 100 \quad 8.13$$

This expression shows that the efficiency is a function of the flux density, the coil mass and material, the diaphragm mass, the throat resistance and the frequency. The efficiency characteristics for ratios of voice coil mass to diaphragm mass of 1 : 1 and 1 : 2, and flux densities of 22,000, 14,000 gauss for an aluminum voice coil is shown in Fig. 8.3. The characteristics of Fig. 8.3 are applicable to a copper voice coil by multiplying the abscissa by 0.5. In order to connect with the characteristics of initial efficiency of Fig. 8.2, these curves are depicted in terms of the initial efficiency (20, 40, 60, and 80 per cent). This data shows that it is comparatively simple to obtain high efficiencies at the lower frequencies. However, at the higher frequencies the efficiency is limited by the mass of the diaphragm and voice coil.

C. *The Effect of the Air Chamber upon the Efficiency*<sup>10, 11, 12, 13, 14</sup>. — The result of the preceding sections were obtained by assuming the capacitance

<sup>10</sup> Hanna and Slepian, *Jour. A.I.E.E.*, Vol. 42, No. 3, p. 251, 1924.

<sup>11</sup> Wentz and Thuras, *Bell Syst. Tech. Jour.*, Vol. 7, No. 1, p. 140, 1928.

<sup>12</sup> Olson, H. F., *Jour. Acous. Soc. Amer.* Vol. 2, No. 4, p. 242, 1931.

<sup>13</sup> Wentz and Thuras, *Jour. A.I.E.E.*, Vol. 53, No. 1, p. 17, 1934.

<sup>14</sup> Olson, H. F., *RCA Review*, Vol. 2, No. 2, p. 265, 1937.

of the air chamber to be zero. In general, it is impractical to design a high efficiency loud speaker to cover a wide frequency range without an air chamber, because the diaphragm area is usually larger than the throat area. In order to eliminate interference the dimensions of the elements of

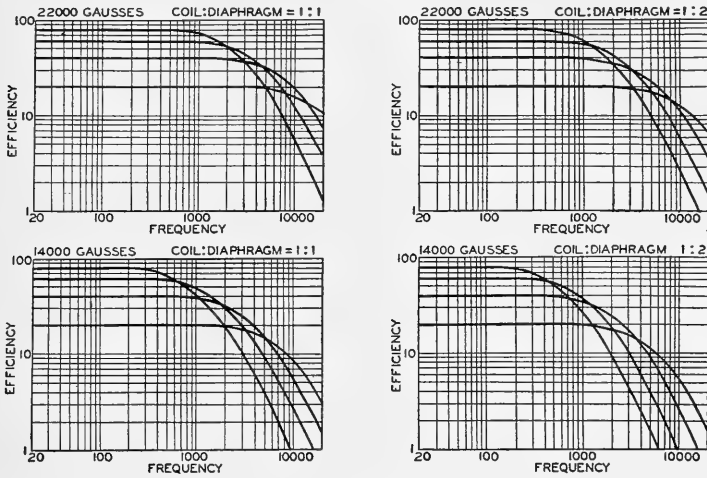

FIG. 8.3. The efficiency characteristics as a function of the frequency of a horn loud speaker system having a ratio of voice coil mass to diaphragm mass of 1 : 2 and 1 : 1, flux densities of 22,000 and 14,000 gaussses, and initial efficiencies of 20, 40, 60, and 80 per cent for an aluminum coil. The above graphs may be applied to a copper voice coil by multiplying the frequency by one-half.

the air chamber are usually made small compared to the wavelength. When these conditions obtain, the volume of the air chamber appears as a capacitance. At the higher frequencies, the mechanical impedance at the throat of the horn is resistive, the mechanical reactance of the suspension is very small and the mechanical impedance of the diaphragm system is a mass reactance. The equivalent circuit reduces to a mechanical resistance and compliance in parallel connected in series with a mass reactance. It is the purpose of this section to show the effect of the air chamber upon the efficiency from the standpoint of this equivalent circuit. The mechanical impedance of a mechanical resistance and capacitance in parallel, which is the equivalent circuit of the throat mechanical resistance and capacitance of the air chamber, is given by

$$z_M = \frac{r_{MH}}{1 + j\omega r_{MH} C_{M1}} \tag{8.14}$$

where  $r_{MH}$  = mechanical resistance at the horn throat, in mechanical ohms,  
and

$C_{M1}$  = compliance of the air chamber.

The throat mechanical resistance  $r_{MH}$  is given by equation 8.12. The mechanical compliance, Sec. 4.4, of the air chamber is given by

$$C_{M1} = \frac{V}{\rho c^2 A_D^2} \quad 8.15$$

where  $A_D$  = area of the diaphragm, in square centimeters,

$V$  = volume of the air chamber, in cubic centimeters,

$\rho$  = density of air, in grams per cubic centimeter, and

$c$  = velocity of sound, in centimeters per second.

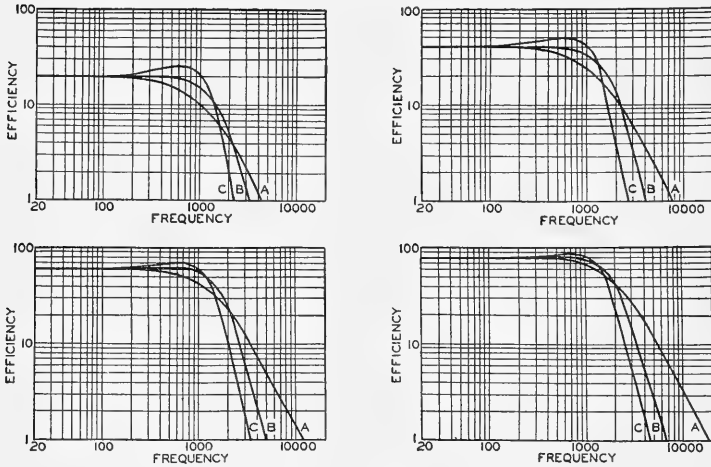

FIG. 8.4. The efficiency characteristics as a function of the frequency of a voice coil and diaphragm having a mechanical reactance of one ohm at 1000 cycles coupled to a throat of a horn having a mechanical resistance of one ohm and an air chamber having the following reactances: *A*. an infinite reactance. *B*. a capacitance reactance of one ohm at 2000 cycles and *C*. a capacitance reactance of one ohm at 1000 cycles for initial efficiencies of 20, 40, 60 and 80 per cent. These characteristics are applicable to other frequencies by multiplying the frequency by any number and multiplying the mass and the capacitance by the reciprocal of the number.

Referring to the system shown in Fig. 8.1, it is obvious that the effect of the air chamber will be to reduce the reactance of the system at the high frequencies and thereby increase the efficiency over a wide range. Figure 8.4 shows the efficiency characteristics of a system consisting of a voice coil and diaphragm having a mechanical reactance of 1 ohm at 1000

cycles coupled to the throat of a horn having a mechanical resistance of 1 ohm and an air chamber having a mechanical reactance of 1 ohm at 1000, 2000 and an infinite reactance for an initial efficiency of 20 per cent, 40 per cent, 60 per cent, and 80 per cent. These characteristics are applicable to other frequencies by multiplying the abscissa by any number and, of course, multiplying the mass and the capacitance by the reciprocal of the number. These characteristics are also applicable for other values of  $r$  and  $m$  by simply multiplying these two factors by the same number and the capacitance by the reciprocal of that number. The characteristics shown in Fig. 8.4 have included mass, compliance products which cover the useful range of values — larger products result in a peaked characteristic, smaller values do not show much deviation from zero value of capacitance.

D. *The Effect of the Generator Impedance and the Impedance at the Throat of the Horn upon the Efficiency.* — Due to the impracticability of a horn mouth diameter comparable to the wavelength for low frequency loud speakers, it is interesting to note that a relatively smooth output characteristic can be obtained from a horn having an impedance characteristic varying over wide limits. Near the cutoff of both finite and infinite exponential horns the radiation resistance at the throat is small and the positive reactance large. The compliance of the suspension system should be chosen so that its capacitive reactance balances the positive reactance due to the throat. For example, consider a moving coil mechanism coupled to the throat of a horn and fed by a vacuum tube amplifier; the sound power output is the real part of

$$\text{Power} = \left( \frac{e}{|z_{ET}|} \right)^2 z_{EM} \quad 8.16$$

where the motional resistance, in ohms,  $z_{EM}$  from equation 8.1, is

$$z_{EM} = \frac{(Bl)^2}{A^2(r_{AH} + jx_{AH}) + jx_M} 10^{-9}$$

where  $B$  = air gap flux, in gaussses,  
 $l$  = length of wire in the voice coil, in centimeters,  
 $A$  = area of the diaphragm, in square centimeters,  
 $r_{AH}$  = acoustic resistance at the throat, in acoustic ohms,  
 $x_{AH}$  = acoustic reactance at the throat, in acoustic ohms, and  
 $x_M$  = mechanical reactance of the diaphragm, suspension and coil system, in mechanical ohms.

From the voice coil electrical circuit, Fig. 8.1, the total electrical impedance  $z_{ET}$  in ohms at  $e$  is

$$z_{ET} = r_{ED} + r_{EG} + j\omega L + z_{EM}$$

where  $r_{ED}$  = voice coil resistance, in ohms,  
 $r_{EG}$  = amplifier output resistance, in ohms,  
 $L$  = inductance of the voice coil, in henries, and  
 $e$  = amplifier open circuit voltage, in volts.

Equation 8.16 shows that the throat acoustic resistance may vary over wide limits without introducing large variations in the power output. As

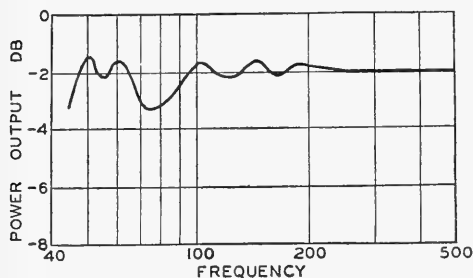

FIG. 8.5. Power output characteristic of the horn (Fig. 5.6B with all dimensions multiplied by  $2\frac{1}{2}$ ) coupled to a  $10\frac{1}{2}$ -inch diameter, 10-gram diaphragm driven by a 5-gram aluminum voice coil in a field of 20,000 gauss. Damped resistance of voice coil, 20 ohms. Impedance of vacuum tube through a transformer, 35 ohms.

a specific example, Fig. 8.5 shows the power output as a function of the frequency for a horn, having all dimensions two and one half times that of Fig. 5.6B and driven by a vacuum tube having the constants indicated by the caption of Fig. 8.5. Although the variation in acoustic resistance is 6 to 1 the variation power output is only 2 db.

#### E. The Effect of the Voice Coil Temperature upon the Efficiency<sup>15</sup>.

— The effect of the temperature of the voice coil upon the efficiency is usually ignored in considerations of the performance of a loud speaker. In high power loud speakers, where the temperature of the voice coil becomes quite high, considerable loss in efficiency may result as will be shown in the discussion which follows.

The efficiency of a loud speaker, when the temperature correction is added, may be expressed

$$\mu = \frac{r_{EM}}{r_{ED0}(1 + \alpha t) + r_{EM}} \quad 8.17$$

where  $r_{ED0}$  = damped resistance of the voice coil at  $0^\circ$  Centigrade,  
 $\alpha$  = temperature coefficient of resistance, 0.00423 for aluminum and 0.00427 for copper,

<sup>15</sup> Olson, H. F., *RCA Review*, Vol. 1, No. 4, p. 68, 1937.

$t$  = temperature of the voice coil, in degrees Centigrade, and  
 $r_{EM}$  = motional resistance of the voice coil.

The efficiency as a function of the temperature for various values of initial efficiency at 0° Centigrade is shown in Fig. 8.6. These characteristics show that the relative losses in efficiency with increase in temperature is considerably greater for a loud speaker with low efficiency.

F. *The Effect of the Radiation from the Unloaded Side of the Diaphragm upon the Efficiency.* — In the consideration of the efficiency, usually very little cognizance is taken of the radiation from the back of the diaphragm

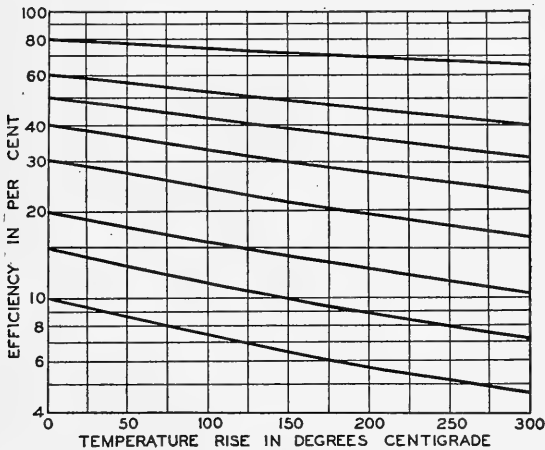

FIG. 8.6. The efficiency as a function of the temperature of the voice coil for various values of initial efficiency at 0° Centigrade.

of a horn loud speaker. In view of the large amount of sound that is radiated from the back of the diaphragm, some consideration should be given to the effect of this radiation upon the efficiency. Since this radiation cannot be used, it must be considered as a loss the same as the resistance loss in the voice coil. The loss due to the reactive component is usually small compared to the reactance of the remainder of the system.

The radiation from the back of the diaphragm may be assumed to be the same as that from a piston in an infinite baffle. See Sec. 5.7 and Fig. 5.1. The percentage of the total radiation which is lost due to the radiation from the back is given by

$$\text{Efficiency loss} = \frac{r_{MA}}{r_{MA} + r_{MH}} \times 100 \quad 8.18$$

where  $r_{MH}$  = radiation resistance at the throat of the horn, and  
 $r_{MA}$  = radiation resistance of the back of the diaphragm from Sec. 5.7.  
 Both in the same units.

The characteristics depicting the loss due to radiation from the back of the diaphragm for diameters of 2, 4, 8, and 16 inches and various ratios of

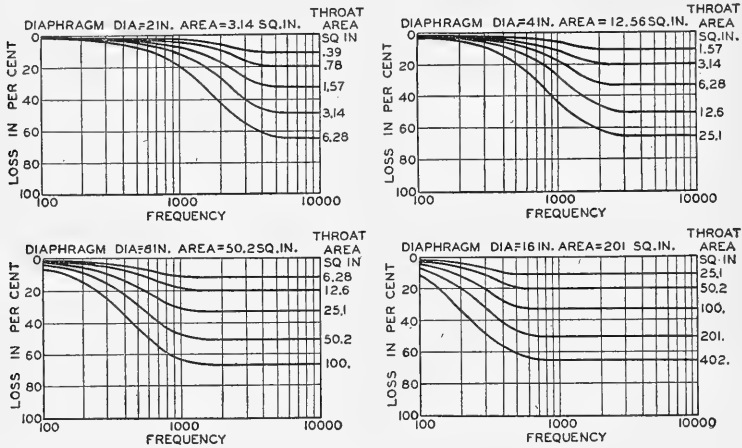

FIG. 8.7. Characteristics depicting the loss in per cent of the total radiation, due to the radiation of sound from the back of the diaphragm of a horn loud speaker for diameters of 2, 4, 8 and 16 inches and throat areas of 2, 1,  $\frac{1}{2}$ ,  $\frac{1}{4}$  and  $\frac{1}{8}$  times the diaphragm area.

throat area to diaphragm area are shown in Fig. 8.7. These characteristics show that the loss is indeed quite high.

**8.3. Nonlinear Distortion.** — In general, the power input to (or the power output of) a loud speaker is limited by the generation of spurious harmonics or subharmonics. The limiting factor may be due to air overload, excessive amplitudes where Hooke's law no longer holds, non-linear elements, variable voice coil air gap flux product or nonfundamental vibration modes of the diaphragm. It is the purpose of this section to consider the most common forms of nonlinear distortion in horn loud speakers.

A. *Distortion Due to Air Overload in the Horn*<sup>16, 17, 18</sup>. — A sound wave of large amplitude cannot be propagated in air without a change in the wave form and, as a result, the production of harmonics. If equal positive

<sup>16</sup> Rocard, *Comptes Rendus*, Vol. 196, p. 161, 1933.

<sup>17</sup> Thuras, Jenkins and O'Neil, *Four. Acous. Soc. Amer.*, Vol. 6, No. 3, p. 173, 1935.

<sup>18</sup> Goldstein and McLachlin, *Four. Acous. Soc. Amer.*, Vol. 6, No. 4, p. 275, 1935.



and negative changes in pressure are impressed upon a mass of air the resultant changes in volume will not be the same. The volume change for an increase in pressure will be less than the volume change for an equal decrease in pressure. From a physical viewpoint the distortion may be said to be due to the nonlinearity of the air.

In the derivation of the fundamental wave equation the second order terms were omitted. If these terms are included the magnitude of the harmonic frequencies may be determined from the differential equation. The subject has been investigated both theoretically and experimentally by a number of investigators. In the case of an exponential horn for constant sound power output, the distortion is proportional to the frequency. Further, the nearer the observation frequency is to the cutoff frequency the smaller the distortion.

The distortion due to nonlinearity of the air is at the present time one of the most important as well as the most troublesome factors in the design of high efficiency loud speakers for large outputs. In order to obtain high efficiency, particularly at the higher frequencies, it is necessary to couple the relatively heavy diaphragm to a throat small in area compared to the diaphragm. For a certain allowable distortion the power output is directly proportional to the area of the throat. Obviously, to deliver large sound outputs with small distortion requires a very large throat which may be suitably coupled to a correspondingly large diaphragm or a large number of lightly driven small throat units.

The power<sup>19</sup> which can be transmitted per square centimeter of throat area of an infinite exponential horn as a function of the ratio of the frequency under consideration to the cutoff frequency with the production of 1, 3 and 10 per cent distortion is shown in Fig. 8.8. For the sake of generality the curves shown in Fig. 8.8 refer to an infinite horn. However, the increase in power which may be transmitted by a practical finite horn is only a few per cent greater than that shown in Fig. 8.8, because very little distortion is generated in the large cross-sectional area near the mouth of the horn.

It may be mentioned in passing that the multiple flare horn (see Sec. 5.23) provides a means of decreasing the distortion because the rate of flare is very rapid near the diaphragm and, therefore, the pressures are rapidly reduced with respect to the distance from the diaphragm.

*B. Distortion Due to Variation in Volume of Air Chamber*<sup>20</sup>.— In general, acoustical, mechanical and electrical networks are assumed to be invariable;

<sup>19</sup> Olson, H. F., *RCA Review*, Vol. 2, No. 2, p. 265, 1937.

<sup>20</sup> Olson, H. F., *RCA Review*, Vol. 2, No. 2, p. 265, 1937.

that is the constants and connections of the network do not vary or change with time. A network which includes a circuit element that varies continuously or discontinuously with time is called a variable network. In some cases the variable elements are assumed to be certain functions of

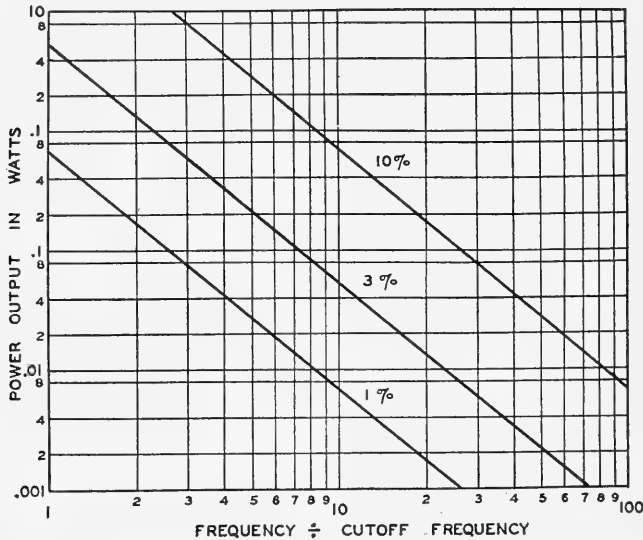

FIG. 8.8. The power output of infinite exponential horns, per square centimeter of throat area, for 1, 3 and 10 per cent distortion, as a function of the ratio of the frequency under consideration to the cutoff frequency.

the time; that is, the variations are controlled by outside forces which do not appear in the equations or statement of the problem. In another type of variable circuit element the variation is not an explicit time function, but a function of the current (and its derivatives) which is flowing through the circuit.

An example of the latter type of circuit element in an acoustical system is the air chamber capacitance in a horn loud speaker. The excursions of the diaphragm changes the capacitance. The acoustic capacitance of the air chamber of Fig. 8.9 is given by

$$C_A = \frac{V}{\rho c^2} = \frac{A(d+x)}{\rho c^2} \quad 8.19$$

where  $\rho$  = density of air, in grams per cubic centimeter,  
 $c$  = velocity of sound, in centimeters per second,  
 $V$  = volume of the air chamber, in cubic centimeters,

- $A$  = projected area of the air chamber upon the diaphragm, in square centimeters,
- $d$  = distance between the diaphragm and front boundary of the air chamber in the absence of motion, in centimeters, and
- $x$  = displacement of the diaphragm, in centimeters.

The equivalent circuit of the mechanical system shows the effect of the nonlinear element upon the sound power output. In the case of a single frequency the distortion which this element introduces is small, because for constant sound power output the amplitude of the diaphragm is inversely proportional to the frequency. At low frequencies where the amplitude

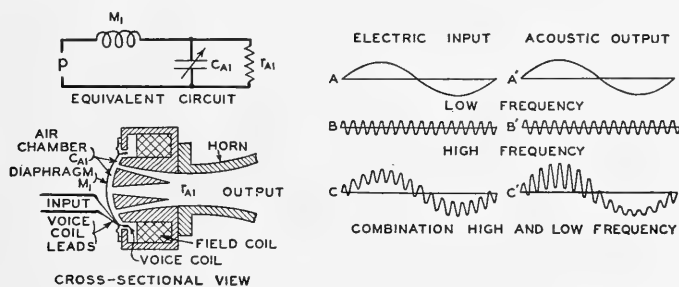

FIG. 8.9. A mechanism with an air chamber coupling the diaphragm to the horn. The variation in volume of the air chamber introduces a nonlinear element in the form of the acoustic capacitance  $C_{A1}$ . The equivalent electrical circuit indicates the effect of the nonlinear element upon the system. The wave shapes of the electrical input and the acoustical output for a low, high, and a combination of a high and a low frequency illustrates the effect of the nonlinear element upon the acoustical output.

of the diaphragm may be so large that the volume of the air chamber becomes alternately zero and two times the normal volume, the acoustic reactance of the acoustic capacitance is very small compared to the acoustic resistance of the horn. See Fig. 8.9. At the high frequencies where the acoustic reactance of the acoustic capacitance is comparable to the acoustic resistance, the amplitude of the diaphragm for the same output is so small that the variation in acoustic capacitance may be neglected. See Fig. 8.9. However, the conditions are different when both a high and a low frequency are impressed upon the same system. Under these conditions considerable change in capacitance occurs due to the large amplitudes of the diaphragm for the impressed low frequency. The resultant change in capacitance introduces a variable element for the impressed high frequency which may have variations in impedance as large as the impedance of the other elements of the system. The result is shown in Fig. 8.9. When this con-

dition obtains, particularly with close spacing between the diaphragm and the front boundary of the air chamber, the distortion may be tremendous. Physically the low frequency modulates the high frequency.

In the above discussion the air chamber is assumed to be a pure acoustic capacitance. This assumption is not correct at the higher frequencies where the dimensions of the air chamber are comparable to the wavelength. Regardless of the form of this acoustic impedance, it is, nevertheless, a function of the spacing between the diaphragm and the air chamber and is therefore a nonlinear element.

C. *Distortion Due to the Diaphragm Suspension System*<sup>21</sup>. — The outside suspension is another example of a variable circuit element in an acoustic system. In certain types or, as a matter of fact, for unlimited amplitudes in all types of suspension systems the stiffness is not a constant, but a

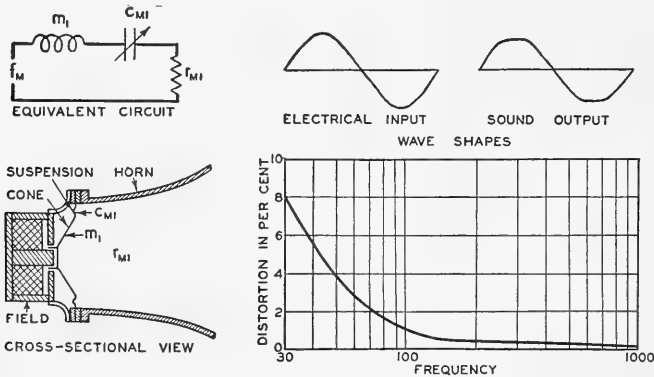

FIG. 8.10. Mechanism having a diaphragm with a nonlinear suspension system. Equivalent circuit of the vibrating system and the wave shapes indicates the effect of the nonlinear element. The graph shows a typical distortion characteristic obtained on an 8-inch diameter diaphragm coupled to a large throat horn and delivering an acoustic output of 3 watts.

function of the amplitude and, in general, increases for the larger amplitudes.

In the case of a horn loud speaker the amplitude of the diaphragm for constant sound power output is inversely proportional to the frequency. Furthermore, the mechanical impedance becomes comparable to the other impedances in the system at the lower frequencies. Consequently, the greatest distortion due to the suspension system will occur at the low frequency end of the working range.

<sup>21</sup> Olson, H. F., *RCA Review*, Vol. 2, No. 2, p. 265, 1937.

The equivalent circuit of the mechanical system, Fig. 8.10, shows the effect of the nonlinear element. When the stiffness of the suspension system increases with amplitude, the third harmonic is the preponderant distortion. The wave shape under these conditions is shown in Fig. 8.10. A distortion frequency characteristic of a diaphragm coupled to a large throat horn is shown in Fig. 8.10.

D. *Distortion Due to a Nonuniform Magnetic Field in the Air Gap.*— Inhomogeneity of the flux density through which the voice coil moves is another source of distortion. The result is that the driving force does not correspond to the voltage developed by the generator in the electrical system.

The force, in dynes, developed by the interaction of the current in the voice coil and the magnetic field is

$$f = Bli \quad 8.20$$

where  $B$  = flux density, in gausses,

$l$  = length of the voice coil conductor, in centimeters, and

$i$  = current, in amperes.

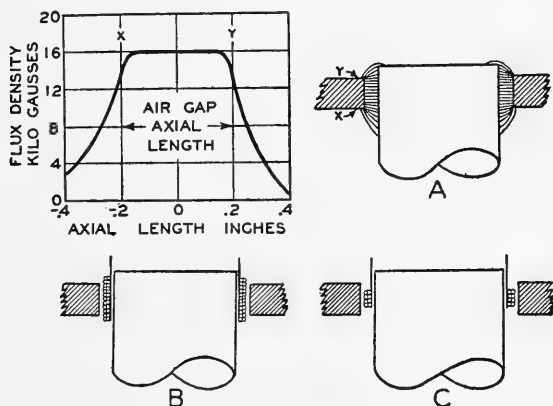

FIG. 8.11. Graph of the flux distribution in an air gap. *A.* Typical distribution of the flux lines in an air gap. *B.* A voice coil longer than the air gap. *C.* A voice coil shorter than the air gap.

Equation 8.20 shows that the force is directly proportional to the current if  $B/l$  is a constant. If the  $B/l$  product varies with the position of the voice coil the force will not be proportional to the current and distortion will result. A typical flux distribution in an air gap is shown in Fig. 8.11. A consideration of the flux distribution shows that the  $B/l$  product will be

practically a constant if the voice coil is made longer than the air gap, because as the coil moves into the weaker tufting field on one side it moves into a stronger field on the other side. From the standpoint of efficiency at the higher frequencies this method is not particularly desirable because part of the voice coil is in a weak field. This type of distortion can also be eliminated by making the air gap of sufficient axial length so that the voice coil remains at all times in a uniform field as shown in Fig. 8.11. The latter method is usually used for high frequency loud speakers of high efficiency. Also see Sec. 7.15.

E. *Subharmonic Distortion*<sup>22,23</sup>.—The distortions referred to above have been concerned with higher harmonics, that is, multiples of the fundamental. It has been analytically shown that subharmonics are

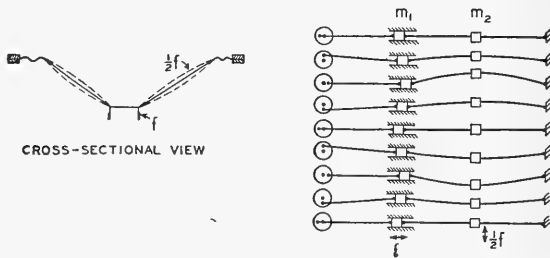

FIG. 8.12. A system consisting of a mass  $m_1$  driven by a crank at a frequency  $f$  and a second mass  $m_2$  supported by a spring coupled to  $m_1$  vibrating with a frequency  $\frac{1}{2}f$ . The cross-sectional view of the cone shows a similar system and illustrates how subharmonics may be produced by a loud speaker.

possible in certain vibrating systems. Figure 8.12 illustrates the mechanism of one type of subharmonic. The driven mass  $m_1$  at the end of the bar vibrates at a frequency  $f$  while the mass  $m_2$  vibrates at a frequency  $\frac{1}{2}f$ . In the same way a cone, Fig. 8.12, will vibrate at a subharmonic frequency. The existence of subharmonics in direct radiator loud speakers is well known. However, in horn loud speakers the diaphragms are relatively small and quite rigid. Consequently the conditions for the production of subharmonics are not particularly favorable. Circular corrugations in the diaphragm or cone may be used to increase the stiffness and thereby reduce the tendency to break into subharmonic vibrations. Also see Sec. 7.15.

<sup>22</sup> Pederson, P. O., *Jour. Acous. Soc. Amer.*, Vol. 6, No. 4, p. 227, 1935.

<sup>23</sup> Pederson, P. O., *Jour. Acous. Soc. Amer.*, Vol. 7, No. 1, p. 64, 1936.

F. *Power Handling Capacity and the Voice Coil Temperature*<sup>24</sup>. — The maximum allowable distortion may determine the power rating for the loud speaker. However, in certain loud speakers the maximum allowable temperature of the voice coil determines the power rating. This is particularly true of high frequency loud speakers.

By making the efficiency a maximum, the dissipation in, and the resulting temperature of, the voice coil for a certain acoustic output will be a minimum. Practically all the heat energy developed in the voice coil is transmitted across the thin air film between the voice coil and the pole

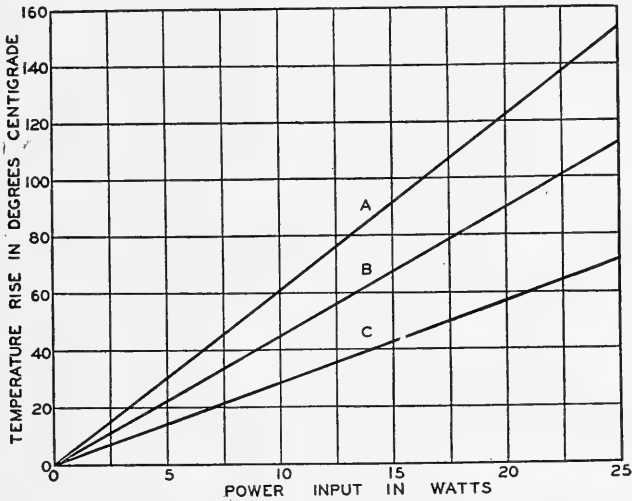

FIG. 8.13. The temperature rise as a function of the power delivered to a voice coil for air gap clearances as follows: A. 0.021 inch, B. 0.015 inch, C. 0.009 inch. Coil  $1\frac{1}{2}$  inch in diameter and 0.25 inch in length.

pieces and from the pole pieces to the field structure and thence into the surrounding air. In this heat circuit practically all the drop in temperature occurs in the thin air film. The temperature of the voice coil approaches the temperature of the pole pieces as the thickness of the air film is decreased. The temperature rises as a function of the power dissipated in the voice coil for various clearances between the voice coil and pole pieces is shown in Fig. 8.13. These results are obtained for no motion of the voice coil. When motion occurs, the thermal impedance of the air film is reduced and the temperature of the voice coil is diminished.

<sup>24</sup> Olson, H. F., *RCA Review*, Vol. 2, No. 2, p. 265, 1937.

G. *Power Handling Capacity and the Amplitude of the Diaphragm*<sup>25</sup>. — The maximum allowable amplitude of the diaphragm is another factor which may determine the maximum allowable power output. The power output, in watts, of a horn loud speaker in which the diaphragm is terminated in an acoustic resistance is

$$P = \frac{\rho c (2\pi f)^2 d^2 A_D^2}{2A_H} 10^{-7} \quad 8.21$$

where  $\rho$  = density, in grams per cubic centimeter,  
 $c$  = velocity of sound, in centimeters per second,  
 $f$  = frequency, in cycles per second,  
 $d$  = maximum amplitude from its mean position, in centimeters,  
 $A_D$  = area of the diaphragm, in square centimeters, and  
 $A_H$  = area of the throat of the horn, in square centimeters.

The amplitude of various diameter diaphragms coupled to a horn throat of one square inch for one acoustic watt output is shown in Fig. 8.14.

**8.4. Horn Loud Speaker Systems.** — A. *Single Horn, Single Channel System.* — The single horn, single channel system consists of a single horn driven by a single diaphragm. A diaphragm coupled to an exponential horn constitutes the simplest and most widely used system. The efficiency characteristic of a simple exponential horn coupled to a diaphragm and coil having a mass ratio of 2 operating in a field of 22,000 gauss is shown in Fig. 8.15. Two efficiency characteristics are shown with initial efficiencies of 80 per cent and 50 per cent. Although it is possible to obtain reasonably high efficiency over a wide range with a single flare horn coupled to a diaphragm, the efficiency can be increased by employing a multiple flare horn.

To obtain maximum efficiency in a horn loud speaker at any frequency, the effective reactance of the entire system should be equal to the effective resistance. This, in general, means that to obtain maximum efficiency the throat resistance of the horn should be proportional to the frequency, since the reactance is primarily mass reactance and, therefore, proportional to the frequency. The surge resistance of the exponential horn is independent of the frequency. However, the acoustic resistance<sup>26</sup> of a multiple flare horn increases with frequency as shown in Sec. 5.23. Therefore, the efficiency is higher over a wide range than in the case of a horn with a single rate of flare. The efficiency characteristic of the multiple flare horn described in Sec. 5.23 coupled to a diaphragm and coil having a mass ratio of 2 operating in a field of 22,000 gauss is shown in Fig. 8.16. This

<sup>25</sup> Massa, F., *RCA Review*, Vol. 3, No. 2, p. 196, 1938.

<sup>26</sup> Olson, H. F., *Four. Soc. Mot. Pict. Eng.*, Vol. 30, No. 5, p. 511, 1938.



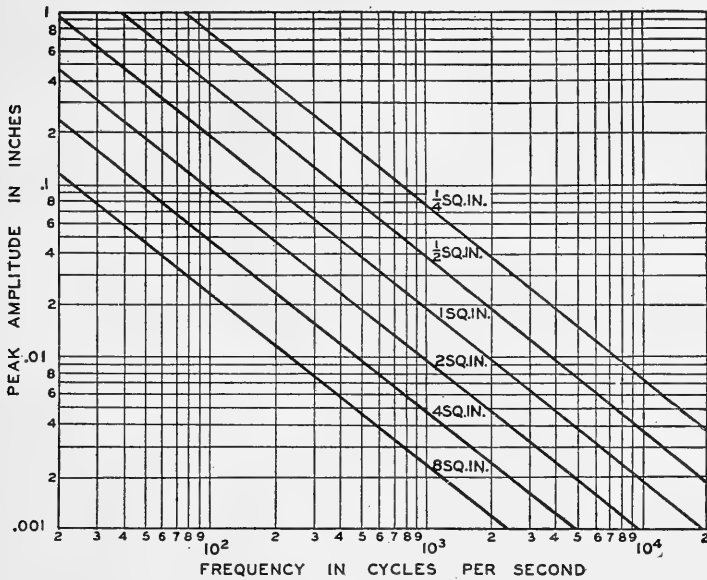

FIG. 8.14. The peak amplitude frequency characteristics of vibrating pistons of various areas in square inches, coupled to the throat of a horn having an area of one square inch, for one watt output.

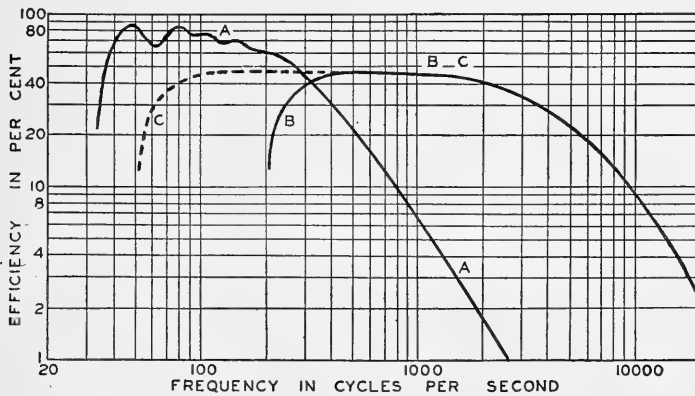

FIG. 8.15. *A*. Efficiency characteristic of a horn loud speaker employing the horn of Fig. 5.6D with the dimensions multiplied by three and driven by 4 cones, 12 inches in diameter, with 5 gram copper voice coils operating in a field of 14,000 gauss. *B*. Efficiency characteristic of a horn loud speaker employing the horn of Fig. 5.5D with the dimensions multiplied by one-half and driven by a diaphragm and an aluminum voice coil having a mass ratio of two to one operating in a field of 22,000 gauss. *C*. Same as *B* save that the horn dimensions of Fig. 5.5D are multiplied by two.

efficiency characteristic is only a few per cent below the ultimate efficiency characteristic obtained from the envelope of the family of characteristics shown in Fig. 8.3.

The two preceding horn loud speakers are suitable for high quality reproduction of speech and music. For certain types of announce installations it is desirable to project intelligible speech over very great distances (one

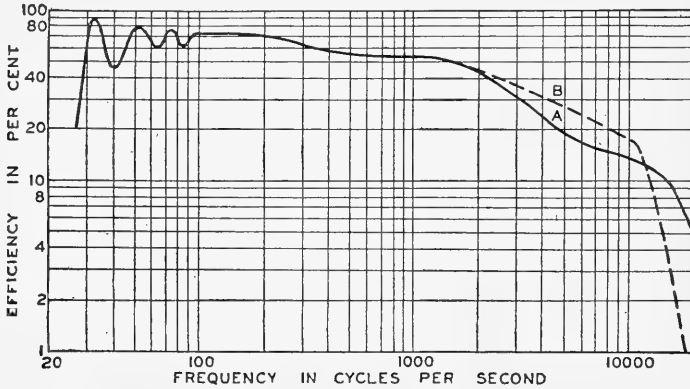

FIG. 8.16. Efficiency characteristic of a diaphragm coupled to the horn of Fig. 5.8 and driven by an aluminum voice coil of one-half the diaphragm mass in a field of 22,000 gaussess. A. Without air chamber. B. With air chamber.

to two miles) under all manner of conditions. This requires acoustic outputs of the order of from 500 to 1000 watts. The characteristics of Fig. 8.14 show that it is not practical to build a horn loud speaker of this

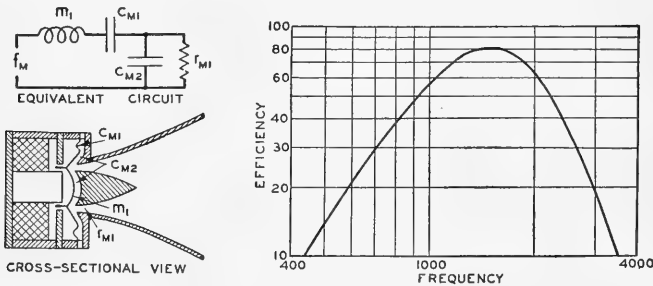

FIG. 8.17. Cross-sectional view and equivalent circuit of a loud speaker of two degrees of freedom. The graph shows the efficiency frequency characteristic.

capacity for the reproduction of the lower frequencies. A cross-sectional view of a high power announce loud speaker and the simplified equivalent circuit is shown in Fig. 8.17. The equivalent circuit shows a system of

two degrees of freedom. The compliance of the suspension system and the compliance of the air chamber are chosen so that very high efficiency is obtained over the range required for intelligible speech. A typical efficiency characteristic of this type of loud speaker suitable for acoustic outputs of 500 to 1000 watts is shown in Fig. 8.17. Due to the large audio power amplifier requirements, high loud speaker efficiency is an extremely important economic factor.

B. *Multiple Horn Multiple Channel System.*—The two channel or “two way” system<sup>27,28</sup> is the most common example of a multichannel

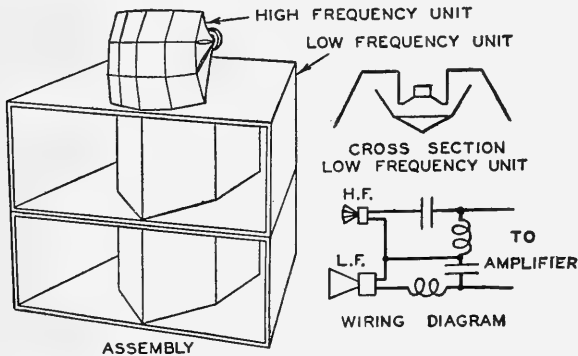

Fig. 8.18. A two channel theatre loud speaker system consisting of a folded low frequency horn unit and a multicellular horn high frequency unit. The circuit diagram shows the electrical filter used to allocate the power as a function of the frequency to the two units.

system. This loud speaker, Fig. 8.18, consists of a low frequency folded horn unit for reproduction from 40 to 300 cycles and a multicellular horn unit for reproduction from 300 to 8000 cycles.

In order to minimize time delay and phase distortion due to a large path length difference between the low and high frequency horns, the effective length of the low and high frequency horns must be practically the same. It has been found impossible to satisfy this requirement in practical multi-channel systems. The difference in path length in the system shown in Fig. 8.18 is made relatively small by employing a short folded horn coupled to a large diameter dynamic speaker mechanism. A further reduction in path length between a short straight axis high frequency horn may be obtained by shifting the high frequency unit backwards.

The high frequency horn consists of a cluster of relatively small horns

<sup>27</sup> Wente and Thurax, *Jour. A.I.E.E.*, Vol. 53, No. 1, p. 17, 1934.

<sup>28</sup> Hilliard, J. K., *Tech. Bul. Acad. Res. Coun.*, March, 1936.

coupled to a common throat, Fig. 8.18. The directional characteristics of this type of loud speaker were discussed in Sec. 2.9. Figure 8.18 shows a 12-cell high frequency unit. The throat is coupled to one or more mechanisms depending upon the power requirements.

An electric filter or dividing network is used to allocate the power to the high and low frequency units. The filter introduces phase shift as well as a loss in power of 2 or more db.

The efficiency characteristics of the high and low frequency units of this loud speaker without the filter are shown in Fig. 8.15, characteristics *B* and *A*.

*C. Compound Horn Loud Speaker*<sup>29</sup>. — The compound horn loud speaker consists of a single diaphragm mechanism with one side of the diaphragm

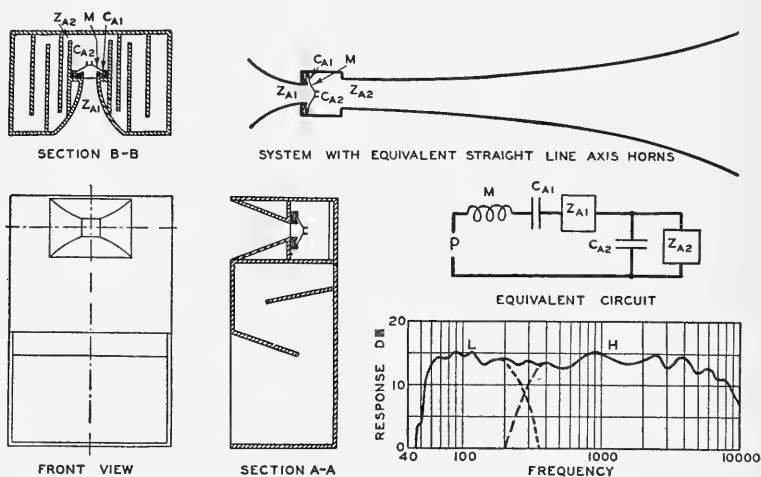

FIG. 8.19. Cross-sectional view of a compound horn loud speaker, the developed equivalent of the high and low frequency horns, and the equivalent circuit of the acoustical system. The sections A-A and B-B refer to the horizontal and vertical cross sections of the front view. The graph shows the frequency ranges of the high frequency and low frequency horns and the overall pressure response characteristic.

coupled to a straight axis horn and the other side coupled to a long folded horn, Fig. 8.19. The equivalent of the system is shown in Fig. 8.19. The functional equivalent circuit of the vibrating system is shown in Fig. 8.19. At the low frequencies the reactance of the acoustic capacitance  $C_{A2}$  is large compared to the throat acoustic impedance of the low frequency horn and sound radiation issues from the low frequency horn. At the high frequencies the reactance of the acoustic capacitance  $C_{A2}$  is small compared

<sup>29</sup> Olson and Massa, *Four. Acous. Soc. Amer.*, Vol. 8, No. 1, p. 48, 1936.

to  $z_{A1}$  and  $z_{A2}$  and, therefore, shunts out the low frequency horn and radiation issues from the high frequency horn. In the mid range, radiation issues from both horns. The response frequency characteristic, Fig. 8.19, shows the response range of the two horns. The throats of the two horns may be chosen so that the efficiency characteristic of this loud speaker will be the same as that of the two channel system discussed in the preceding section. However, the power handling capacity is somewhat smaller because the size of the diaphragm must be a compromise between high and low frequency requirements.

D. *Multiple Horn Single Channel System.*—The multiple horn single channel system consists of a large number of multiple flare horns, each

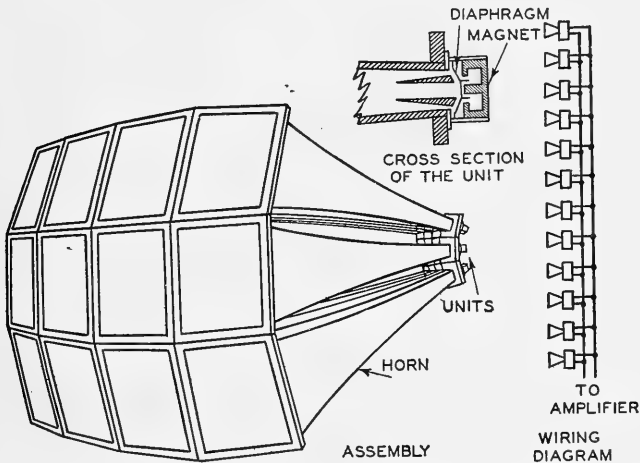

Fig. 8.20. A multiple horn, single channel system consisting of a cluster of multi-flare horns, each coupled to a small diaphragm.

driven by a diaphragm, Fig. 8.20. A comparison of the efficiency characteristics of a multiflare horn loud speaker, Fig. 8.16, with a multichannel system, Fig. 8.15, shows that the efficiencies are of the same order. The multiple horn single channel system eliminates many of the following disadvantages of the multichannel system: the phase difference due to the difference in path length between the two channels; the phase difference and power loss in the filters and dividing network; the nonuniform directional characteristics due to the small size of the high frequency unit; distortion in the relatively small throat of the high frequency horn. The space required for the single channel system is greater than that for the

multichannel system. However, from a technical standpoint the single channel system is far superior to the multiple channel system.

E. *Folded Horns*. — There are innumerable ways of folding or curling a horn. Two different types of folded horns are shown in Figs. 8.18 and 8.19. The principal purpose of folding or curling a horn is to use the volume occupied by the horn more efficiently. Three more different types of folding are shown in Fig. 8.21. A simple folded horn is shown in Fig. 8.21A. A folded horn with a ring shaped mouth is shown in Fig. 8.21B. The

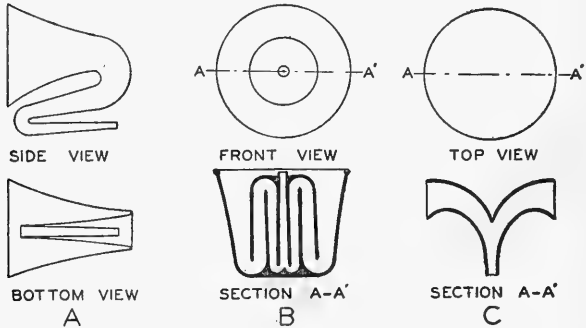

FIG. 8.21. Folded horns.

directional characteristics of a ring shaped mouth are sharper than those of the rectangular or circular shapes having equivalent areas. See Secs. 2.6 and 2.7. The horn shown in Fig. 8.21C is used for sending out radiation over  $360^\circ$  normal to the axis. It is customary to mount this loud speaker on a pole.

The high frequency response is usually attenuated in a folded horn due to destructive interference incurred by the different path lengths of the sounds traversing the bends. In order to eliminate destructive interference the same phase should exist over any plane normal to the axis. This condition is practically satisfied providing the radial dimensions at any bend are a fraction of the wavelength. Wide range reproduction of sound requires a large mouth horn for efficient reproduction of low frequency sounds and small dimensions at the bends of a folded horn for efficient reproduction of high frequency sounds. Obviously, it is practically impossible to incorporate both of these features into a single folded horn. It is true that folded horns have been used for years, but, in general, the response at either or both the low or high frequency ranges has been attenuated.

F. *Diaphragms and Voice Coils.* — The diaphragm or cone of a horn loud speaker in use today is made of aluminum alloys, molded bakelite with various bases, molded styrol, fiber or paper. Typical diaphragm shapes are shown in Figs. 8.1, 8.9, 8.10 and 8.17. Both round wire and edgewise wound ribbon voice coils are used. See Sec. 7.17.

G. *Field Structures.* — The field structures shown in Fig. 7.19 and described in Sec. 7.18 are also used with horn loud speakers. In addition, certain special structures are used as, for example, Fig. 8.9. In this case the throat of the horn passes through the center pole. In general, it is customary to use higher flux densities in the air gap of horn loud speakers. Soft iron may be used for the pole tips of the air gap for air gap flux densities up to 20,000 gausses. For flux densities from 20,000 to 23,000 gausses special iron (Permandur)<sup>30</sup> may be used for the pole tips of the air gap to obtain these high flux densities efficiently.

H. *Horn Walls. Vibration and Absorption.* — In the theoretical analysis carried out in this chapter it has been assumed that the horn walls are rigid and nonabsorbing. In the case of certain materials such as wood, paper and fiber the absorption of sound by walls of the horn may introduce an attenuation of several decibels. The absorption may be reduced by the application of lacquers and varnishes. The attenuation in metallic horns due to dissipation is negligible. The vibration of the walls of the horn distorts the response frequency characteristic and introduces "hangover" and reverberation. The response to transients is usually poor when the walls of the horn vibrate. This vibration may be reduced by increasing the thickness of the walls and by suitable bracing. The vibrations and ring in metallic horns may be reduced by coating the outside of the horn with deadening material such as asphalt or pitch compounds.

---

<sup>30</sup> Elmen, G. W., *Bell Syst. Tech. Jour.*, Vol. 15, No. 1, p. 113, 1936.

## CHAPTER IX

### MICROPHONES

**9.1. Introduction.** — A microphone is an electroacoustic transducer actuated by energy in an acoustic system and delivering energy to an electrical system, the wave form in the electrical system being substantially equivalent to that in the acoustic system. A pressure microphone is a microphone in which the electrical response is caused by variations in pressure in the actuating sound wave. A velocity microphone is a microphone in which the electrical response corresponds to the particle velocity resulting from the propagation of a sound wave through an acoustic medium. All microphones in use to-day may be classified as follows: pressure, velocity or a combination pressure and velocity. For the conversion of the acoustic variations into the corresponding electrical variations the following transducers may be used: carbon, magnetic, dynamic, condenser, crystal, magnetostrictive and hot wire.

Microphones may also be classified as directional or nondirectional. The particular configuration of the acoustic elements which constitute the vibrating system determines the directional properties of the microphone. It is the purpose of this chapter to consider the microphones in most common use to-day from the standpoint of the above classifications.

**9.2. Pressure Microphones.** — A. *Carbon Microphones.* — A carbon microphone is a microphone which depends for its operation on the variation in resistance of carbon contacts. The high sensitivity of this microphone is due to the relay action of the carbon contacts. The carbon microphone is almost universally employed in telephonic communications where the prime requisite is sensitivity rather than uniform response over a wide frequency range. For high quality reproduction the distortion may be reduced by employing two buttons in a push-pull arrangement. It is the purpose of this section to consider single and double button carbon microphones.

1. *Single Button Carbon Microphone.* — A typical carbon microphone is shown in Fig. 9.1. The carbon button consists of a cylindrical cavity filled with carbon granules. The carbon granules are usually made from anthracite coal. The carbon granules make contact with the diaphragm and the cylindrical cup. Suitable washers are used to prevent leakage of



the carbon granules between the diaphragm and carbon cup without impeding the motion of the diaphragm. A displacement of the diaphragm produces a change in the pressure between the carbon granules which changes the resistance from granule to granule. The net result is a change

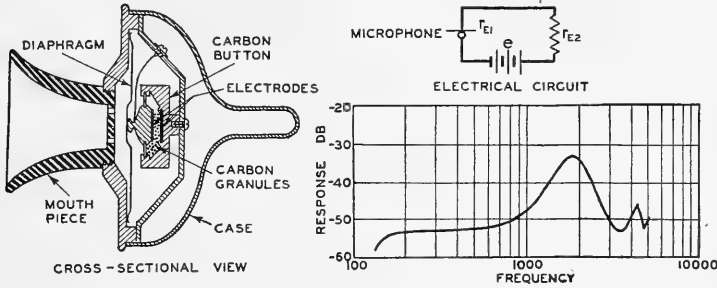

FIG. 9.1. Cross-sectional view and the electrical circuit diagram of a single button carbon microphone. The graph shows the free space open circuit voltage response frequency characteristic.

in the resistance between the diaphragm and the carbon cup. For small displacements the change in resistance is proportional to the displacement. Consider the circuit of Fig. 9.1, for sinusoidal motion of the diaphragm, the current, in amperes, in the circuit is given by

$$i = \frac{e}{r_{E0} + hx \sin \omega t} \tag{9.1}$$

- where  $e$  = voltage of the battery, in volts,
- $r_{E0}$  = total resistance of the circuit when  $x = 0$ , in ohms,
- $x$  = amplitude of the diaphragm, in centimeters,
- $h$  = constant of the carbon element, in ohms per centimeter,
- $\omega = 2\pi f$ , and
- $f$  = frequency, in cycles per second.

Equation 9.1 may be expanded as follows,

$$\begin{aligned} i &= \frac{e}{r_{E0}} \left( 1 - \frac{hx}{r_{E0}} \sin \omega t + \frac{h^2 x^2}{r_{E0}^2} \sin^2 \omega t \dots \right) \\ &= \frac{e}{r_{E0}} \left( 1 - \frac{hx}{r_{E0}} \sin \omega t + \frac{h^2 x^2}{2r_{E0}^2} - \frac{h^2 x^2}{2r_{E0}^2} \cos 2\omega t \dots \right) \end{aligned} \tag{9.2}$$

Equation 9.2 shows that there is a steady current, an alternating current of the frequency of the diaphragm vibration and harmonics of this vibra-

tion. For a limited frequency range of reproduction the nonlinear distortion is not particularly objectionable.

A response frequency characteristic of the microphone shown in Fig. 9.1 is shown by the graph. The diaphragm of this microphone is a circular plate supported at the edge, see Sec. 3.5. Below the fundamental resonance frequency the displacement is proportional to the pressure. Since the change in resistance of the carbon button and the resultant developed voltage is proportional to the displacement, the output will be independent of the frequency below the fundamental resonance frequency. These observations are supported by the response frequency characteristic which

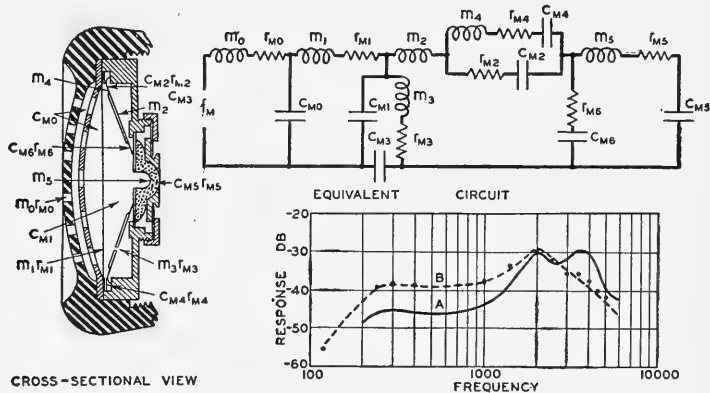

FIG. 9.2. Cross-sectional view and equivalent circuit of an improved single button carbon microphone. The open circuit voltage response characteristics are shown by the graph. *A*. Response in free space. *B*. Response for constant sound pressure on the diaphragm. Dots computed from equivalent circuit. (After Jones.)

depicts uniform response in the low frequency range below the fundamental resonance frequency. In the region of the resonance frequency the output is accentuated. In the range above the resonance frequency the response falls off rapidly with frequency in a series of peaks and dips which indicate vibrations of the diaphragm or plate in the various modes. See Sec. 3.5.

A new type of single carbon button microphone<sup>1</sup> has been developed in which the response is quite uniform over a wide frequency range. (Fig. 9.2.) The conical diaphragm is made of a thin aluminum alloy. At low frequencies the diaphragm vibrates as a single unit. However, at the higher frequencies it is necessary to consider it to be made up of three sepa-

<sup>1</sup> Jones, W. C., *Jour. A.I.E.E.*, Vol. 57, No. 10, p. 559, 1939.

rate masses. These masses consist of the central portion  $m_3$ , the ribbed intermediate portion  $m_2$  and the outer portion  $m_4$ . The central portion includes the mass of the movable electrode and is coupled to the ribbed portion by the compliance  $C_{M6}$  which in turn is coupled to the outer portion by the compliance  $C_{M2}$ . The paper books which support the edge of the diaphragm have a compliance  $C_{M4}$  and a mechanical resistance  $r_{M4}$ . Their mass is included in the outer portion of the diaphragm  $m_4$ . The internal mechanical resistance of the portions which form the coupling compliances  $C_{M2}$  and  $C_{M6}$  are represented by  $r_{M2}$  and  $r_{M6}$  respectively. A hole is provided in the diaphragm to permit rapid equalization of low frequency pressures of high intensity and prevent damage to the diaphragm and other parts. The mass and the mechanical resistance of this hole  $m_3 r_{M3}$  is so chosen that their effects on the response are confined to frequencies below 300 cycles. The controlling compliance  $C_{M3}$  is that of the cavity between the diaphragm and the die cast frame. The carbon granules are represented by a compliance  $C_{M5}$  and a mechanical resistance  $r_{M5}$ . The mass of the carbon granules is lumped with that of the central portion of the diaphragm. The holes in the inner grid are sufficiently large so that there is no reaction upon the response. The holes in the outer grill add the mass  $m_0$  and the mechanical resistance  $r_{M0}$ . These holes are coupled to a moisture proof membrane of mass  $m_1$  and mechanical resistance  $r_{M1}$  by means of the compliance  $C_{M0}$  of the enclosed cavity. The cavity compliance  $C_{M1}$  couples the membrane to the diaphragm.

The response of this microphone computed from the equivalent circuit is shown in Fig. 9.2. The response for constant sound pressure on the diaphragm is also shown in Fig. 9.2. It will be seen that the agreement between the computed and measured characteristics is very good and substantiates this type of analysis. The response is very much smoother than in the case of the plate or disk type of diaphragm.

The free space response shown in Fig. 9.2 indicates the diffraction effect of the microphone as an obstacle in increasing the pressure on the diaphragm. See Sec. 1.11.

In addition to the smoother response the sensitivity of the new unit is higher because of the reduction in mass of the vibrating system. Due to the shape of the carbon chamber the performance of the microphone is less affected by angular position.

2. *Double Button Carbon Microphone.* — For applications requiring both high quality and large power output the single button carbon microphone is not suitable due to the large nonlinear distortion.

To obtain uniform response over a very wide range with very low dis-

tion, a microphone<sup>2</sup> with a stretched diaphragm and two carbon buttons is used (Fig. 9.3). The mechanical impedance of a stretched diaphragm below its resonance frequency is a stiffness mechanical reactance. Therefore, a constant sound pressure on the diaphragm will produce substantially constant displacement. Since the change in resistance of the carbon buttons and the resultant developed voltage is proportional to the displacement, the voltage output will be independent of the frequency. To provide damping at the resonance frequency of the diaphragm the

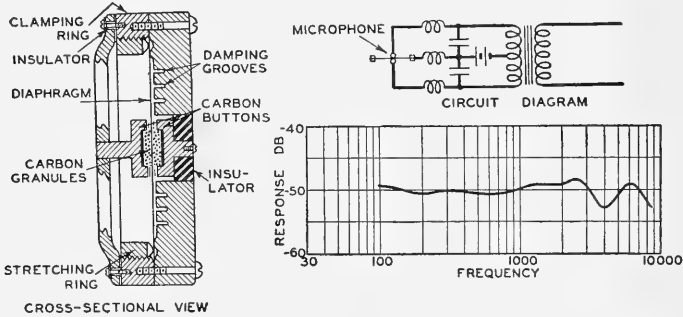

FIG. 9.3. Cross-sectional view and electrical circuit diagram of a double button, stretched diaphragm, carbon microphone. The graph shows the open circuit voltage response frequency characteristic for constant sound pressure on the diaphragm.

damping plate is placed very close to the back of the diaphragm. As the diaphragm moves air is forced through this small space. The high viscosity loss in a small slit provides the damping. See Sec. 5.4. In order to reduce the stiffness, in the small space, suitable grooves are provided which reduce the length of the slit. The rear button is enclosed in the damping plate while the front button is supported by the bridge. The duraluminum diaphragm is gold plated over the area occupied by the carbon buttons to insure contact between the carbon granules and the diaphragm. The resonance frequency of the stretched diaphragm is usually placed between 5000 and 8000 cycles. See Sec. 3.4. In the absence of the damping plate the amplitude for a constant force at the resonance frequency would be greater than that below the resonance frequency. By means of the damping plate the amplitude at the resonance frequency can be reduced to correspond to that of the remainder of the range. A response frequency characteristic of this microphone is shown in Fig. 9.3.

The circuit diagram for this microphone is shown in Fig. 9.3. For a

<sup>2</sup> Jones, W. C., *Bell Syst. Tech. Jour.*, Vol. 10, No. 1, p. 46, 1931.

sinusoidal motion of the diaphragm the current, in amperes, in one of the buttons may be written as

$$i_1 = \frac{e}{r_{E0} + hx \sin \omega t} \quad 9.3$$

when  $e$  = voltage of the battery, in volts,  
 $r_{E0}$  = resistance of the circuit, when  $x = 0$ , in ohms,  
 $x$  = amplitude of the diaphragm, in centimeters,  
 $h$  = constant of the carbon element, in ohms per centimeter,  
 $\omega = 2\pi f$ , and  
 $f$  = frequency, in cycles per second.

The current in the other button is

$$i_2 = \frac{e}{r_{E0} - hx \sin \omega t} \quad 9.4$$

The difference of equations 9.3 and 9.4 after expanding is,

$$\begin{aligned} i_2 - i_1 &= \frac{2e}{r_{E0}} \left( \frac{hx}{r_{E0}} \sin \omega t + \frac{h^3 x^3}{r_{E0}^3} \sin^3 \omega t \dots \right) \\ &= \frac{2e}{r_{E0}} \left( \frac{hx \sin \omega t}{r_{E0}} + \frac{3}{4} \frac{h^3 x^3}{r_{E0}^3} \sin \omega t - \frac{h^3 x^3}{4r_{E0}^3} \sin 3\omega t \dots \right) \quad 9.5 \end{aligned}$$

Comparing equation 9.5 with equation 9.2 shows that the large second harmonic term has been eliminated by the use of a push-pull two button microphone.

One common cause of faulty operation of the carbon microphone is due to the cohering of the carbon granules caused by the breaking of the circuit when the current is flowing. The use of electric filters as shown in the circuit diagram will protect the microphone against cohering.

The frequency range and response of the double button carbon microphone compares favorably with the condenser microphone. The carbon microphone is several times more sensitive than the condenser microphone. However, the limitation is carbon noise.

**B. Condenser Microphone.** — A condenser microphone is a microphone which depends for its operation on variations in capacitance. The typical condenser microphone<sup>3, 3A</sup> consists of a thin stretched plate separated from a

<sup>3</sup> Wente, E. C., *Phys. Rev.*, Vol. 10, No. 1, p. 39, 1917.

<sup>3A</sup> Olson and Massa, "Applied Acoustics," P. Blakiston's Son and Co., Philadelphia.

parallel rigid plate. The electrical circuit of this microphone is shown in Fig. 9.4.

The capacity, in statfarads, at any instant is given by

$$C_E = C_{E0} + C_{E1} \sin \omega t \tag{9.6}$$

where  $C_{E0}$  = capacity in the absence of an applied pressure, in statfarads,  
 $C_{E1}$  = maximum change in the capacity due to the external applied sinusoidal pressure, in statfarads,

$$\omega = 2\pi f, \text{ and}$$

$$f = \text{frequency, in cycles per second.}$$

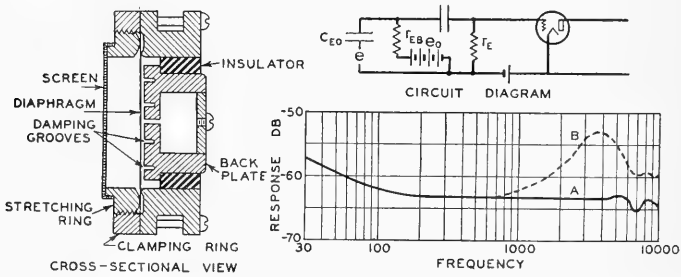

FIG. 9.4. Cross-sectional view of a condenser microphone. The electrical circuit shows the microphone connected to a vacuum tube. The graph shows the open circuit voltage response frequency characteristics. *B*. Response in free space. *A*. Response for constant sound pressure on the diaphragm.

From the electrical circuit

$$e_0 - r_E i = \frac{1}{C_E} \int i dt \tag{9.7}$$

where  $e_0$  = polarizing voltage, in statvolts,

$r_E$  = resistance of the bias resistor, in statohms,

$i$  = current, in statamperes, and

$t$  = time, in seconds.

Equation 9.7 assumes that the bias resistor  $r_{EB}$  and the input impedance of the vacuum tube is very large compared with  $r_E$ . Then  $e_0$  may be considered to be in series with  $C_{E0}$  and  $r_E$ . Substituting the value of  $C_E$  from equation 9.7 in equation 9.6 and differentiating

$$(C_{E0} + C_{E1} \sin \omega t) r_E \frac{di}{dt} + (1 + r_E C_{E1} \omega \cos \omega t) i - e_0 C_{E1} \omega \cos \omega t = 0 \tag{9.8}$$

The solution of equation 9.8 is

$$\begin{aligned}
 i &= \frac{e_0 C_{E1}}{C_{E0} \sqrt{(1/C_{E0}\omega)^2 + r_E^2}} \sin(\omega t + \phi_1) \\
 &\quad - \frac{e_0 C_{E1} r_E}{C_{E0}^2 \sqrt{[(1/C_{E0}\omega)^2 + 4r_E^2][(1/C_{E0}\omega)^2 + r_E^2]}} \sin(2\omega t + \phi_1 - \phi_2) \\
 &\quad + \text{terms of higher order}
 \end{aligned} \tag{9.9}$$

where  $\phi_1 = \tan^{-1} 1/C_{E0}\omega r_E$  and  $\phi_2 = \tan^{-1} 1/2C_{E0}\omega r_E$ .

For small diaphragm amplitudes, the generated voltage, in statvolts, is

$$e' = r_E i = \frac{e_0 C_{E1} r_0}{C_{E0} \sqrt{\frac{1}{C_{E0}^2 \omega^2} + r_0^2}} \sin(\omega t + \phi_1) \tag{9.10}$$

Equation 9.10 shows that the condenser microphone<sup>4</sup> may be considered as a generator with an internal open circuit voltage of

$$e = e_0 \left( \frac{C_{E1}}{C_{E0}} \right) \sin(\omega t + \phi_1), \text{ in statvolts,} \tag{9.11}$$

and an internal impedance of  $1/C_{E0}\omega$ , in statohms.

Equation 9.11 shows that the voltage is proportional to the amplitude. Therefore, to obtain a microphone in which the sensitivity is independent of the frequency the amplitude for a constant applied pressure must be independent of the frequency. In the range below the resonance frequency the amplitude of a stretched membrane for a constant applied force is independent of the frequency. See Sec. 3.4. The addition of the back plate with very close spacing introduces mechanical resistance<sup>5,6</sup> due to the viscosity loss in the narrow slit. See Sec. 5.4. This mechanical resistance reduces the amplitude at the resonance frequency. The back plate also introduces stiffness due to the entrapped air. This stiffness can be reduced without reducing the mechanical resistance by cutting grooves in the back of the plate. If the damping is made sufficiently large the amplitude at the fundamental resonance frequency of the diaphragm can be made to correspond to that of the remainder of the range.

<sup>4</sup> Wente, E. C., *Phys. Rev.*, Vol. 10, No. 5, p. 498, 1922.

<sup>5</sup> Crandall, I. B., *Phys. Rev.*, Vol. 11, No. 6, p. 449, 1918.

<sup>6</sup> Crandall, "Vibrating Systems and Sound," p. 28, D. Van Nostrand Co., New York.

The amplitude of the diaphragm is given by

$$x = \frac{f_M}{r_M + j\omega m - \frac{j}{\omega C_{M1}} - \frac{j}{\omega C_{M2}}} \quad 9.12$$

where  $f_M$  = applied force, in dynes,

$r_M$  = damping mechanical resistance of air film, in mechanical ohms,

$m$  = effective mass of the diaphragm, in grams,

$C_{M1}$  = compliance due to stiffness of the diaphragm, in centimeters per dyne,

$C_{M2}$  = compliance due to stiffness of the air film, in centimeters per dyne,

$\omega = 2\pi f$ , and

$f$  = frequency, in cycles per second.

Equation 9.12 shows that the sensitivity below the resonance frequency is inversely proportional to the stiffness and the mechanical resistance. For the same fundamental resonance frequency the stiffness can be reduced by decreasing the mass. This procedure also reduces the amount of mechanical resistance required to damp the fundamental resonance and thereby obtain uniform response. Aluminum alloys, due to the low density and high tensile strength, are the logical materials for use in diaphragms. The minimum diaphragm thickness suitable for the manufacture of condenser microphones is about .001 inch. The capacity of a microphone with a diaphragm diameter of  $1\frac{5}{8}$  inches and a spacing of from .001 to .002 inch is from 400 to 200 mmfds. Due to the high impedance of this capacitance it is necessary to locate the microphone near the vacuum tube amplifier. The capacitance of a long connecting cable reduces the sensitivity without frequency discrimination because the internal impedance of the microphone is also a capacitance. The response frequency characteristics of a condenser microphone for constant sound pressure on the diaphragm and for constant free wave sound pressure are shown in Fig. 9.4.

*C. Piezoelectric (Crystal) Microphones*<sup>7,8,9,9A</sup>. — A piezoelectric microphone is a microphone which depends upon the generation of an electro-

<sup>7</sup> Sawyer, C. B., *Proc. Inst. Rad. Eng.*, Vol. 19, No. 11, p. 2020, 1931.

<sup>8</sup> Williams, A. L., *Jour. Soc. Mot. Pic. Eng.*, Vol. 18, No. 4, p. 196, 1934.

<sup>9</sup> Nicolson, U. S. Patent 1,495,429.

<sup>9A</sup> Olson and Massa, "Applied Acoustics," P. Blakiston's Son and Co., Philadelphia.



motive force by the deformation of a crystal having piezoelectric properties. Section 6.5 considered the piezoelectric crystal as a driver. In the case of the microphone the reverse effect is used. The voltage generated due to a deformation of the crystal is proportional to the displacement. Therefore, to obtain a uniformly sensitive microphone with respect to frequency the displacement for a constant applied force must be independent of the frequency. Rochelle salt exhibits the greatest piezoelectric activity of all of the known crystals. For this reason it is used in audio frequency microphones. There are two general classifications of crystal microphones, namely: the direct actuated and the diaphragm actuated. In the direct

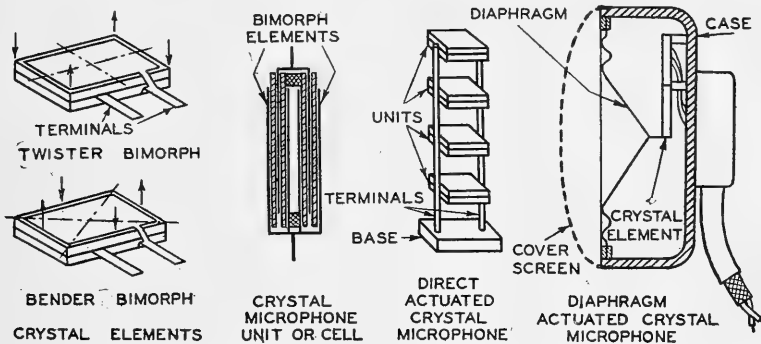

Fig. 9.5. Crystal elements and sound cells. A direct actuated crystal microphone. A cross-sectional view of a diaphragm actuated crystal microphone.

actuated the sound pressure acts directly upon the crystal. In the diaphragm actuated the sound pressure acts upon a diaphragm which is coupled to a crystal. The crystal element, Fig. 9.5, is made up of two crystals cut so that a voltage is generated when forces are applied as shown. The two types of bimorph elements, namely, "twisters" and "benders," are shown in Fig. 9.5. The advantages of a bimorph construction over the single crystal are as follows: it lends itself to a more efficient size and shape; it becomes more sensitive (a gain of 15 times for practical shapes); it reduces the variations of the mechanical and electrical constants of the crystal for changes in temperature. The temperature limits of bimorph crystals are from  $-40^{\circ}\text{F}$ . to  $130^{\circ}\text{F}$ . If exposed to temperatures in excess of  $130^{\circ}\text{F}$ . the crystal loses its piezoelectric activity permanently. The sensitivity or voltage output of the crystal varies with temperature due primarily to a change in the capacitance and in a lesser degree to a change in the developed voltage.

1. *Direct Actuated Crystal Microphone.* — In the direct actuated crystal microphone the sound pressure acts directly upon the crystal. A common form of sound cell for a direct actuated crystal microphone consists of two bimorph elements assembled as shown in Fig. 9.5. The cavity formed by the two crystal elements is completely enclosed so that the application of an external pressure causes a deformation of the crystal.

The internal voltage  $e$  developed by the crystal is

$$e = Kx \quad 9.13$$

where  $K$  = constant of the crystal, and

$x$  = effective amplitude of the deformation of the crystal by an applied force.

The effective periodic force,  $f_M$ , required to produce a periodic displacement,  $x$ , in the crystal is

$$f_M = \frac{x}{C_M} \quad 9.14$$

where  $C_M$  = the effective compliance of the crystal.

The force acting in the case of the directly actuated crystal is

$$f_M = pA \quad 9.15$$

where  $p$  = sound pressure, and

$A$  = effective area of the crystal.

From equations 9.13, 9.14 and 9.15 the generated voltage is

$$e = KC_MAp \quad 9.16$$

Equation 9.16 shows that the internal voltage generated by the microphone is in phase with the sound pressure in the sound wave. A typical direct actuated microphone shown in Fig. 9.5 consists of four sound cells. The use of several cells in parallel reduces the high internal impedance as compared to that of the single cell. The response characteristic of sound cells can be varied in design so that uniform response can be obtained up to 17,000 cycles. In the case of a small crystal element and an open structure the system is nondirectional.

2. *Diaphragm Actuated Crystal Microphone.* — In the diaphragm actuated crystal microphone the sound pressure acts upon a diaphragm which in turn drives a crystal. The output of the diaphragm actuated type is considerably higher than the direct actuated type because the diaphragm acts as a coupling unit between the relatively low impedance of the air and

the high impedance of the crystal. A cross-sectional view of a diaphragm actuated crystal microphone is shown in Fig. 9.5.

D. *Moving Conductor Microphones.* — A moving coil microphone is a microphone in which the output results from the motion of a conductor in a magnetic field. The conductor may be in the form of a circular coil which is termed a moving coil microphone or in the form of a straight conductor which is termed an inductor microphone. These microphones are also termed dynamic microphones.

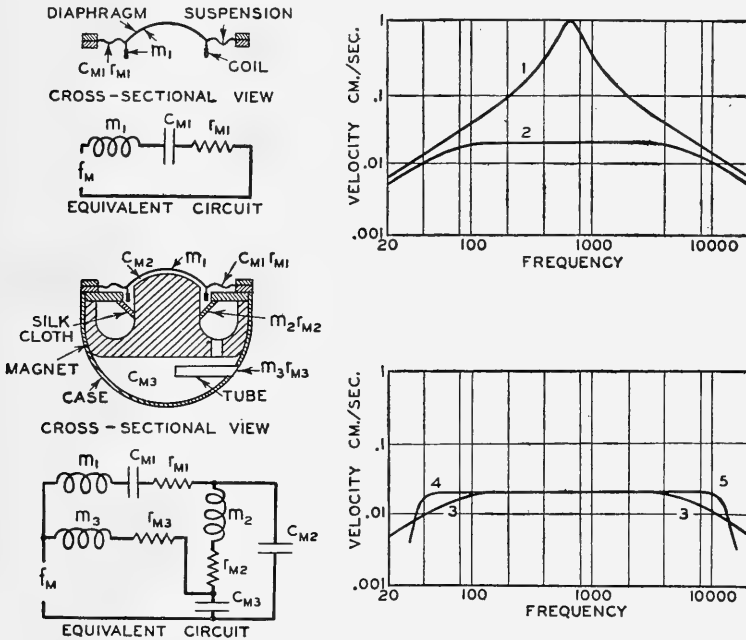

FIG. 9.6. Cross-sectional view and equivalent circuit of a diaphragm, coil and suspension is shown above. The velocity frequency characteristic for a unit force and a unit resistance is indicated as Curve 1 on the graph. The same for a resistance of 60 units is indicated as Curve 2. Cross-sectional view and equivalent circuit of a dynamic microphone is shown below. Curve 3 on the lower graph is the same as Curve 2 on the upper graph. Curve 4 is the response with the tube  $m_3 r_3$  added. Curve 5 is the response with the compliance  $C_{M2}$  added.

1. *Moving Coil Microphone (Dynamic Microphone)*<sup>10</sup>. — A cross-sectional view of a moving coil microphone is shown in Fig. 9.6. The motion of the diaphragm is transferred to a coil located in a magnetic field.

<sup>10</sup> Wentz and Thurax, *Jour. Acous. Soc. Amer.*, Vol. 3, No. 1, p. 44, 1931.

The equivalent circuit of the mechanical system consisting of the diaphragm coil and suspension system is shown in Fig. 9.6.

The velocity, in centimeters per second, of the voice coil is given by

$$\dot{x} = \frac{f_M}{r_{M1} + j\omega m_1 + \frac{1}{j\omega C_{M1}}} \quad 9.17$$

where  $r_{M1}$  = mechanical resistance of the suspension system, in mechanical ohms,

$m_1$  = mass of the diaphragm and voice coil, in grams, and

$C_{M1}$  = compliance of the suspension system, in centimeters per dyne.

The generated internal voltage, in abvolts, is

$$e = Bl\dot{x} \quad 9.18$$

where  $B$  = flux density in the air gap, in gaussses,

$l$  = length of the voice coil conductor, in centimeters, and

$\dot{x}$  = velocity of the voice coil, in centimeters.

Equation 9.18 shows that the microphone will be uniformly sensitive with respect to frequency if the velocity is independent of the frequency. The characteristics 1 and 2 in Fig. 9.6 were computed by employing equation 9.17. These characteristics show that a uniformly sensitive dynamic microphone, with respect to frequency, must be essentially "resistance controlled."

The characteristic marked 2 shows some falling off in velocity at the high and low frequencies. This can be corrected by the use of some additional elements. The major portion of the resistance is the silk cloth  $m_2 r_{M2}$ . Resistance in the case of silk cloth is due to the high viscosity introduced by the small holes. See Sec. 5.3. Slits have also been used for the resistance element. See Sec. 5.4. The mass reactance of the diaphragm is reduced at the higher frequencies by the compliance  $C_{M2}$  formed by the volume between the silk and the diaphragm. The addition of the elements  $C_{M2}$ ,  $r_{M2}$  and  $m_2$  changes the characteristic at the high frequencies from that marked 3 to that marked 5. An increase in response over an octave is obtained by the addition of these elements. A corresponding increase in response can be obtained at the low frequencies by means of the case volume  $C_{M3}$  and the addition of a tube  $m_3 r_{M3}$ . The equivalent circuit shows the action of the additional elements in changing the response from the characteristic 3 to the characteristic 4-5.

The most common materials used for the diaphragms of pressure micro-

phones are aluminum alloys, Bakelite, styrol and paper. In order to obtain a maximum ratio of conductivity to mass, aluminum is almost universally used for the voice coil. Both edgewise wound ribbon and round wire have been used for the voice coil. See Fig. 7.18.

The diffraction of sound as a function of the angle of the incident sound by various objects shows that the sphere exhibits the most uniform directional pattern (Fig. 1.5). A spherical case with the diaphragm located on the surface of the sphere seems to be the logical starting point for a non-directional pressure microphone. Referring again to Fig. 1.5, it will be seen that the microphone will show excess response over the range from  $0^\circ$  to  $60^\circ$  and will be lacking in response from  $120^\circ$  to  $160^\circ$ . This non-uniform response can be corrected by placing a disk, of semi-transmitting characteristics, of diameter equal to the spherical case directly above the diaphragm and spaced one-fourth inch. Employing this expedient, a non-directional characteristic<sup>11</sup> is obtained for all frequencies.

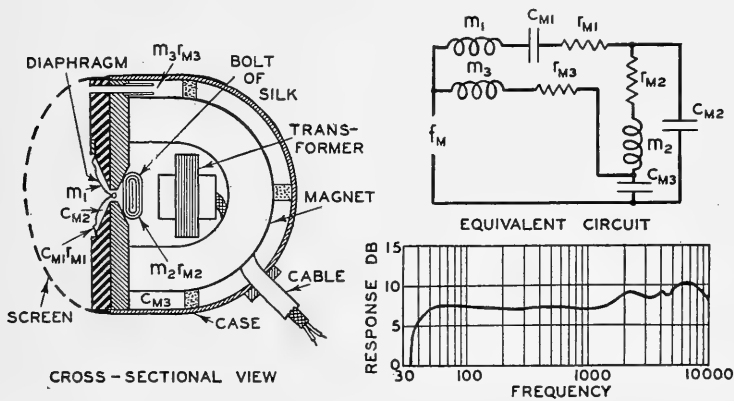

FIG. 9.7. Cross-sectional view and the equivalent circuit of an inductor microphone. The graph shows the free space open circuit voltage response frequency characteristic.

2. *Inductor Microphone*<sup>12</sup> (*Straight Line Conductor*). — The inductor microphone is another example of a moving conductor microphone. A cross-sectional view of this microphone is shown in Fig. 9.7. The diaphragm  $r_{M1}C_{M1}m_1$  of this microphone is “V” shaped with a straight conductor located in the bottom of the “V.” The equivalent circuit of this microphone is the same as that of the dynamic microphone in the preceding

<sup>11</sup> Marshall and Romanow, *Bell Syst. Tech. Jour.*, Vol. 15, No. 3, p. 405, 1936.  
<sup>12</sup> Olson, H. F., U. S. Patent 2,106,224.

section and the action is the same. A transformer housed in the magnet structure is used to step up the low impedance of the conductor to that suitable for transmission over a line of several hundred feet.

3. *Ribbon Type.* — The pressure ribbon microphone<sup>13,14,14A</sup> consists of a light metallic ribbon suspended in a magnetic field and freely accessible to the atmosphere on one side and terminated in an acoustic resistance on the

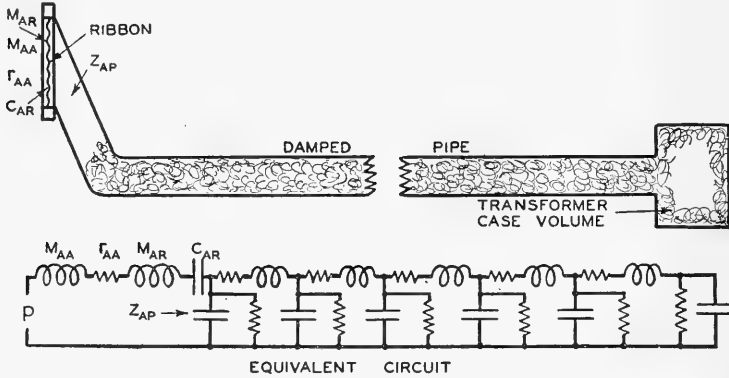

FIG. 9.8. The elements of the pressure microphone and the equivalent electrical circuit of the acoustical system.  $M_{AR}$  inertance of the ribbon.  $C_{AR}$  acoustic capacitance of the ribbon.  $r_{AA}$  acoustic resistance of the air load on the ribbon.  $M_{AA}$  inertance of the air load upon the ribbon.  $Z_{AP}$  acoustic impedance of the pipe terminating the ribbon.  $p$  driving sound pressure.

other side. The essential elements are shown schematically in Fig. 9.8. These elements may take various forms as, for example, the pipe is usually coiled in the form of a labyrinth. See Fig. 9.24.

The equivalent circuit<sup>15</sup> of the pressure ribbon microphone is shown in Fig. 9.8.

The inertance and acoustic capacitance of the ribbon is given by  $M_{AR}$  and  $C_{AR}$ .

The resistance and mass of the air load upon the ribbon are designated by  $r_{AA}$  and  $M_{AA}$ . The expression for the air load upon the ribbon will now be derived. The pressure, in dynes per square centimeter, at a distance

<sup>13</sup> Olson, H. F., U. S. Patent 2,102,736.

<sup>14</sup> Olson, H. F., *Four. Soc. Mot. Pic. Eng.*, Vol. 27, No. 3, p. 284, 1936.

<sup>14A</sup> Olson and Massa, "Applied Acoustics," P. Blakiston's Son and Co., Philadelphia.

<sup>15</sup> Olson, H. F., *Broadcast News*, No. 30, p. 3, May, 1939.

$a$  in centimeters, from an elementary source is (see Sec. 2.2)

$$p = \frac{dS}{4\pi a} j\rho\omega u_{\max} \epsilon^{j\omega t} \epsilon^{-jka} \quad 9.19$$

where  $dS$  = area of the source, in square centimeters,

$u_{\max}$  = maximum velocity of  $dS$ , in centimeters per second,

$\rho$  = density of air, in grams per cubic centimeter,

$\omega = 2\pi f$ ,

$f$  = frequency, in cycles per second,

$u$  = velocity over the surface  $dS$ , in centimeters per second,

$t$  = time, in seconds,

$k = 2\pi/\lambda$ , and

$\lambda$  = wavelength, in centimeters.

The pressure at any point on the ribbon due to a velocity  $u_{\max} \epsilon^{j\omega t}$  of the ribbon is

$$p = \frac{j\omega\rho}{4\pi} u_{\max} \epsilon^{j\omega t} \iint \frac{dS}{a_1} \epsilon^{-jka_1} \quad 9.20$$

where  $a_1$  = radius vector having the shortest air distance from the point 1 to the surface element  $dS$ . To compute the total force, the above integration must be performed and then the resulting pressure integrated over the surface of the ribbon.

The total force is

$$f_{MA} = \frac{j\omega\rho u_{\max} \epsilon^{j\omega t}}{4\pi} \iint dS' \iint \frac{dS}{a_1} \epsilon^{jka_1} \quad 9.21$$

where  $dS'$  = surface element at 1.

The acoustic impedance is

$$z_{AA} = r_{AA} + jx_{AA} = \frac{f_{MA}}{A^2 u_{\max} \epsilon^{j\omega t}} \quad 9.22$$

The ribbon is spaced from the pole pieces of the magnetic structure to allow freedom of motion. This slit or aperture  $r_{AS}$  and  $M_{AS}$  gives rise to an impedance (see Sec. 5.4).

$$z_{AS} = r_{AS} + j\omega M_{AS} \quad 9.23$$

where  $r_{AS}$  = acoustic resistance of the slit, in acoustic ohms, and

$M_{AS}$  = inertance of the slit, in grams per (centimeter).<sup>4</sup>

The back of the ribbon is terminated in an acoustic resistance in the form of a finite pipe damped with tufts of felt. The equivalent circuit of the

pipe shows that for the mid and high frequency range the impedance is an acoustic resistance.

The acoustic resistance of the pipe referred to the ribbon is,

$$r_{AP} = \frac{42}{A_P} \quad 9.24$$

where  $A_P$  = area of the pipe, in square centimeters.

The acoustic impedance due to the electrical circuit may influence the motion of the ribbon. The acoustical impedance due to the electrical circuit is

$$z_{AE} = \frac{(Bl)^2}{A_R^2 z_T} \quad 9.25$$

where  $z_T$  = total electrical impedance in the ribbon circuit, in abohms, and  $A_R$  = area of the ribbon, in square centimeters.

The acoustic impedance  $z_{AB}$ , due to the electrical circuit, and the acoustic impedance  $z_{AS}$ , due to the aperture between the ribbon and pole pieces, are in general small compared to the other impedances in the system save at the very low frequencies.

The acoustic impedance characteristics of the elements of a pressure ribbon microphone are shown in Fig. 9.9.

The volume current of the ribbon, in cubic centimeters per second, is given by

$$U = \frac{p}{r_{AP} + r_{AA} + jX_{AR} + jX_{AA} - jX_{AP}} \quad 9.26$$

The volume current of the ribbon and the phase angle between the volume current and pressure computed from equation 9.26 is shown in Fig. 9.9.

The velocity of the ribbon, in centimeters per second, is

$$\dot{x} = \frac{U}{A_R} \quad 9.27$$

The voltage, in abvolts, generated in the ribbon is given

$$e = Bl\dot{x} \quad 9.28$$

where  $B$  = flux density, in gaussses, and

$l$  = length of the ribbon, in centimeters.

The shape of the voltage curve will be the same as that of  $U_V$  in Fig. 9.9. This assumes that the pressure is the same for all frequencies. However,



due to the obstacle effect, see Sec. 1.11, the pressure on the ribbon increases at the higher frequencies and the output is practically independent of the frequency.

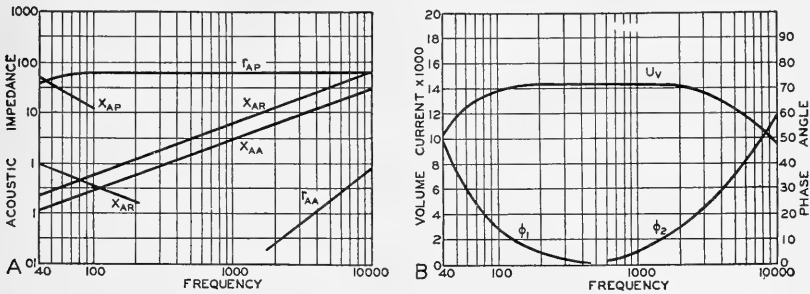

FIG. 9.9. *A.* The impedance characteristics of the elements of the pressure microphone.  $x_{AR}$  ribbon acoustic reactance.  $x_{AA}$  air load acoustic reactance.  $r_{AA}$  air load acoustic resistance.  $x_{AP}$  pipe acoustic reactance (negative).  $r_{AP}$  pipe acoustic resistance. *B.* The volume current  $U_V$  of the pressure ribbon for a sound pressure of one dyne per square centimeter.  $\phi$  phase angle between the ribbon velocity and the driving pressure.  $\phi_1$  leading,  $\phi_2$  lagging.

**9.3. Velocity Microphones.** — A pressure gradient microphone is a microphone in which the electrical response corresponds to the difference in pressure between two points in space. In general, when the distance between these two points is small compared to the wavelength, the pressure gradient corresponds to the particle velocity. A velocity microphone is a microphone in which the electrical response corresponds to the particle velocity resulting from the propagation of a sound wave through an acoustic medium. The acoustical and electrical elements which form the coupling means, between the atmosphere and the electrical system, for transforming the sound vibrations into the corresponding electrical variations may be arranged in innumerable ways to obtain pressure gradient or velocity microphones. It is the purpose of this section to consider pressure gradient and velocity microphones.

*A. Pressure Gradient Microphone*<sup>16,17,18,19,19A</sup>. — The response of a pressure gradient microphone, as the name implies, is a function of the difference in sound pressure between two points. Obviously, a pressure gradient microphone may be built in a number of ways. One type of pressure

<sup>16</sup> Olson, H. F., *Jour. Soc. Mot. Pic. Eng.*, Vol. 16, No. 6, p. 695, 1931.

<sup>17</sup> Olson, H. F., *Jour. Acous. Soc. Amer.*, Vol. 3, No. 1, p. 56, 1931.

<sup>18</sup> Olson, H. F., *Proc. Inst. Rad. Eng.*, Vol. 21, No. 5, p. 655, 1933.

<sup>19</sup> Massa, F., *Jour. Acous. Soc. Amer.*, Vol. 10, No. 3, p. 173, 1939.

<sup>19A</sup> Olson and Massa, "Applied Acoustics," P. Blakiston's Son and Co., Philadelphia.

gradient microphone consists of two pressure actuated units, separated by a very small distance, with the electrical outputs connected in opposition. Figure 9.10 schematically depicts the essential elements of a pressure gradient microphone.

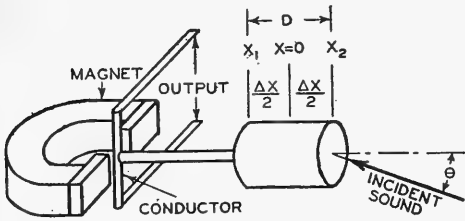

FIG. 9.10. Pressure gradient microphone.

A cylinder of mass  $m$  is coupled to a conductor located in a magnetic field. The cylinder is assumed to be the only portion of the system which will be influenced by sound waves. The diameter of the cylinder is assumed to be small compared to the wavelength. Therefore,

the average intensity will be the same for all points on the surface of the cylinder. The vibrating system is assumed to be constrained so that the only motion possible is one in a direction parallel to the longitudinal axis of the cylinder. Under these conditions the vibrating system is driven by the difference between the forces on the two ends of the cylinder due to the impinging sound wave.

Assume a plane sound wave, from equation 1.22, the pressure, in dynes per square centimeter, at  $x = 0$  may be written

$$\begin{aligned} p &= kc\rho A \sin(kct) \\ p &= p_m \sin kct \end{aligned} \tag{9.29}$$

where  $c$  = velocity of sound, in centimeters per second,

$$k = 2\pi/\lambda,$$

$\lambda$  = wavelength, in centimeters,

$\rho$  = density, in grams per cubic centimeter,

$A$  = amplitude of  $\phi$ ,

$\phi$  = velocity potential, and

$p_m$  = maximum sound pressure, in dynes per square centimeter.

The pressure at the end of the cylinder  $x_1 = -\Delta x/2$  for a direction of propagation  $\theta$  is

$$p_1 = p_m \sin k \left( ct + \frac{\Delta x}{2} \cos \theta \right) \tag{9.30}$$

The pressure at the other end of the cylinder  $x_2 = \Delta x/2$  is

$$p_2 = p_m \sin k \left( ct - \frac{\Delta x}{2} \cos \theta \right) \tag{9.31}$$

The difference in pressure between the two ends of the cylinder is

$$\Delta p = p_1 - p_2 = 2p_m \cos(ckt) \sin\left(\frac{k\Delta x}{2} \cos \theta\right) \quad 9.32$$

The driving force, in dynes, available for driving the cylinder along the  $x$  axis is

$$f_M = S\Delta p = 2Sp_m \cos(ckt) \sin\left(\frac{k\Delta x}{2} \cos \theta\right) \quad 9.33$$

where  $S$  = area of the end of the cylinder, in square centimeters.

If  $\Delta x$  is small compared to the wavelength the driving force is

$$f_M = S \frac{2\pi f}{c} p_m \Delta x \cos \theta \cos kct \quad 9.34$$

A comparison of equations 9.29 and 9.34 shows that for a wave of constant sound pressure the driving force is proportional to the frequency.

The velocity of the mechanical system for  $\Delta x$  small compared to the wavelength is

$$\dot{x} = \frac{f_M}{j\omega m} = \frac{Sp_m}{jcm} \Delta x \cos \theta \cos kct = \frac{Sp_m}{cm} \Delta x \cos \theta \sin kct \quad 9.35$$

where  $m$  = mass of the cylinder, in grams, and

$$\omega = 2\pi f, f = \text{frequency, in cycles per second.}$$

This quantity is independent of the frequency and as a consequence the ratio of the generated voltage to the pressure in the sound wave will be independent of the frequency.

The velocity of the mechanical system for any value of  $\Delta x$  is

$$\dot{x} = \frac{2Sp_m}{cm\omega} \sin(ckt) \sin\left(\frac{k\Delta x}{2} \cos \theta\right) \quad 9.36$$

$$\dot{x} = \frac{2Sp_m}{cm\omega} \sin(ckt) \sin\left(\frac{kD}{2} \cos \theta\right) \quad 9.37$$

where  $D$  = distance between the two ends of the cylinder.

The voltage output, in abvolts, of the conductor is

$$e = Bl\dot{x} \quad 9.38$$

where  $B$  = flux density in the field in which the conductor moves, in  
gausses,

$l$  = length of the conductor, in centimeters, and

$\dot{x}$  = velocity of the conductor, in centimeters per second.

The response frequency characteristic of a mass controlled, dynamic pressure gradient microphone computed from equations 9.37 and 9.38 is shown in Fig. 9.11.

The directional characteristics of a pressure gradient system of the type shown in Fig. 9.10 and computed from equation 9.37 are shown in Fig. 9.12. It will be seen that when the ratio  $D$  is greater than  $\lambda/4$  the directional pattern becomes progressively broader as the frequency increases. In the case of the baffle type ribbon microphone, the directional characteristics first become sharper than the cosine pattern and then broader as the dimensions become comparable to the wavelength. In other words, the doublet theory is not in accord with the observed results. Of course, deviations would be expected when the dimensions of the baffle become comparable to the wavelength because of variations in both intensity and phase due to changes in the diffraction of sound by the baffle.

The above considerations have been concerned with a plane wave. From equation 1.40 the pressure component in a spherical wave is

$$p = \frac{k\rho A}{r} \sin k(ct - r) \quad 9.39$$

Let the distance on the axis of the cylinder between the source and points  $x_2$  and  $x_1$  on the cylinder be  $r - \Delta x/2$  and  $r + \Delta x/2$  (Fig. 9.10). The difference in pressure between the two ends of the cylinder is

$$\Delta p = k\rho A \left[ \frac{2r \cos k(ct - r) \sin\left(\frac{kD}{2}\right) + 2D \sin k(ct - r) \cos\left(\frac{kD}{2}\right)}{r^2 - \left(\frac{D}{2}\right)^2} \right] \quad 9.40$$

If  $D$  is small compared to  $r$  and  $kD$  is small compared to unity equation 9.40 becomes approximately

$$\Delta p = k\rho AD \left[ \frac{kr \cos k(ct - r) + \sin k(ct - r)}{r^2} \right] \quad 9.41$$

This equation is similar to equation 1.42 for the particle velocity in a sound wave. Therefore, the voltage output of this microphone corresponds

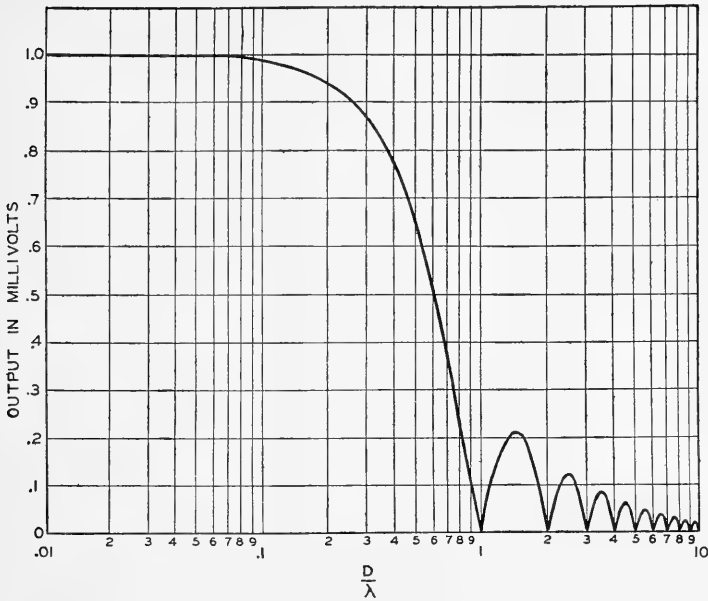

FIG. 9.11. Computed open circuit voltage response frequency characteristic of a pressure gradient, mass controlled, electrodynamic microphone.

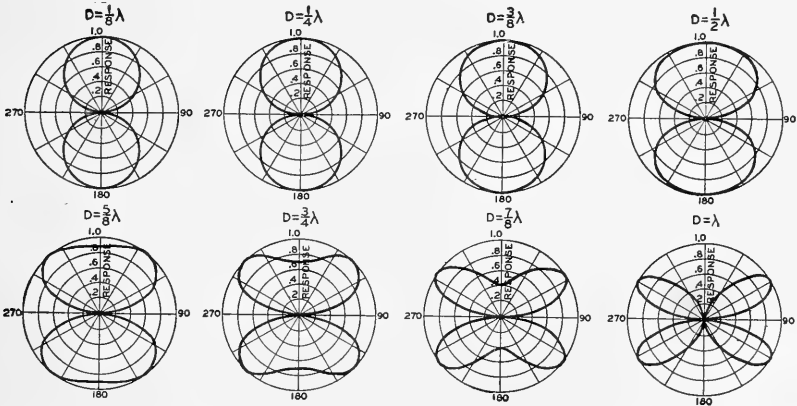

FIG. 9.12. Directional characteristics of a pressure gradient microphone as a function of the dimensions and the wavelength. The polar graph depicts the output, in volts, as a function of the angle, in degrees. The maximum response is arbitrarily chosen as unity.

to the particle velocity in a sound wave. The response of a pressure gradient microphone as a function of the distance from a point source and the frequency is shown in Fig. 9.26*A*.

B. *Velocity Microphone*<sup>20,21,22</sup>. — During the past few years free ribbon microphones have been used for all types of sound collection. Essentially these microphones consist of a loosely stretched ribbon suspended in the air gap between two pole pieces (Fig. 9.13). In addition to supplying the flux to the air gap the pole pieces serve as a baffle for acoustically separating the two sides of the ribbon. The configuration and dimensions of the baffle determine the effective sound path between the two sides of the ribbon. Under the influence of a sound wave the ribbon is driven from its equilibrium position by the difference in pressure between the two sides. The motion of the ribbon in the magnetic field induces a voltage between the two ends of the ribbon. The electrical output of this system under certain conditions corresponds to the particle velocity in a sound wave. Accordingly, the term velocity microphone has been applied to the free ribbon microphone. In

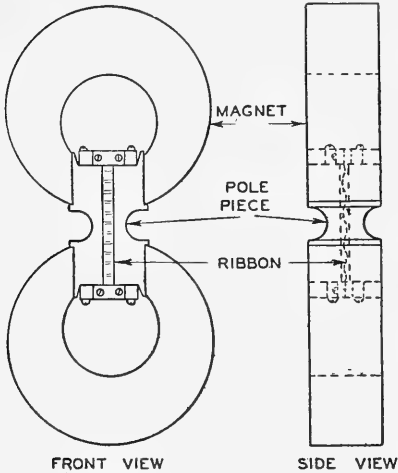

FIG. 9.13. The essential elements of a velocity microphone.

past analysis it has been customary to treat the system as an acoustic doublet. This method is essentially accurate when the effective dimensions of the baffle are small compared to the wavelength. When the effective dimensions are comparable to the wavelength, there is considerable discrepancy between the simple doublet theory and the actual performance. It is the purpose of this section to develop the theory of the conventional baffle type velocity microphone.

Approximate solutions for the diffraction of sound by a circular and square plate have been obtained.<sup>23</sup> These analyses may be applied to the problem of the baffle type ribbon microphone.

<sup>20</sup> Olson, H. F., *Jour. Soc. Mot. Pic. Eng.*, Vol. 16, No. 6, p. 695, 1931.

<sup>21</sup> Olson, H. F., *Jour. Acous. Soc. Amer.*, Vol. 3, No. 1, p. 56, 1931.

<sup>22</sup> Olson, H. F., *Proc. Inst. Rad. Eng.*, Vol. 21, No. 5, p. 655, 1933.

<sup>23</sup> Sivian and O'Neil, *Jour. Acous. Soc. Amer.*, Vol. 3, No. 4, p. 483, 1932.

The ratio of the pressure at the center of a circular plate for any angle of the incident sound is

$$\frac{p_\theta}{p} = 1 + \frac{\cos \theta}{\sqrt{1 - \sin^2 \theta}} \left[ 1 - \epsilon^{jkR} \sum_{u=0}^{\infty} \epsilon_u j^u \mu^u J_u(kR \sin \theta) \right] \quad 9.42$$

where  $\mu = \frac{1 - \sqrt{1 - \sin^2 \theta}}{\sin \theta}$ ,

$\epsilon_u = 1$  when  $u = 0$ ,

$\epsilon_u = 2$  when  $u \neq 0$ ,

$\theta =$  angle of the incidence,

$R =$  radius of the plate, in centimeters,

$k = 2\pi/\lambda$ ,

$\lambda =$  wavelength, in centimeters, and

$J_u =$  Bessel function, of the order  $u$ .

The pressure at the center on the front and back of a circular plate for normal incidence  $\theta = 0^\circ$  or  $180^\circ$ , from equation 9.42, is

$$\left| \frac{p_0}{p} \right| = \sqrt{5 - 4 \cos kR} \quad 9.43$$

$$\left| \frac{p_{180}}{p} \right| = 1 \quad 9.44$$

The pressure frequency characteristic on the front and back of a circular baffle for normal incidence computed from equations 9.43 and 9.44 is shown in Fig. 9.14. It will be seen that the pressure at the front rises to a value of three times that in free space at  $R/\lambda = .5$ , then falls back to the same as the free space pressure at  $R/\lambda = 1$ , and repeats for  $R/\lambda = 1.5$  and  $R/\lambda = 2$ , etc. The pressure at the back is the same as the free space pressure for all frequencies. The measured pressure at the center on the front and back of a circular baffle is shown in Fig. 9.15. In order to reduce errors in measurement to a minimum, baffles of different diameters were used. In addition, several different pressure measuring arrangements were used. The results shown in Fig. 9.15 represent an average of these determinations. It will be seen that theory and experiment are in fairly good agreement. Some of the deviation may be attributed to finite size of the pressure measuring system.

The phase at the front and back of a circular baffle computed from equation 9.42 is shown in Fig. 9.16. A point in the plane wave corresponding to the plane of the baffle is the reference plane for the phase. It will be

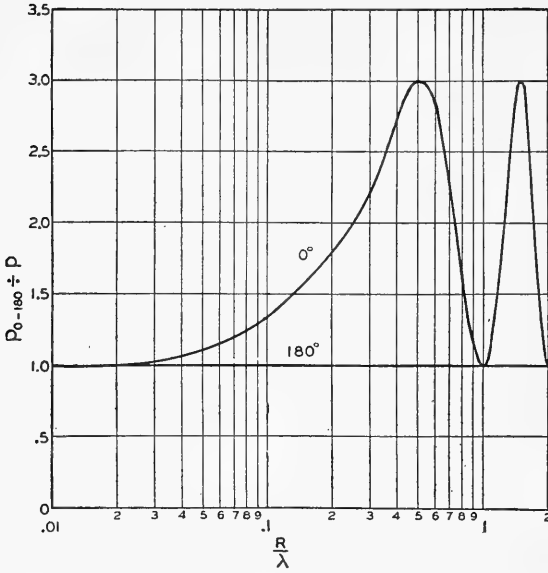

FIG. 9.14. Computed pressure frequency characteristic, at the center, on the front and the back of a circular baffle for normal incidence of the impinging sound wave.

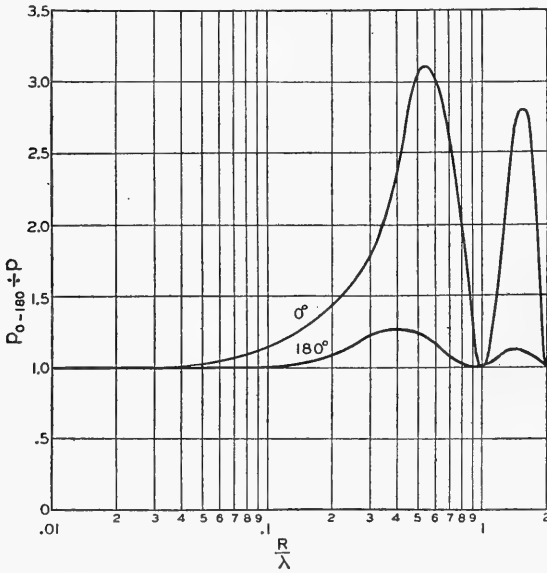

FIG. 9.15. Measured pressure frequency characteristic at the center, on the front and the back of a circular baffle for normal incidence of the impinging sound wave.



seen that for  $R/\lambda$  less than .5 the phase of the pressure at the front of the baffle leads that of the pressure in the wave. For values of  $R/\lambda$  less than .1 the phase on the front leads by the same amount as the phase on the back lags the pressure in the wave.

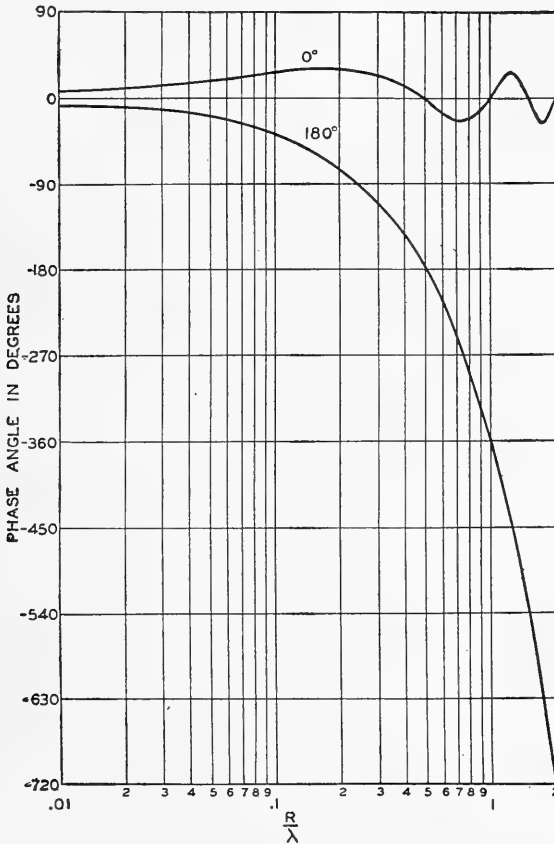

Fig. 9.16. Computed phase frequency characteristic at the center, on the front and the back of a circular baffle for normal incidence of the impinging sound wave.

Equation 9.42 may be used to compute the difference in pressure between the two sides of a relatively small ribbon located in a large baffle (Fig. 9.17). The difference in pressure between the two sides of the ribbon in a circular baffle, Fig. 9.17, is

$$\Delta p = p_\theta - p_{\theta+180} \tag{9.45}$$

where  $p_\theta$  and  $p_{\theta+180}$  may be obtained from equation 9.42. The acoustic impedance of the ribbon, Fig. 9.17, is given by

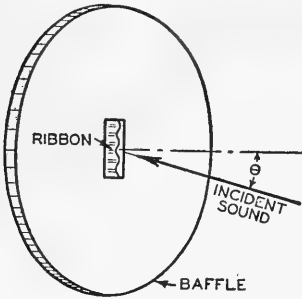

FIG. 9.17. A ribbon microphone with a large circular baffle.

$$z_{AR} = j\omega M_{AR} - \frac{j}{\omega C_{AR}} \tag{9.46}$$

where  $M_{AR}$  = inertance of the ribbon, and  $C_{AR}$  = acoustic capacitance of the ribbon.

From equation 9.21 the total force of the air load upon the ribbon is

$$f_{MA} = \frac{j\omega\rho u_{\max}\epsilon^{j\omega t}}{4\pi} \iint dS' \iint \frac{dS}{a_1} \epsilon^{jka_1} \tag{9.47}$$

The above integration extends over both sides of the ribbon and cognizance must be taken of the 180° difference in phase between the front and back when integrating between the two surfaces. The integration of equation 9.47 may be carried out by dividing the ribbon into small elements and carrying out the indicated integration.

The acoustic impedance of the air load is

$$z_{AA} = r_{AA} + jx_{AA} = \frac{f_{MA}}{A_R^2 u_{\max} \epsilon^{j\omega t}} \tag{9.48}$$

The acoustic impedance  $z_{AS}$  of the slit between the ribbon and pole pieces is given by equation 9.23.

The resonance of the ribbon is usually placed below the audible limit. Therefore, the acoustic capacitance of the ribbon may be neglected. The acoustic resistance  $r_{AA}$  of the air load is negligible save at the very high frequencies. The fundamental resonance of the ribbon is located below the audible range and the negative reactance term in equation 9.46 may be neglected. Under these conditions the acoustic impedance of the vibrating system is

$$z_{AT} = j\omega M_{AR} + j\omega M_{AA} \tag{9.49}$$

where  $M_{AA}$  = inertance of the air load.

The velocity, in centimeters per second, of the ribbon is

$$\dot{x} = \frac{\Delta\phi}{A_R z_{AT}} \tag{9.50}$$

where  $A_R$  = area of the ribbon, square centimeters.

The voltage output in abvolts is

$$e = Bl\dot{x} \quad 9.51$$

where  $B$  = flux density, in gaussses,

$l$  = length of the ribbon, in centimeters, and

$\dot{x}$  = velocity of the ribbon in centimeters, per second.

The response characteristic of a mass controlled ribbon located in a large circular baffle, Fig. 9.17, computed from equation 9.51 is shown in Fig. 9.18.

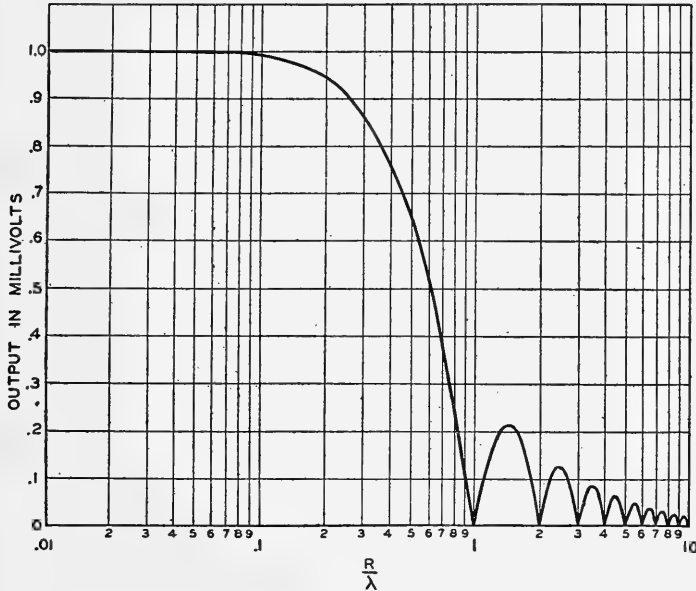

FIG. 9.18. Computed open circuit voltage response frequency characteristic of a mass controlled, electrodynamic ribbon located in a large circular baffle.

The experimental response of a ribbon microphone with a circular baffle is shown in Fig. 9.19. The agreement between the measured response and the computed response is quite good. There is some deviation between  $R/\lambda = .5$  and  $R/\lambda = .8$ . There is also some discrepancy in this region between computed and measured pressures (Figs. 9.14 and 9.15). It is interesting to note that the theoretical response of the pressure gradient microphone and the ribbon in a baffle is practically the same, Figs. 9.11 and 9.18.

The measured directional characteristics of the ribbon microphone with

a circular baffle is shown in Fig. 9.20. It will be seen that for small values of  $R/\lambda$  the directional characteristic corresponds to a cosine function. Between  $R/\lambda = \frac{3}{8}$  and  $\frac{5}{8}$  the directional pattern is sharper than a cosine characteristic. Then for  $R/\lambda$  larger than  $\frac{5}{8}$  the characteristics broaden and

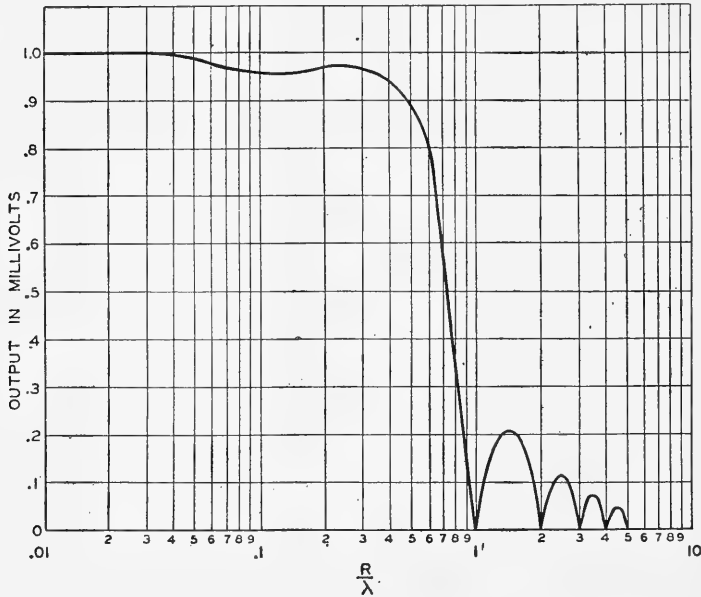

FIG. 9.19. Measured open circuit voltage response frequency characteristic of a mass controlled, electrodynamic ribbon located in a large circular baffle.

assume irregular shapes. The theoretical directional characteristics employing equations 9.45, 9.50 and 9.51 are shown in Fig. 9.21. It will be seen that the agreement with the experimental results of Fig. 9.20 is quite good. There is some deviation for  $D/\lambda = \frac{3}{4}$ . It is in this region that deviations occurred between the theoretical and experimental results for the pressure, Figs. 9.14 and 9.15, and for the response, Figs. 9.18 and 9.19. The theoretical directional characteristics for a doublet, Fig. 9.12, becomes progressively broader for  $R/\lambda = \frac{3}{8}, \frac{1}{2}$  and  $\frac{5}{8}$  and does not agree at all with the experimental results. For  $R/\lambda = \frac{3}{4}, \frac{7}{8}$  and 1 the shape of the theoretical directional characteristics of the doublet does not correspond with the experimental results. Summarizing, the theoretical directional characteristics of a ribbon microphone with a circular baffle agree within a few per

cent of the measured directional characteristics. However, the discrepancy between the measured directional characteristics of a ribbon in a circular baffle and the theoretical directional characteristic of a doublet or or

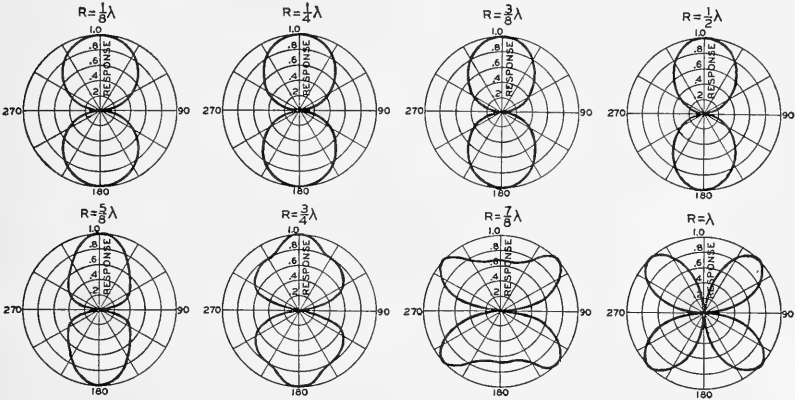

FIG. 9.20. Measured directional characteristics of a ribbon microphone with a large circular baffle (see Fig. 9.17) as a function of the radius of the baffle and the wavelength. The polar graph depicts the output, in volts, as a function of the angle, in degrees. The maximum response is arbitrarily chosen as unity.

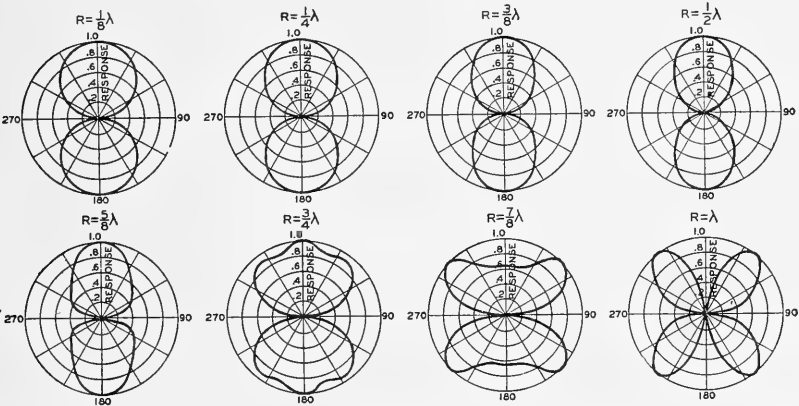

FIG. 9.21. Computed directional characteristics of a ribbon microphone with a large circular baffle (see Fig. 9.17) as a function of the radius of the baffle and the wavelength. The polar graph depicts the output, in volts, as a function of the angle, in degrees. The maximum response is arbitrarily chosen as unity.

pressure gradient system is very large for values of  $R/\lambda$  greater than  $\frac{3}{8}$ . The phase between the actuating force, equation 9.45, and the particle velocity in a plane wave, for a ribbon microphone with a circular baffle, is

shown in Fig. 9.22. It will be seen that this force leads the particle velocity by  $90^\circ$  for small values of  $R/\lambda$ . The phase angle between the voltage output of the ribbon and the particle velocity is also shown in Fig. 9.22. For small values of  $R/\lambda$  the voltage output of a mass controlled dynamic ribbon microphone with a baffle corresponds to the particle velocity in the sound wave.

The above analysis has been concerned with a ribbon located in a circular baffle. Irregular baffles instead of circular baffles are used in com-

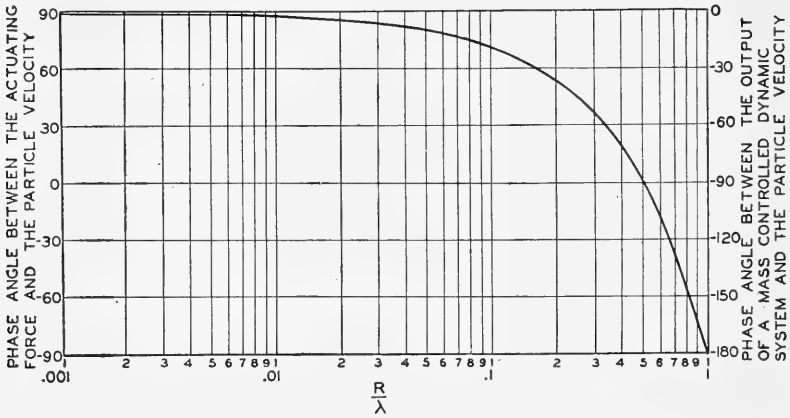

FIG. 9.22. The phase angle, in degrees, between the actuating force and the particle velocity for a mass controlled ribbon with a circular baffle as a function of  $R/\lambda$ . The phase angle between the voltage output of a mass controlled electrodynamic ribbon located in a magnetic field as a function of  $R/\lambda$ .

mercial microphones for two reasons: first, a suitable magnetic field results in an irregular baffle and, second, the sound path lengths between the two sides of an irregular baffle differ and, as a consequence, it is possible to obtain uniform directional response characteristics over a wider frequency range. An analytical solution of the irregular plate is difficult. However, the graphical method may be used and is very effective.

In well-designed velocity microphones which have been built in the past the effective sound path introduced by the baffle has been made less than one half wavelength for all frequencies within the useful range. There are two reasons for this selection of sound path: first, the response up to this frequency is quite uniform, while above this frequency the response falls off rapidly with increase of the frequency; second, in the case of an irregular baffle the directional characteristics are of the cosine type to within a few per cent of this frequency limit. A commercial microphone

is shown in Fig. 9.13. It will be seen that the effective baffle is irregular in shape. The directional characteristics of the microphone of Fig. 9.13 are shown in Fig. 9.23. Further, the deviation from a cosine characteristic is very small.

The above considerations have been concerned with a plane wave. As

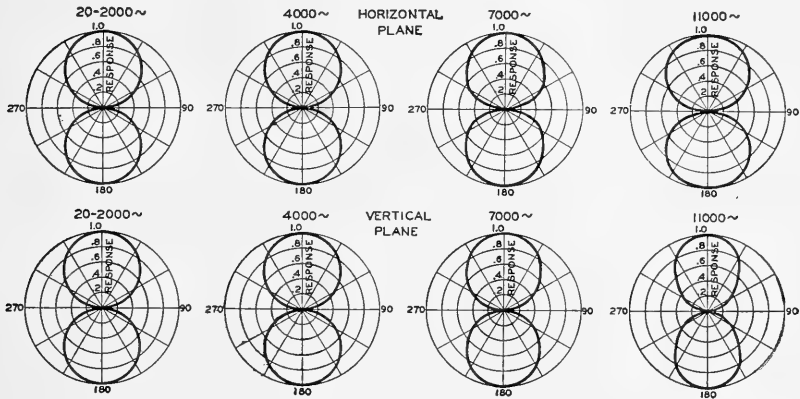

FIG. 9.23. The directional characteristic of the velocity microphone shown in Fig. 9.13. The polar graph depicts the output, in volts, as a function of the angle, in degrees. The maximum response is arbitrarily chosen as unity.

in the case of the pressure gradient microphone, it can be shown that the output of a baffle type velocity microphone corresponds to the particle velocity in a spherical wave. The response of a baffle type velocity microphone as a function of the distance from a point source and the frequency is shown in Fig. 9.26A.

**9.4. Unidirectional Microphones**<sup>24, 25, 26</sup>. — The unidirectional microphone consists of the combination of a bidirectional microphone and a nondirectional microphone. The performance of this system is a function of the distance from the source, the spacing of the units, the sensitivity of the units and the phase angle between the units. These fundamental characteristics will now be considered.

A unidirectional microphone consisting of a ribbon velocity element and a ribbon pressure element (see Sec. 9.2D3 and Fig. 9.8) is shown in Fig. 9.24. The damped pipe terminating the back of the pressure ribbon is folded in

<sup>24</sup> Olson, H. F., *Jour. Acous. Soc. Amer.*, Vol. 3, No. 3, p. 315, 1932.

<sup>25</sup> Weinberger, Olson and Massa, *Jour. Acous. Soc. Amer.*, Vol. 5, No. 2, p. 139, 1933.

<sup>26</sup> Olson, H. F., *Jour. Soc. Mot. Pic. Eng.*, Vol. 27, No. 3, p. 284, 1936.

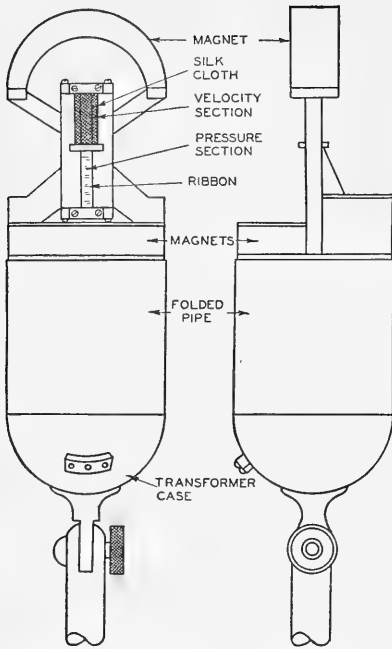

FIG. 9.24. Unidirectional microphone with the screen removed. Ribbon type pressure and velocity elements.

a dynamic pressure element is shown in Fig. 9.25. Equalizers are used to correct the amplitude and phase of the dynamic element to conform with the velocity element.

A. *The Response of the Unidirectional Microphone as a Function of the Distance and the Frequency*<sup>27</sup>. — The low frequency response of the velocity microphone is accentuated when the distance between the source and the microphone is less than a wavelength. The same effect occurs to a smaller extent in the unidirectional microphone. It

the form of a labyrinth and enclosed in a case. The velocity and pressure sections are formed from a single continuous ribbon. A common magnetic structure is used for both the velocity and pressure sections. Due to a finite length of pipe for the pressure section the velocity of the pressure ribbon leads the pressure in the sound wave at the low frequencies. See Sec. 9.2D3 and Fig. 9.9. The resistance (silk cloth) introduces a corresponding phase shift in the velocity section. At the high frequencies the phase shifts in the two elements are made the same by suitable geometrical configurations of the field structure.

A unidirectional microphone consisting of a ribbon velocity element and

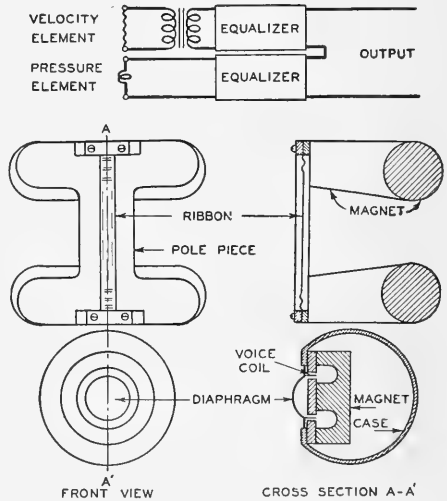

FIG. 9.25. Unidirectional microphone consisting of a ribbon type velocity element and a dynamic type pressure element.

<sup>27</sup> Olson, H. F., *Broadcast News*, No. 30, p. 3, May, 1939.



is the purpose of this section to consider the response of the unidirectional microphone as a function of the frequency and distance from a point source.

The voltage output of a nondirectional microphone as a function of the distance  $r$  is given by

$$e_{ND} = \frac{R_1}{r} \sin \omega t \quad 9.52$$

where  $R_1$  = sensitivity constant of the microphone,

$$\omega = 2\pi f,$$

$f$  = frequency, in cycles per second,

$r$  = distance, in centimeters, from a point source of sound, and

$t$  = time, in seconds.

The voltage output of the bidirectional velocity microphone as a function of the distance and the wavelength  $\lambda$ , in centimeters, is

$$e_{BD} = R_2 \left( \frac{1}{r} \sin \omega t - \frac{\lambda}{2\pi r^2} \cos \omega t \right) \cos \theta \quad 9.53$$

where  $R_2$  = sensitivity constant of the microphone,

$r$  = distance, in centimeters from a point source of sound, and

$\theta$  = angle between the direction of the incident sound and the normal to the ribbon.

If the output of the unidirectional microphone as a function of the angle  $\theta$  is to be a cardioid of revolution for plane waves, then  $R_1$  must be made equal to  $R_2$ . The ratio of the output of the unidirectional microphone as a function of the distance and frequency as compared to a pressure microphone is

$$\text{Response Ratio} = \sqrt{\frac{\left(\frac{1}{r} + \frac{\cos \theta}{r}\right)^2 + \left(\frac{\lambda \cos \theta}{2\pi r^2}\right)^2}{\left(\frac{2}{r}\right)^2}} \quad 9.54$$

This ratio for  $\theta = 0, 30^\circ, 60^\circ, 90^\circ, 120^\circ, 150^\circ$  and  $180^\circ$  for 1, 2 and 5 feet is shown in Fig. 9.26. The same ratio for a conventional velocity microphone for 1, 2 and 5 feet is shown in Fig. 9.26. It will be seen that the accentuation in the unidirectional microphone is smaller than in the case of the velocity microphone.

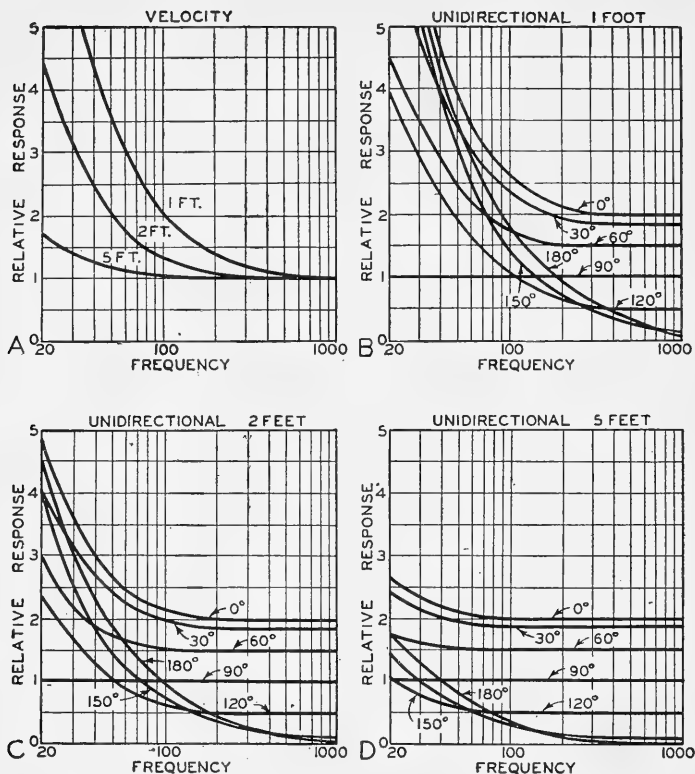

FIG. 9.26. *A*. The relative voltage output of a velocity (or pressure gradient) microphone as compared to a nondirectional pressure microphone for distances of 1, 2 and 5 feet. *B*, *C*, *D*, the relative voltage output of a unidirectional microphone as compared to a nondirectional pressure microphone for distances of 1, 2 and 5 feet and for various angles of the incident sound.

*B*. *Efficiency of Energy Response to Random Sounds of the Unidirectional Microphone as a Function of the Relative Sensitivities of the Bidirectional and Nondirectional Microphones*<sup>28</sup>.— The unidirectional microphone consists of the combination of a bidirectional microphone, in which the output is a function of the cosine of the angle of incidence, and a nondirectional microphone. In general, it is customary to make the output of the bidirectional microphone for  $\theta = 0$  equal to the nondirectional microphone. For this condition the directional characteristic is a cardioid of revolution. In the case of both the bidirectional and the cardioid uni-

<sup>28</sup> Olson, H. F., *Broadcast News*, No. 30, p. 3, May, 1939.

directional, the ratio of energy response to generally reflected sound is one-third that of a nondirectional microphone. It is interesting to investigate the efficiency of response to random sound of other ratios of sensitivity of the bidirectional to the nondirectional unit.

The output of a microphone consisting of a bidirectional and nondirectional unit is given by

$$e_{UD} = R_1 + R_2 \cos \theta \quad 9.55$$

where  $R_1$  = voltage output of the nondirectional microphone, and  
 $R_2$  = voltage output of the bidirectional unit for  $\theta = 0$ .

The efficiency of energy response of the unidirectional microphone as compared to a nondirectional microphone for sounds originating in random directions, all directions being equally probable, is

$$\begin{aligned} \text{Efficiency} &= \frac{2\pi \int_0^\pi (R_1 + R_2 \cos \theta)^2 \sin \theta \, d\theta}{4\pi(R_1 + R_2)^2} \\ &= \frac{1}{6} \frac{(R_1 + R_2)^3 - (R_1 - R_2)^3}{(R_1 + R_2)^2 R_2} \end{aligned} \quad 9.56$$

For the standard velocity microphone  $R_1 = 0$ ,  $R_2 = 1$  and the ratio is  $\frac{1}{3}$ . For the cardioid unidirectional  $R_1 = 1$  and  $R_2 = 1$  and the ratio is  $\frac{1}{3}$ . However, for other values the ratio is different. For example, between  $R_1/R_2 = 0$  to  $R_1/R_2 = 1$  the efficiency is less than  $\frac{1}{3}$  and becomes .25 for  $R_1/R_2 = .33$ . The efficiency for various values of the ratio  $R_1/R_2$  is shown in Fig. 9.27. The data in Fig. 9.27 shows that it is not so important that the two microphones be of the same sensitivity. It is important, however, that the ratio  $R_1/R_2$  be equal to 1 or less than 1.

The same results are shown in Fig. 9.28 by means of polar diagrams. This figure shows that the energy response of the bidirectional microphone and the cardioid unidirectional is the same. However, for  $0 < R_1/R_2 < 1$  the response to random sounds is less in the case of either of these two microphones.

C. *Efficiency of Energy Response to Random Sounds of a Unidirectional Microphone as a Function of the Phase Angle between the two Units*<sup>29</sup>. — The preceding discussions have assumed that the phase angle between the outputs of the two units did not change with frequency. There are two

<sup>29</sup> Olson, H. F., *Broadcast News*, No. 30, p. 3, May, 1939.

principal sources of phase shift between the two units, namely: a phase shift due to a finite separation and a phase shift due to a difference in the phase frequency characteristics.

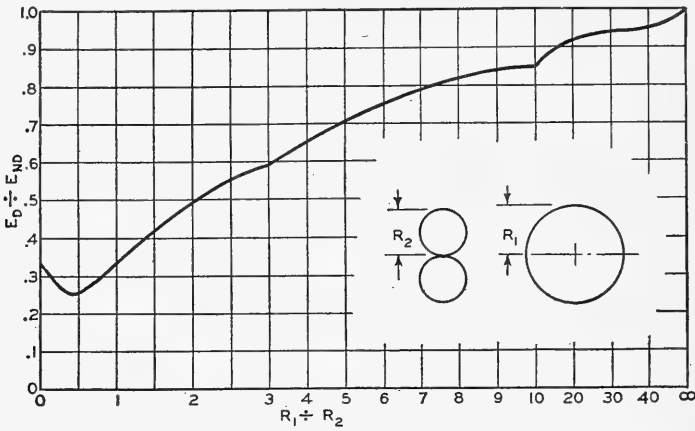

FIG. 9.27. The ratio of energy response to random sounds of a directional microphone consisting of a bidirectional and a nondirectional unit as a function of the ratio of the outputs of the elements, as compared to the nondirectional microphone.  $E_{ND}$  energy response of a nondirectional microphone.  $E_D$  energy response of a directional microphone.  $R_1$  voltage output of the nondirectional unit.  $R_2$  voltage output of the directional unit.

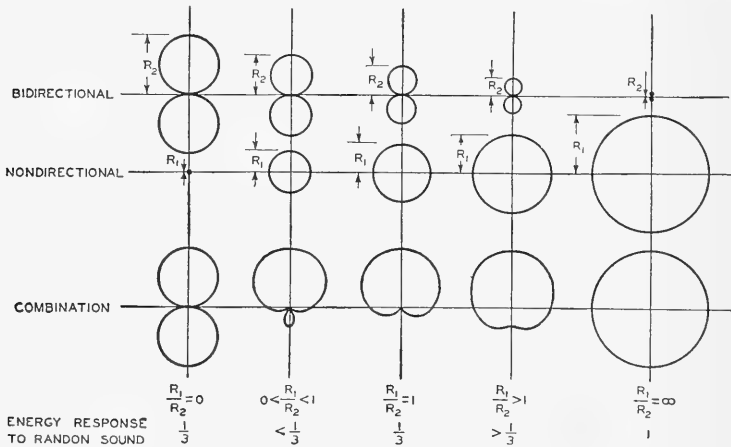

FIG. 9.28. Directional diagrams of various combinations of bidirectional and nondirectional microphones and the energy response to random sounds.

Consider the case in which there is a phase shift  $\phi$  between the output of the bidirectional and nondirectional units. The output of each sepa-

rate unit is  $e_0$  volts. The output of the combination is

$$e = e_0 \sqrt{(\cos \theta + \cos \phi)^2 + (\sin \phi)^2} \tag{9.57}$$

The efficiency of the energy response of the above system to that of a nondirectional microphone is

$$\text{Efficiency} = \frac{2\pi e_0 \int_0^\pi [(\cos^2 \theta + 2 \cos \theta \cos \phi + \cos^2 \phi) + \sin^2 \phi] \sin \theta \, d\theta}{16\pi e_0^2} \tag{9.58}$$

$$\text{Efficiency} = \frac{2\pi e_0^2 \int_0^\pi [\cos^2 \theta + 2 \cos \theta \cos \phi + 1] \sin \theta \, d\theta}{16\pi e_0^2} = \frac{1}{3} \tag{9.59}$$

The efficiency is the same as in the case of no phase angle shift.

If the units are separated by a finite distance  $d$ , then there will be a phase difference between the units which is

$$\phi = \frac{d}{\lambda} 360 \cos \theta \tag{9.60}$$

where  $d$  = distance between the units, in centimeters,

$\lambda$  = wavelength, in centimeters, and

$\theta$  = angle between the direction of the incident sound and the normal to the ribbon.

Note that this separation is in line with the units. Substituting  $\phi = (d/\lambda) 360 \cos \theta = K \cos \theta$  in equation 9.57 the output is

$$e = e_0 \sqrt{[\cos \theta + \cos (K \cos \theta)]^2 + [\sin (K \cos \theta)]^2} \tag{9.61}$$

The efficiency of the energy response of the above system to a non-directional system is given by

$$\text{Efficiency} = \frac{2\pi e_0^2 \int_0^\pi \{[\cos \theta + \cos (K \cos \theta)]^2 + [\sin (K \cos \theta)]^2\} \sin \theta \, d\theta}{16\pi e_0^2} = \frac{1}{3} \tag{9.62}$$

That is, the efficiency is independent of the separation between the units. Of course, for very large distances the separation disturbs the response for  $\theta = 0$ . However, in the conventional microphone this does not occur. Therefore, the effect of finite size has no effect on the efficiency of energy response to random sounds.

D. *Distortion of the Directional Pattern in the Unidirectional Microphone.* — Deviations from the cardioid characteristic in the unidirectional microphone are due to:

1. Phase shift in the velocity microphone due to deviation from a pure mass reactance.
2. Phase shift in the velocity microphone due to diffraction.
3. Phase shift in the pressure microphone due to deviation from resistance control.
4. Phase shift in the pressure microphone due to diffraction.
5. Deviation in the output from a cosine directional characteristic in the velocity microphone.
6. Deviation in output with angle in the pressure microphone.
7. Unequal sensitivity of the two elements.

The phase angle between the output of a velocity microphone and the particle velocity in a plane wave has been considered in Sec. 9.3B. The phase shift in a pressure ribbon microphone has been considered in Sec. 9.2D3. It is possible to adjust these phase shifts and those due to diffraction so that the cancellation for  $180^\circ$  will be of the order of  $-20$  db up to 10,000 cycles. In the case of the dynamic pressure unit the problem of maintaining appropriate phase shifts is more difficult.

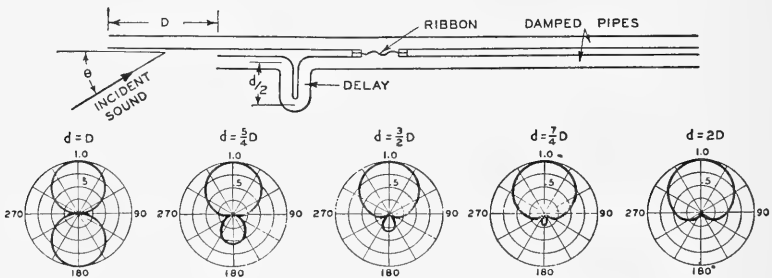

FIG. 9.29. A directional microphone employing a phase shifting system. The polar graphs show the directional characteristics for various ratios of  $d/D$ . The polar graph depicts the output, in volts, as a function of the angle, in degrees. The maximum response is arbitrarily chosen as unity.

E. *Phase Shifting Unidirectional Microphones.* — A unidirectional microphone consisting of a nondirectional and bidirectional microphone has been described in the preceding section. It is the purpose of this section to describe other means for obtaining directional response.

The elements of a phase shifting microphone are shown in Fig. 9.29.

The open ends of the pipes are separated by a distance  $D$ . A bend of length  $d$  is placed in the shorter pipe. The ribbon element measures the difference in pressure between the two pipes. The difference in pressure between the two pipes is given by

$$\Delta p = 2p_0 \sin \left( \frac{d-D}{\lambda} \pi + \frac{D\pi}{\lambda} \cos \theta \right) \quad 9.63$$

where  $p_0$  = sound pressure, in dynes per square centimeter,

$D$  = separation between the receiving ends of the pipes, in centimeters,

$d$  = acoustic path introduced by the bend, in centimeters,

$\lambda$  = wavelength, in centimeters, and

$\theta$  = angle the incident pencils of sound make with the axis of the system.

If the distances  $D$  and  $d$  are small compared to the wavelength,  $\Delta p$  will be proportional to the frequency. If a mass controlled electrodynamic element is used, the output will be independent of the frequency.

A series of directional characteristics for various ratios of  $D$  to  $d$  is shown in Fig. 9.29.

A diaphragm actuated crystal unidirectional microphone<sup>30</sup> employing a phase shifting network is shown in Fig. 9.30. The principle is essentially the same as that of Fig. 9.29 described above. The vector diagrams show the action for sound incident at  $0^\circ$  and  $180^\circ$ . Considerable deviation from the cardioid characteristic occurs at the higher frequencies due to the relatively large physical size of the microphone compared to the wavelength of the sound. Since the actuating force upon the crystal, and hence the voltage output, is proportional to the frequency, compensation must be employed to obtain a microphone uniformly sensitive with respect to frequency.

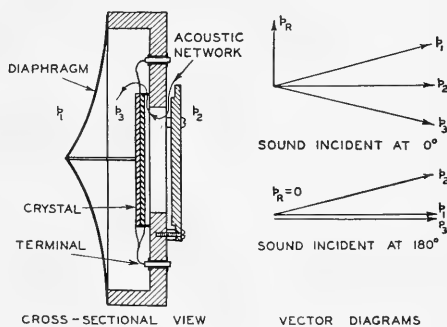

FIG. 9.30. Crystal unidirectional microphone employing a phase shifting network. The vector diagram depicts the magnitude and phase available for driving the diaphragm for  $0^\circ$  and  $180^\circ$ .

<sup>30</sup> Baumzweiger, Benj., *Electronics*, Vol. 12, No. 2, p. 62, 1939.

**9.5. Miscellaneous Microphones.** — A. *Lapel Microphone.* — Lapel microphone<sup>30A, 30B</sup> is a term applied to a small microphone which can be hooked into the buttonhole of the coat of a speaker. The principal purpose of a lapel microphone, as contrasted to a stationary microphone placed somewhere in front of the speaker, is to allow the speaker freedom to move about the stage or lecture platform or to turn away from the audience without any loss in intensity of the amplifier due to variation in distance from the microphone. The response frequency characteristic of a lapel microphone is usually adjusted so that the output is the same as that of an ordinary microphone located directly in front of the speaker.

The carbon, crystal, and ribbon velocity microphones are the principal types in use for lapel microphones. These microphones are usually made small in size and light in weight. Save for these characteristics, the lapel microphones are essentially the same as those described in the preceding sections.

B. *Throat Microphone.* — Throat microphone is a term applied to a microphone which is held in place against the throat near the larynx by a strap around the neck. The vibrations produced by the vocal cords are transmitted to the microphone by flesh conduction. The sibilant sounds are transmitted by conduction through the throat and by air conduction. By suitable compensation with respect to the frequency, tolerable intelligibility may be obtained.

The throat microphone allows the wearer more freedom of action than in the case of the conventional microphone. It is particularly useful for airplane pilots because it does not interfere with vision, the use of oxygen apparatus, etc.

In order to obtain high outputs and thereby reduce the size of the amplifier, carbon microphones are generally used in aircraft throat microphones.

C. *Hot Wire Microphone.* — The hot wire microphone depends for its operation upon the cooling effect of a sound wave, with the resultant change in resistance, on an electrically heated fine wire. The cooling effect is primarily due to the particle velocity in the sound wave. Two changes in resistance occur, namely: a steady change and an alternating change of twice the frequency of the sound wave. The steady change in resistance may be used to measure or indicate the intensity of a sound wave by plac-

---

<sup>30A</sup> Olson and Carlisle, *Four. Inst. Rad. Eng.*, Vol. 22, No. 12, 1934, p. 1354.

<sup>30B</sup> Olson and Massa, "Applied Acoustics," P. Blakiston's Son and Co., Philadelphia.



ing the microphone in one arm of a Wheatstone bridge<sup>31</sup>. The sensitivity may be increased at a particular frequency by placing the wire in the neck of a Helmholtz resonator. For sound reproduction, a polarizing air stream must be used so that the alternating change in resistance will correspond to the undulations of the sound wave. Under these conditions, at a given frequency, the resistance variation is nearly proportional to the product of the air stream velocity, the particle velocity in the sound wave and the cosine of the included angle.

D. *Batteryless Telephones*<sup>31A</sup> (*Sound Power Telephones*). — The earliest telephones had no source of energy other than the speaker's voice. However, these were soon replaced by the more sensitive carbon granule transmitter and battery combination. During recent years the application of acoustical engineering principles, together with better materials, has resulted in a batteryless instrument which is very practical for use in construction camps, warehouses, ships and apartment houses. These telephones have been built using electromagnetic, electrodynamic and crystal electroacoustic transducers. The diaphragms are about 2 inches in diameter. The microphone and telephone are identical save for the mounting case. In use, the microphone and telephone are connected in series across the line.

**9.6. Highly Directional Microphones.** — A. *Parabolic Reflector*<sup>32, 33, 34, 34A</sup>. — Reflectors have been used for years for concentrating and amplifying all types of wave propagation. The surface of the parabolic reflector is shaped so that the various pencils of incident sound parallel to the axis are reflected to one point called the focus (Fig. 9.31). To obtain an appreciable gain in pressure at the focus the reflector must be large compared to the wavelength of the incident sound. This requirement of size must also be satisfied in order to obtain sharp directional characteristics. If this condition is satisfied at the low frequencies the size of the reflector becomes prohibitive to be used with facility.

A cross-sectional view of a parabolic reflector and a pressure microphone located at the focus is shown in Fig. 9.31. When the microphone is located at the focus the gain at the high frequencies is considerably greater than at the mid frequency range. The accentuation in high fre-

<sup>31</sup> Tucker and Paris, *Trans. Roy. Soc.*, Vol. 221, p. 389, 1921.

<sup>31A</sup> Atkins, G. E., *Bell Lab. Record*, Vol. 16, No. 8, p. 282, 1938.

<sup>32</sup> Hanson, O. B., *Jour. Acous. Soc. Amer.*, Vol. 3, No. 1, Part 1, p. 81, 1931.

<sup>33</sup> Dreher, Carl, *Jour. Soc. Mot. Pic. Eng.*, Vol. 16, No. 1, p. 29, 1932.

<sup>34</sup> Olson and Wolff, *Jour. Acous. Soc. Amer.*, Vol. 1, No. 3, p. 410, 1930.

<sup>34A</sup> Olson and Massa, "Applied Acoustics," P. Blakiston's Son and Co., Philadelphia.

quency response may be overcome by moving the microphone slightly out of focus. This expedient also tends to broaden the sharp directional characteristics at the high frequencies.

The directional characteristics of a parabolic reflector 3 feet in diameter, used with a pressure microphone, are shown in Fig. 9.31. It will be seen

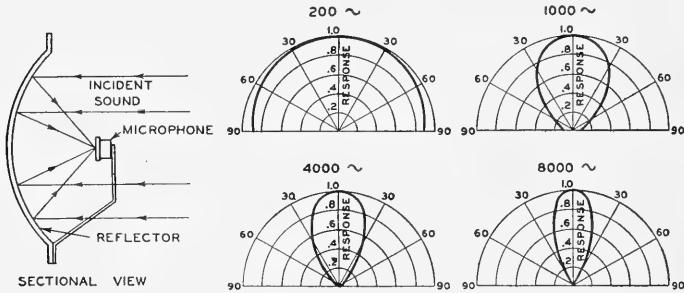

FIG. 9.31. Cross-sectional view of a parabolic reflector for a microphone. The polar graphs show the directional characteristics. The polar graph depicts the pressure, in dynes, at the microphone as a function of the angle, in degrees. The maximum response is arbitrarily chosen as unity. (After Hanson.)

that the directivity increases with frequency. For example, the system is practically nondirectional at 200 cycles. On the other hand, the directional characteristic is very sharp at 8000 cycles.

B. *Line Microphones*<sup>35, 35A, 35B</sup>. — A line microphone is a microphone consisting of a number of small tubes with the open end, as pickup points, equally spaced along a line and the other end connected to a common junction to a transducer element for converting the sound vibrations into the corresponding electrical variations. In the line systems to be considered, the transducer will be a ribbon element located in a magnetic field and terminated in an acoustic resistance. Under these conditions the output of the pipes can be added vectorially.

1. *Line Microphone: Useful Directivity on the Line Axis. Simple Line.* — This microphone consists of a number of small pipes with the open ends, as pickup points, equally spaced on a line and the other ends joined at a common junction decreasing in equal steps (Fig. 9.32). A ribbon element, connected to the common junction and terminated in an

<sup>35</sup> Olson, H. F., *Jour. Inst. Rad. Eng.*, Vol. 27, No. 7, p. 438, 1939.

<sup>35A</sup> Mason and Marshall, *Jour. Acous. Soc. Amer.*, Vol. 10, No. 3, p. 206, 1939.

<sup>35B</sup> Olson, H. F., *Broadcast News*, No. 28, p. 32, July, 1938.

acoustic resistance in the form of a long damped pipe, is used for transforming the acoustical vibrations into the corresponding electrical variations.

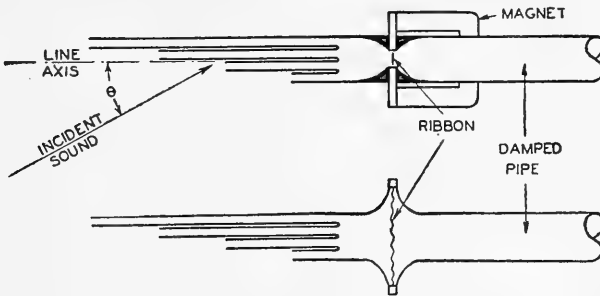

FIG. 9.32. Line Microphone. Useful directivity on the line axis. This microphone consists of a large number of small pipes arranged in a line with the distance from the opening of each pipe to the common junction decreasing in equal steps. The system is terminated in a ribbon element and an acoustic resistance.

The contribution, in dynes per square centimeter, by any element  $n$  at the common junction of the microphone may be expressed as

$$\begin{aligned}
 p_n &= B_n \cos 2\pi \left( ft - \frac{x_n - x_n \cos \theta}{\lambda} \right) \\
 &+ j B_n \sin 2\pi \left( ft - \frac{x_n - x_n \cos \theta}{\lambda} \right)
 \end{aligned}
 \tag{9.64}$$

$$p_n = B_n \epsilon^{2\pi j ft} \epsilon^{2\pi j (x_n - x_n \cos \theta) / \lambda}
 \tag{9.65}$$

- where  $f$  = frequency, in cycles per second,
- $t$  = time, in seconds,
- $x_n$  = distance of the element  $n$  from the center of the line, in centimeters,
- $\lambda$  = wavelength, in centimeters,
- $\theta$  = angle between axis of the line and the incident sound, and
- $B_n$  = amplitude of the pressure due to element  $n$ , in dynes per square centimeter.

In the case of a uniform line, with the strength a constant, the resultant when all the vectors are in phase is  $B_n l$ , where  $l$  is the length of the line.

The ratio  $R_\theta$ , of the response for the angle  $\theta$  to the response for  $\theta = 0$  is

$$R_\theta = \frac{1}{B_n l} \left| \int_{-l/2}^{l/2} B_n \epsilon^{2\pi j [ft + (x - x \cos \theta) / \lambda]} dx \right|
 \tag{9.66}$$

The absolute value of the term on the right is given by

$$R_\theta = \frac{1}{l} \left| \int_{-l/2}^{l/2} e^{2\pi j(x-x \cos \theta)/\lambda} dx \right| \quad 9.67$$

$$R_\theta = \frac{\sin \frac{\pi}{\lambda} (l - l \cos \theta)}{\frac{\pi}{\lambda} (l - l \cos \theta)} \quad 9.68$$

The directional characteristics of the microphone of Fig. 9.32 for various ratios of length of the line to the wavelength are shown in Fig. 9.33.

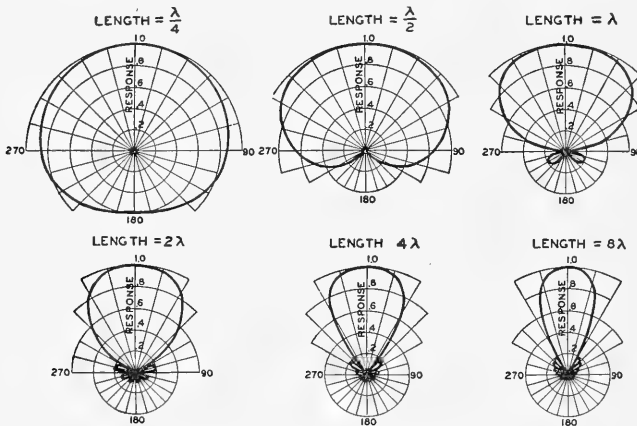

FIG. 9.33. The directional characteristics of the microphone shown in Fig. 9.32 as a function of the ratio of the length of the line to the wavelength. The polar graph depicts the output, in volts, as a function of the angle, in degrees.

These characteristics are surfaces of revolution about the line as an axis. This microphone is useful for collecting sounds arriving from directions making small angles with the microphone axis.

2. *Line Microphone: Useful Directivity on the Line Axis. Line with Progressive Delay.* — As in the case of Fig. 9.32 this microphone consists of a number of small pipes with the open ends, as pickup points, equally spaced on a line and the other ends joined at a common junction. In addition, there is inserted a delay which is proportional to the distance from the end of the line or the pickup point nearest the common junction (Fig. 9.34).

$$R_\theta = \frac{1}{B_n l} \left| \int_{-l/2}^{l/2} B_n \epsilon^{2\pi j[(x-x \cos \theta)/\lambda] + d/\lambda} dx \right| \quad 9.69$$

where  $d$  is the path length of the delay introduced for the point furthest removed from the common junction.

$$R_{\theta} = \frac{\sin \frac{\pi}{\lambda} (l - l \cos \theta + d)}{\frac{\pi}{\lambda} (l - l \cos \theta + d)} \tag{9.70}$$

The directional characteristic of the microphone of Fig. 9.34 for various ratios of the length of the line to the wavelength, and for a delay path of

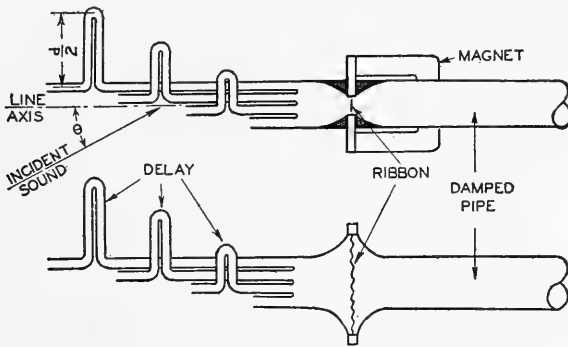

FIG. 9.34. Line Microphone. Useful directivity on the line axis. This microphone differs from Fig. 9.32 in that a delay is inserted in each small pipe. The amount of delay is proportional to the distance from the pipe opening to the pickup point nearest the common junction.

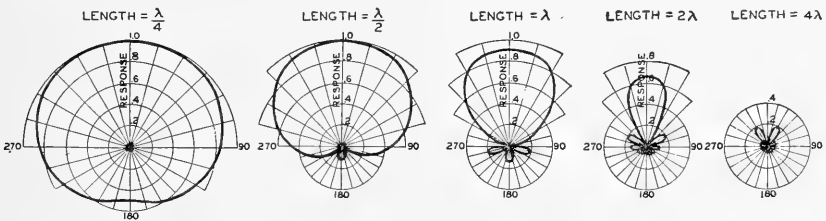

FIG. 9.35. The directional characteristics of the microphone shown in Fig. 9.34 for a time delay equivalent to one-quarter of the length of the line as a function of the ratio of the length of the line to the wavelength. The polar graph depicts the output, in volts, as a function of the angle, in degrees.

one fourth times the length of the line is shown in Fig. 9.35. Comparing Fig. 9.35 with Fig. 9.33, it will be seen that the same directional characteristic can be obtained with a shorter line by introducing appropriate

delay. In the case of a delay path comparable to the wavelength, loss in sensitivity occurs.

3. *Line Microphone: Useful Directivity on the Line Axis. Two Lines and a Pressure Gradient Element.* — This microphone consists of two lines of the type shown in Fig. 9.34 arranged so that the ribbon element measures the difference in pressure generated in the two lines (Fig. 9.36). The

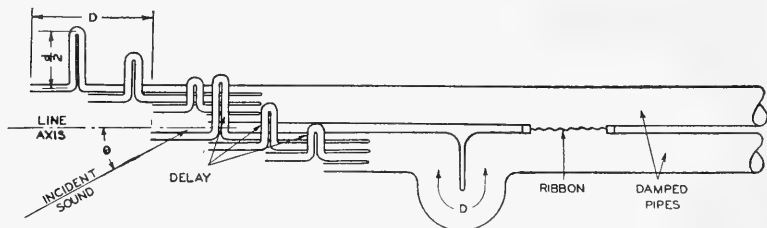

FIG. 9.36. Line Microphone. Useful directivity on the line axis. This microphone consists of two lines of the type shown in Fig. 9.34 displaced by a distance  $D$  along the axis. In the line nearest the ribbon element a bend is inserted which introduces a path length  $D$ . The ribbon element measures the difference in pressure in the two lines.

centers of the two lines are displaced by a distance  $D$ . In the line nearest the element, a bend of length  $D$  is inserted between the junction and the ribbon element.

To show the action of the pressure gradient system, assume that the length of all the small pipes is the same and the openings between the two sets are separated by a distance  $D$ . Under these conditions the line systems are nondirectional.

The difference between the forces on the two sides of the ribbon, assuming the mass reactance of the ribbon is large compared to the resistance of the damped pipes, may be expressed as

$$f_M = A \cos(2\pi ft) \sin\left(\frac{\pi D \cos \theta}{\lambda}\right) \quad 9.71$$

where  $A = \text{constant}$ , including the pressure of the impinging sound wave and dimensions of the microphone.

If  $D$  is small compared to the wavelength, equation 9.71 becomes

$$f_M = A \frac{\pi D}{\lambda} \cos(2\pi ft) \cos \theta \quad 9.72$$

Equation 9.72 shows that the force available for driving the ribbon is proportional to the frequency and the cosine of the angle  $\theta$ .

Employing mass controlled ribbon of mass  $m_r$ , the velocity is given by

$$\begin{aligned} \dot{x} &= \frac{A}{j2\pi f m_r} \left( \frac{\pi D}{\lambda} \right) \cos(2\pi f t) \cos \theta \\ &= \frac{A}{2\pi m_r} \left( \frac{\pi D}{c} \right) \sin 2\pi f t \cos \theta \end{aligned} \tag{9.73}$$

This quantity is independent of the frequency and, as a consequence, the ratio of the generated voltage to the pressure in the sound wave will be independent of the frequency.

The above discussion assumes that the lines are nondirectional. The directional characteristics of the individual lines of Fig. 9.36 are given by equation 9.70. The directional characteristics of the microphone, shown in Fig. 9.36, for  $D$  small compared to the wavelength are the product of equations 9.70 and 9.73. The directional characteristics may be written as

$$R_\theta = \frac{\sin \frac{\pi}{\lambda}(l - l \cos \theta + d)}{\frac{\pi}{\lambda}(l - l \cos \theta + d)} \cos \theta \tag{9.74}$$

The directional characteristics of the microphone shown in Fig. 9.36 for various ratios of the length of the line to the wavelength for a delay of one quarter times the length of the line are shown in Fig. 9.37. A measure

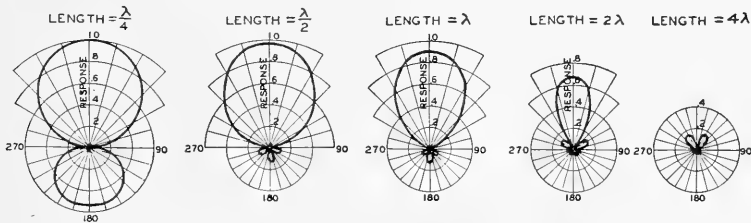

FIG. 9.37. The directional characteristics of the microphone shown in Fig. 9.35 for a time delay of one-quarter the length of the line as a function of the ratio of the length of the lines to the wavelength. The polar graph depicts the output, in volts, as a function of the angle, in degrees.

of the value of a line with progressive delay and a pressure gradient element for improving the directivity may be obtained by comparing Fig. 9.37 with Fig. 9.33. Employing these expedients approximately the same directivity can be obtained with a line of one quarter the length of the simple line shown in Fig. 9.33.

4. *Ultradirectional Microphone*<sup>36, 36A</sup>.—Directional microphones employing lines of various types have been considered in the preceding section. These directional characteristics indicated considerable variation with frequency. Experience gained from work on reflectors a few years ago indicated that a directional characteristic which varies with frequency is undesirable, principally due to the introduction of frequency discrimination for points removed from the axis. In addition, the response to reflected sound is a function of the frequency which alters the reverberation characteristics of received sound.

From the results of experiments upon directional systems, it appears that a microphone with a small solid angle of pickup would be useful in recording sound motion pictures, in television pickup, in certain types of sound broadcast as, for example, symphony and stage productions, and in many applications of sound re-enforcing. The acoustic lines referred to above seem to be the logical solution of the problem from the standpoint

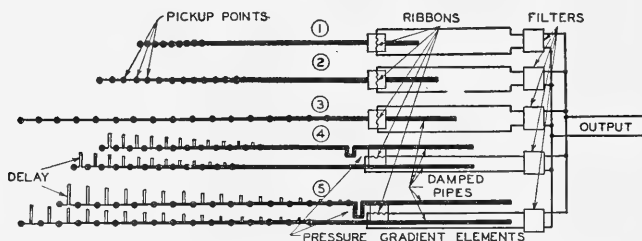

FIG. 9.38. Ultradirectional microphone consisting of five units. Units 1, 2 and 3 are of the type shown in Fig. 9.32. Units 4 and 5 are of the type shown in Fig. 9.36. An electrical filter system is used to allocate the output of the units to their respective ranges.

of size and portability. However, the directional characteristics must be independent of the frequency. This can be accomplished by employing a number of separate lines, each covering a certain portion of the frequency range. It is the purpose of this section to describe an ultradirectional microphone consisting of five separate lines.

The ultradirectional microphone shown schematically in Fig. 9.38 consists of five units. Units 1, 2 and 3 are of the type shown in Fig. 9.32. Units 4 and 5 are of the type shown in Fig. 9.36. An electrical filter system is used to allocate the outputs of the units to their respective ranges.

<sup>36</sup> Olson, H. F., *Four. Inst. Rad. Eng.*, Vol. 27, No. 7, p. 438, 1939.

<sup>36A</sup> Olson and Massa, "Applied Acoustics," P. Blakiston's Son and Co., Philadelphia.



The response characteristics of the units with the filter systems are shown in Fig. 9.39. Figure 9.40 illustrates the principles used in obtaining uniform directional characteristics. Figure 9.40A is the directional characteristic of line 3 at 700 cycles. Figure 9.40B shows the directional characteristics of lines 2 and 3 at 950 cycles. The resultant of these characteristics is also shown in Fig. 9.40B. The same is shown in Fig. 9.40C for 1250

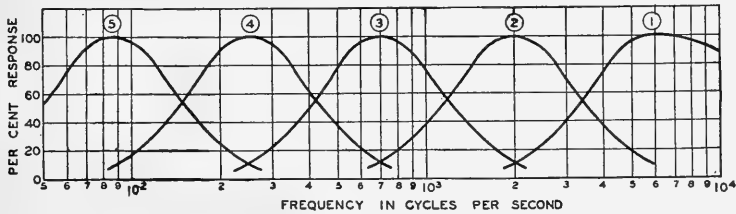

FIG. 9.39. Voltage response frequency characteristics of the unit sand filter system shown in Fig. 9.38.

cycles. In Figs. 9.40B and 9.40C the directional characteristic of line 2 is broader than Fig. 9.40A while the characteristic of line 3 is narrower. The resultant of lines 2 and 3 is a directional characteristic very close to Fig. 9.40A. The directional characteristics of the microphone shown in Fig. 9.38 for the range from 85 to 8000 cycles, except for the small lobes

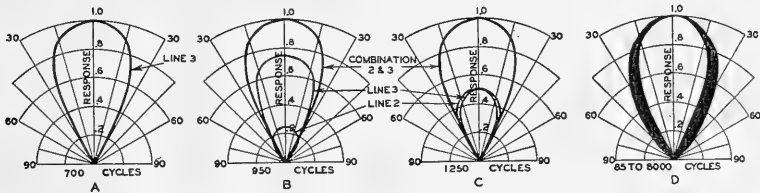

FIG. 9.40. A. The directional characteristic of line 3 at 700 cycles. B. The directional characteristics of lines 2 and 3 and the resultant at 950 cycles. C. The directional characteristics of lines 2 and 3 and the resultant of 1250 cycles. D. The directional characteristics of the microphone shown in Fig. 9.38 for the range from 85 to 8000 cycles fall within the shaded area.

for angles greater than  $90^\circ$ , fall within the shaded area of Fig. 9.40D. Considering that this microphone has a frequency range of  $6\frac{1}{2}$  octaves, it is a remarkably uniform characteristic.

C. *Directional Efficiency of a Directional Sound Collecting System.* — The ratio of energy response of a nondirectional microphone as compared to a directional microphone for sounds originating in random directions,

all directions being equally probable, is termed the directional efficiency of a directional microphone.

In many of the systems described above, determining the directional efficiency becomes a rather cumbersome job. However, the directional efficiencies of the cosine functions are easily determined. A few of these

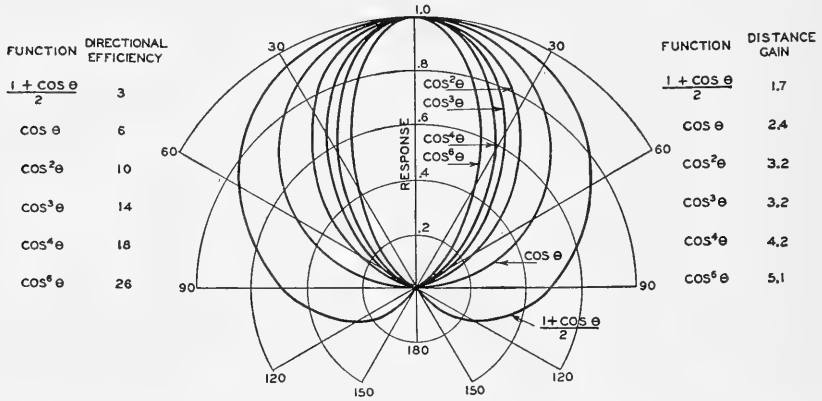

FIG. 9.41. The directional efficiency of microphones having directional characteristics which are various cosine functions. The ratio of energy response of a nondirectional microphone to the energy response of a directional microphone for sounds originating in random directions is termed directional efficiency. The ratio of the distance at which a directional microphone may be operated as compared to a nondirectional microphone is also shown.

functions are plotted in Fig. 9.41. The directional efficiency as outlined above is also given. For the same ratio of signal to noise, reverberation, etc., the directional microphone may be operated at  $\sqrt{\text{directional efficiency}}$  times distance of a nondirectional microphone. By means of the characteristics shown in Fig. 9.41, the efficiency of other characteristics may be obtained by comparing characteristics which have approximately the same shape and spread.

**9.7. Wind Excitation and Screening of Microphones.** — There are three possible sources of excitation which a microphone is subject to when placed in a wind. There may be pressure fluctuations due to velocity fluctuations present in the wind even though the microphone is absent. There may be pressure fluctuations due to turbulence produced by the microphone in a wind otherwise free from pressure fluctuations, that is, in a wind of uniform velocity. There may be radiation from the first two sources. The effect of the first source may be reduced by screening which takes advantage of the wind pressure distribution over the microphone, the

effect of the second by streamlining the microphone and the third is minimized by reductions in the first and second sources.

The customary wind screen<sup>36B</sup> consists of a frame covered with silk enclosing the microphone (Fig. 9.42B). Very sheer silk reduces the response to wind without appreciable attenuation of the sound. A spherical shape has been found to offer the best shielding properties. The shielding properties increase with the volume of the shield.

In general, the response to wind is much higher for directions normal to the diaphragm by applying the principles of hydrodynamics. A wind screen has been developed which reduces the wind response of the micro-

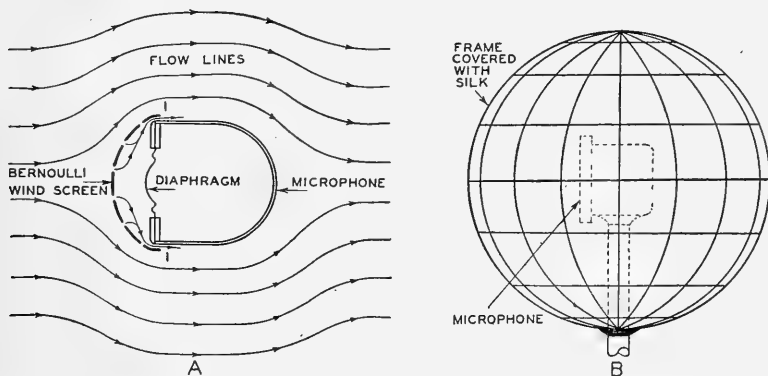

FIG. 9.42. Wind screens for microphones. *A*. Bernoulli wind screen applied to a dynamic microphone. *B*. Wind screen consisting of a wire frame covered with sheer silk.

phone. The Bernoulli<sup>37</sup> wind screen is shown in Fig. 9.42*A*. The wind pulses travel through the screen and exert a pressure on the diaphragm. These same pulses cause a reduction in pressure at the periphery 1. These two effects tend to balance each other and, therefore, the response to wind is reduced. This type of screen reduces the wind response about 12 db.

**9.8. Nonlinear Distortion in Microphones.** — The sources of distortion in microphones are, in general, the same as in the case of loud speakers. The two principal causes are due to nonlinear mechanical or acoustical elements and nonuniform magnetic field in dynamic types. The latter type of distortion can be made negligible in well-designed units. For example, in a velocity microphone the amplitude of the ribbon for a plane

<sup>36B</sup> Olson and Massa, "Applied Acoustics," P. Blakiston's Son and Co., Philadelphia.

<sup>37</sup> Phelps, W. D., *RCA Review*, Vol. 3, No. 2, p. 203, 1938.

wave of 100 dynes per square centimeter at 30 cycles is less than a millimeter. The distortion due to a variation in the field over this distance is less than  $\frac{1}{10}$  of a per cent. In the case of the velocity microphone the system is mass-controlled and there are no nonlinear elements. The measured distortion (see Sec. 11.2C) in a velocity microphone for sound pressures up to 1000 dynes per square centimeter is less than  $\frac{1}{3}$  of a per cent at 80 cycles. The most common source of nonlinear distortion in dynamic microphones originates in the suspension system. In some cases at the lower frequencies the harmonic distortion for a sound pressure of 100 dynes per square centimeter may be several per cent. This very high distortion is usually caused by instability of certain portions of the suspension due to dissymmetry of the corrugation and inhomogeneity of the material. As already pointed out, the distortion in carbon microphones is very high due to the nonlinear characteristics of granular contacts. Considerable improvement has been made in carbon materials in recent years and the distortion, although still high, has been materially reduced.

**9.9. Transient Response of Microphones.** — The subject of transient response of vibrating systems, together with applications to loud speakers has been considered in Sec. 7.16. The measurement of transient response of loud speakers will be considered in Sec. 11.3G. The transient response of a microphone may be predicted from the equivalent circuit by the use of the Operational Calculus.

In the case of the mass-controlled system of the velocity microphone the response to transients is very good. In the more complicated microphones, having vibrating systems of several degrees of freedom, the transient response may be very poor. This is particularly true of multiresonant systems with relatively low resistance.

**9.10. High Sensitivity Microphones (Motional Impedance).** — The considerations in this chapter have assumed the mechanical or acoustical impedance, due to the electrical system, to be small compared to the other mechanical or acoustical impedances of the vibrating system and may, therefore, be neglected. In all the high quality microphones discussed in this chapter these assumptions are satisfied. In the case of the batteryless telephones or other highly sensitive microphones the effect of the electrical system upon the vibrating system must be considered in order to predict the performance of the system. The discussions of Secs. 6.2 and 7.2 and Fig. 7.3 are of course applicable to the moving conductor, dynamic and ribbon microphones. The mechanical or acoustical impedance due to the electrical circuit is in series with the actuating force or pressure. In the equivalent circuit of the mechanical system of Fig. 7.3 the actuating force in

the sound wave is  $f_{M0}$  and the mechanical impedance due to the electrical circuit is  $z_{ME}$ . The effect of the electrical circuit upon the vibrating systems of other types of transducers, namely, electromagnetic, condenser and piezoelectric can be obtained from Chapter VI.

**9.11. Thermal Noise in Microphones.** — The smallest voltage that can be measured at the terminals of a resistance is limited by the voltage due to thermal agitation<sup>38,39</sup> of the electrons. The lower limit of sound intensities which may be measured with a dynamic, ribbon, inductor or magnetic microphone is the intensity at which the signal voltage is just equal to the voltage of thermal agitation.

The voltage, in volts, of thermal agitation is

$$e = \sqrt{4KT(f_2 - f_1)r_E} \times 10^{-7} \quad 9.75$$

where  $K$  = Boltzmann constant =  $1.37 \times 10^{-16}$  ergs per degree,  
 $T$  = absolute temperature, for 20° Centigrade  $T = 293$ ,  
 $f_2 - f_1$  = width of the frequency band, in cycles per second, and  
 $r_E$  = resistance of the element (coil, ribbon or conductor), in ohms.

For a microphone having a resistance of 250 ohms and a frequency band of 15,000 cycles the thermal voltage is  $2.5 \times 10^{-7}$  volts. The voltage delivered by a sensitive velocity or dynamic microphone at this impedance is  $3.0 \times 10^{-4}$  volts per dyne per square centimeter. The smallest pressure that can be measured with this microphone is  $0.8 \times 10^{-3}$  dynes per square centimeter. Referring to Fig. 13.1, this is about 20 db above the ear threshold of hearing at the most sensitive region.

<sup>38</sup> Johnson, J. B., *Phys. Rev.*, Vol. 32, No. 1, p. 97, 1928.

<sup>39</sup> Nyquist, H., *Phys. Rev.*, Vol. 32, No. 1, p. 110, 1928.

## CHAPTER X

### MISCELLANEOUS TRANSDUCERS

**10.1. Introduction.** — Interest in the science of sound reproduction has been stimulated during the past two decades by the almost universal use of the phonograph, radio and the sound motion picture. The two most important acoustical elements in electrical reproduction of sound are loud speakers and microphones. For this reason, considerable space has been given in this book to complete discussions of the most common instruments. There are innumerable electroacoustic, mechanoacoustic and electromechanoacoustic transducers in use to-day for all types of applications. In general, most of these can be reduced fundamentally to one of the systems described in Chapter VI. Therefore, the major portion of the applications discussed in this text will be confined to sound reproduction. In addition to loud speakers and microphones, the following transducers are in common use in certain types of sound reproduction: telephone receivers, mechanical phonographs, phonograph pickups, electrical musical instruments and hearing aids. It is the purpose of this chapter to consider typical examples of these transducers.

**10.2. Telephone Receivers.** — A telephone receiver is an electroacoustic transducer actuated by energy in the electrical system and supplying energy to an acoustic system.

A. *Bipolar Telephone Receiver.* — The bipolar telephone receiver is a telephone receiver in which the alternating force, due to the alternating current in the electromagnet, operates directly upon a diaphragm armature of steel. A cross-sectional view of a bipolar telephone receiver is shown in Fig. 10.1. The steel diaphragm is spaced a small distance from the pole pieces which are wound with insulated wire. A permanent magnet supplies the steady flux.

The force upon the diaphragm, in dynes, has been derived in Sec. 6.3*A*. The force from equation 6.9 is

$$f_M = \frac{M^2}{4\pi R_1^2 A} + \frac{2MNi_{\max} \sin \omega t}{R_1 R_2 A} + \frac{2\pi N^2 i_{\max}^2}{R_2^2 A} - \frac{2\pi N^2 i_{\max}^2 \cos 2\omega t}{R_2^2 A} \quad 10.1$$

where  $A$  = effective area of one pole, in square centimeters,  
 $N$  = number of turns per coil,  
 $R_1$  = reluctance of the permanent field circuit, in gilberts per maxwell,  
 $R_2$  = reluctance of the alternating magnetic circuit, in gilberts per maxwell,  
 $M$  = magnetomotive force of the magnet, in gilberts,  
 $i_{\max}$  = maximum current in the coil, in abamperes,  
 $\omega = 2\pi f$ ,  
 $f$  = frequency, in cycles per second, and  
 $t$  = time, in seconds.

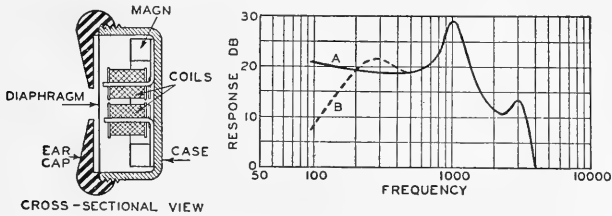

FIG. 10.1. Cross-sectional view of a bipolar telephone receiver. The graph shows the pressure response frequency characteristics. *A*. Receiver feeding a closed cavity. *B*. Receiver feeding an artificial ear.

The first and third term on the right-hand side of equation 10.1 represent a steady force, the second term represents a force of the same frequency and the last term represents a force of twice the frequency of the current in the coil. Equation 6.9 shows the necessity for the polarizing field  $\phi_1$  in order to obtain high sensitivity. Further,  $\phi_1$  must be large compared to  $\phi_2$  in order to reduce second harmonic distortion.

The diaphragm in the bipolar receiver is a circular plate clamped at the edge. See Sec. 3.5. The first resonance is usually placed at 1000 cycles. In the range below 1000 cycles the system is stiffness controlled.

If a telephone receiver is very carefully sealed to the ear so that no leakage occurs between the ear cap and the ear, the acoustic impedance presented to the telephone receiver by the ear is an acoustic capacitance. In order that the sound pressure be independent of the frequency under these conditions the ratio of the current to the amplitude must be independent of the frequency. The sound pressure delivered by a bipolar telephone receiver to a cavity as a function of the frequency is shown in Fig. 10.1. In the range below the resonance frequency of the diaphragm the response is independent of the frequency. At the first resonance frequency of the diaphragm the

response is very high. Above the resonance frequency the amplitude decreases rapidly with frequency. The peak at 3000 cycles is the second resonance frequency of the diaphragm.

The response frequency characteristic labeled *A*, Fig. 10.1, was obtained with no leak between the ear and the ear cap. In all hard ear caps a leak occurs between the ear and the telephone receiver and the acoustic impedance presented to the telephone receivers is considerably more complex than that of a capacitance of a small cavity. In the case of telephone receivers worn in the customary manner the acoustic impedance has three components, namely: the resistive and inertive components due to the leak between the ear cap and the ear and the acoustic capacitance due to the ear cavity. These factors will be considered in detail in the section on the testing of telephone receivers. See Sec. 11.4.

The response characteristic indicated as *B* in Fig. 10.1 was taken on an artificial ear which simulates the conditions encountered in actual practice. The artificial ear, see Sec. 11.4*B*, introduces a leak which corresponds to the leak between the ear and the ear cap. It will be seen that the effect of this leak is to reduce the response at the lower frequencies. Those familiar with telephone receivers have noticed that the low frequency response is increased when the leak is reduced by pressing the telephone receivers tightly against the ears.

Since the development of the bipolar telephone receiver by Alexander Graham Bell the construction has remained essentially the same. Improvements have been made in sensitivity and response by the use of better materials. However, the clamped plate diaphragm characterized by prominent resonant peaks was retained. Referring to Fig. 10.1, it will be seen that the peaks due to the first and second resonance fall within the response range. These resonances not only introduce frequency distortion, but increase the intensity of reproduction of clicks due to the poor transient response. See Sec. 7.16.

A new receiver<sup>1</sup> has been designed in which all the prominent resonances within the response range have been eliminated and the response frequency characteristic improved both from the standpoint of uniformity as well as from the frequency range. The new receiver is of the bipolar permanent magnet type. The magnetic circuit consists of pole pieces of 45 per cent Permalloy, two straight bar magnets of Remalloy and a Permandur diaphragm. The use of these materials increases the efficiency of the unit.

The equivalent electrical circuit of the mechanical system is shown in

---

<sup>1</sup> Jones, W. C., *Jour. A.I.E.E.*, Vol. 57, No. 10, p. 559, 1939.



Fig. 10.2. The mass of the diaphragm is represented by  $m_0$ . The compliance and mechanical resistance of the diaphragm are designated as  $C_{M0}$  and  $r_{M0}$ . The back of the diaphragm is enclosed, forming the compliance  $C_{M1}$  due to the resulting cavity. This cavity is connected to the recess in the receiver handle by a hole in the plate. A special silk covers this hole, forming the mechanical resistance  $r_{M1}$  and the mass  $m_1$ . The

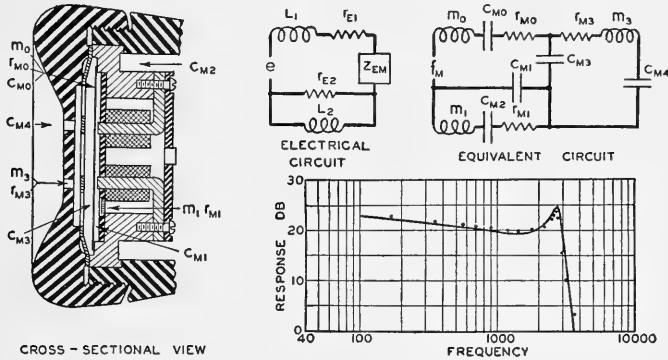

FIG. 10.2. Cross-sectional view, electrical circuit, and equivalent circuit of an improved bipolar telephone receiver. The graph shows the pressure response frequency characteristic of the receiver feeding a closed cavity. The dots represent response computed from equivalent circuit. (After Jones.)

volume due to the recess in the receiver handle forms the compliance  $C_{M2}$ . The holes in the ear cap form the mechanical resistance  $r_{M3}$  and the mass  $m_3$ . The compliance  $C_{M3}$  is due to the cavity between the ear cap and the diaphragm. The response of this receiver was taken by measuring the pressure generated in a plain cavity. This cavity is designated by the compliance  $C_{M4}$ . The holes in the grid covering the receiver proper are large enough to have no reaction upon the response. A resilient screen of silk is mounted on the back of this grill. The mass of this screen is very small and is lumped with the diaphragm mass  $m_0$ .

The electrical portion of the circuit consists of the winding resistance  $r_{E1}$  and inductance  $L_1$ . The eddy current elements are designated as  $r_{E2}$  and  $L_2$ . The electrical impedance due to the mechanical system is designated by the motional impedance  $z_{EM}$ . See Sec. 6.3A and equation 6.19. The force  $f_M$  can be obtained from equation 10.1.

The response computed by means of the equivalent electrical circuit is shown by the dots on the graph of Fig. 10.2. The measured response is given by the curve on this graph. The agreement is very good and shows

that it is possible to predetermine the response and to evaluate the effect of changes in the constants of the component parts. Comparing the response of Figs. 10.1 and 10.2 it will be seen that large gains have been effected in uniform response over the entire range and in sensitivity from 1500 to 3000 cycles.

*B. Crystal Telephone Receiver.* — A crystal telephone receiver<sup>2</sup> consists of a light diaphragm connected to a Rochelle salt crystal, Fig. 10.3. The crystal as a driving system was considered in Sec. 6.5. The three corners of a “bender” crystal are fastened to the case. The fourth corner is is

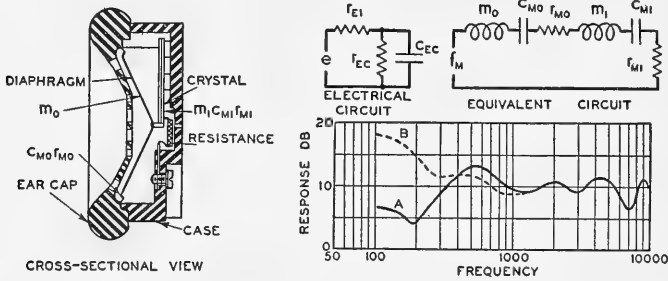

FIG. 10.3. Cross-sectional view, electric circuit and equivalent circuit of the mechanical system of a crystal telephone receiver. In the electrical circuit:  $e$  the voltage of the generator.  $r_{E1}$  the resistance of the generator plus the external series resistance.  $r_{EC}$  and  $C_{EC}$  the resistance and electrical capacitance of the crystal. In the equivalent circuit:  $m_0$  the mass of the diaphragm.  $C_{M0}$  and  $r_{M0}$  the compliance and mechanical resistance of the suspension.  $m_1$ ,  $C_{M1}$  and  $r_{M1}$  the mass, compliance and mechanical resistance of the crystal.  $f_M$  the force generated in the crystal. The graph shows the pressure response frequency characteristic. *B.* Receiver feeding a closed cavity. *A.* Receiver feeding an artificial ear. (After Williams.)

fastened to the diaphragm. The impedance of a crystal telephone is primarily a capacitive reactance. Because of this fact the low frequency response may be raised relative to the high frequency response by connecting a high resistance in series with the receivers. A high resistance must be used because the impedance of the crystal is very high, being 80,000 ohms at 10,000 cycles.

A response frequency characteristic feeding a plain cavity (acoustic capacitance) is indicated by *B*, Fig. 10.3. The response frequency characteristic taken on an artificial ear is indicated by *A*, Fig. 10.3.

*C. Dynamic Telephone Receiver.* — A dynamic telephone receiver<sup>3</sup> consists of a light diaphragm coupled to a voice coil and a suitable acoustical

<sup>2</sup> Williams, A. L., *Jour. Soc. Mot. Pic. Eng.*, Vol. 32, No. 5, p. 552, 1939.

<sup>3</sup> Wentz and Thurax, *Jour. Acous. Soc. Amer.*, Vol. III, No. 1, p. 44, 1932.

network for controlling the response. A cross-sectional view of a typical dynamic telephone receiver is shown in Fig. 10.4. The equivalent electrical circuit of the mechanical system is also shown in Fig. 10.4.

The electrical impedance, in abohms, due to the mechanical system is given by

$$z_{EM} = \frac{Bl}{z_M} \tag{10.2}$$

where  $B$  = flux density in the air gap, in gaussses,  
 $l$  = length of the conductor in the voice coil, in centimeters, and  
 $z_M$  = total mechanical impedance at  $f_M$ , in mechanical ohms.

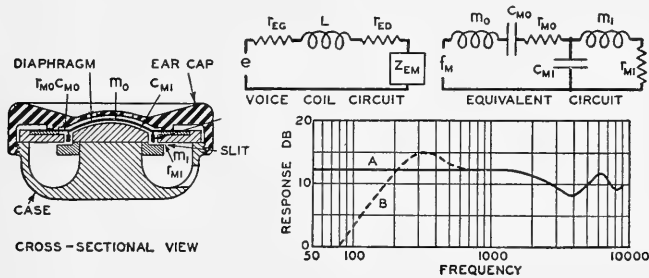

FIG. 10.4. Cross-sectional view, the voice coil circuit and the equivalent circuit of the mechanical system of a dynamic telephone receiver.  $e$  the voltage of the generator.  $r_{EG}$  the resistance of the generator.  $r_{ED}$  the damped resistance of the voice coil.  $L$  the inductance of the voice coil.  $z_{EM}$  the motional impedance. In the equivalent circuit:  $m_0$  the mass of the diaphragm.  $C_{M0}$  and  $r_{M0}$  the compliance and mechanical resistance of the suspension.  $m_1$  and  $r_{M1}$  the mass and mechanical resistance of the slit.  $C_{M1}$  the compliance of the cavity behind the diaphragm.  $f_M$  the force generated in the voice coil. The graph shows the pressure response frequency characteristic.  $A$ . Receiver feeding a closed cavity.  $B$ . Receiver feeding an artificial ear. (After Wentz and Thurax.)

In dynamic telephone receivers the flux density is relatively low and  $z_{EM}$  is small compared to  $r_{ED}$  and may be neglected.

The force  $f_M$ , in dynes, is given by

$$f_M = Bli \tag{10.3}$$

where  $i$ , the current in abamperes, is obtained from the electrical circuit. In general, the force  $f_M$  is practically a constant and may be considered a constant in the equivalent circuit.

The response feeding a plain cavity is indicated by  $A$ , Fig. 10.4. The response measured on an artificial ear indicated by  $B$ , Fig. 10.4, shows that the response at the low frequencies is reduced due to the leak.

D. *Inductor Telephone Receiver*<sup>4, 5, 5A</sup>. — The effect of the leak between the ear and the ear cap upon the response of a telephone receiver has been outlined in the preceding sections. Obviously, from a practical standpoint the performance of a telephone receiver should be independent of the leak between the ear and the ear cap. In order to design the vibrating system of the telephone receiver so that constant sound pressure will be delivered

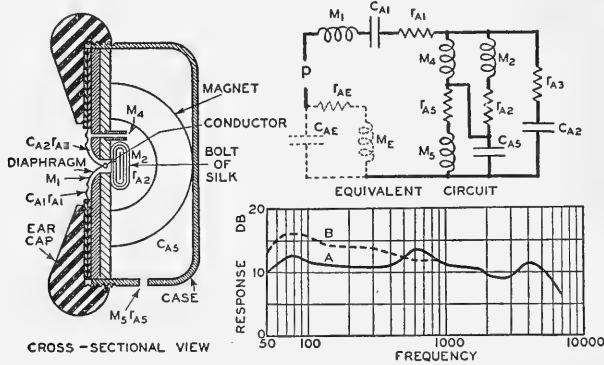

FIG. 10.5. Cross-sectional view and equivalent circuit of the acoustical system of an inductor telephone receiver. In the equivalent circuit  $M_1$  the inductance of the diaphragm and conductor.  $C_{A1}$  and  $r_{A1}$  the acoustic capacitance and acoustic resistance of the diaphragm suspension.  $M_2$  and  $r_{A2}$  the inductance and acoustic resistance of the bolt of silk.  $C_{A2}$  and  $r_{A3}$  the acoustic capacitance and acoustic resistance of the cavity behind the diaphragm.  $M_4$  the inductance of the tube.  $C_{A5}$  the acoustic capacitance of the case volume.  $M_5$  and  $r_{A5}$  the inductance and acoustic resistance of the hole in the case.  $M_E$  and  $r_{A_E}$  and  $C_{A_E}$  the inductance, acoustic resistance and acoustic capacitance of the ear.  $p$  the driving pressure.  $p$  is  $f_M$  divided by the area of the diaphragm. The graph shows the pressure response frequency characteristic. B. Receiver feeding a closed cavity. A. Receiver feeding an artificial ear.

to the ear, the nature of the acoustic impedance looking through the aperture of the ear cap must be considered as a part of the vibrating system. The impedance characteristic, looking through the aperture of the ear cap of a telephone receiver, is shown in Fig. 11.15, Sec. 11.4B. These characteristics show that the impedance is positive and increases with frequency up to 400 cycles; between 300 and 500 cycles it is practically resistive and above 400 cycles it is negative and decreases with frequency. A generalization of the requirements for maintaining constant sound pres-

<sup>4</sup> Olson and Massa, *Jour. Acous. Soc. Amer.*, Vol. 6, No. 4, p. 240, 1935.

<sup>5</sup> Olson, H. F., *Jour. Soc. Mot. Pic. Eng.*, Vol. 27, No. 5, p. 537, 1936.

<sup>5A</sup> Olson and Massa, "Applied Acoustics," P. Blakiston's Son and Co., Philadelphia.

sure in the ear cavity under these conditions is as follows: the velocity of the diaphragm below 300 cycles must be inversely proportional to the frequency; between 300 cycles and 500 cycles the velocity should be independent of the frequency and above 500 cycles the velocity should be proportional to the frequency.

The equivalent circuit of a telephone receiver which delivers practically uniform sound pressure to the ear cavity in the presence of a normal leak is shown in Fig. 10.5. The equivalent circuit of the ear is shown dotted. The "V" shaped diaphragm is driven by a straight conductor located in the bottom of the "V." The electrical circuit is the same as in the case of the dynamic telephone receiver. The pressure  $p$  may be considered to be independent of the frequency.

The response frequency characteristic taken on an artificial ear is indicated by  $A$ , Fig. 10.5. The constants were chosen to give the smoothest response between 60 and 7000 cycles. The response frequency characteristic with the receivers feeding a plain cavity is indicated by  $B$ , Fig. 10.5. The small difference between the response with and without a leak indicates the effectiveness of this type of vibrating system in minimizing the effect of the leak between the ear and the ear cap.

**10.3. Phonographs.** — A phonograph is a system for the reproduction of sound from a record. To-day, a phonograph usually refers to a system in which a stylus (needle) follows the undulations in the groove of a record and transforms these undulations into the corresponding acoustic or electrical variations. The record may take the form of a cylinder or a flat disk. To-day, the flat disk record is almost universally used for entertainment while the cylindrical record is used for dictographs. In the hill and dale or vertical type record the undulations are cut in a direction normal to the surface. In the lateral record the undulations are cut in a direction parallel to the surface of the record. The lateral records are used for home reproduction. Both vertical and lateral records are used for high quality reproductions as, for example, in transcriptions for broadcasting. The systems used in the recording and processing of phonograph records will be considered in Sec. 12.4*F*. It is the purpose of the sections which follow to consider a mechanical phonograph, phonograph pickups and distortion in phonograph reproduction.

*A. Mechanical Phonograph*<sup>6</sup>. — A mechanical phonograph is a mechano-acoustic transducer actuated by a phonograph record and by means of an acoustical system radiates acoustic energy into a room or open air. A

---

<sup>6</sup> Maxfield and Harrison, *Bell Syst. Tech. Jour.*, Vol. 5, No. 3, p. 493, 1926.

cross-sectional view and the equivalent circuit of a mechanical phonograph is shown in Fig. 10.6. The system consists essentially of a diaphragm  $m_3$  coupled to a needle  $C_{M1}$  driven by a phonograph record. To improve the radiation efficiency, the diaphragm is coupled to the horn  $Z_{MH}$ . The record mechanical  $Z_{MR}$  impedance is usually large compared to the impedance of the remainder of the system save at the high frequencies. The record

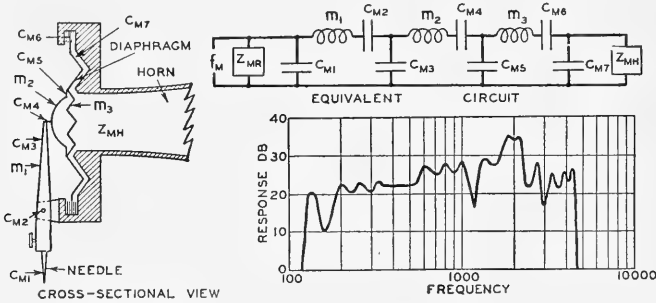

FIG. 10.6. Cross-sectional view and equivalent circuit of a mechanical phonograph. In the equivalent circuit:  $Z_{MR}$  the mechanical impedance of the record.  $C_{M1}$ ,  $C_{M2}$ ,  $C_{M3}$ ,  $C_{M4}$ ,  $C_{M5}$ ,  $C_{M6}$ , and  $C_{M7}$  the compliances of the needle, the needle holder arm pivot, the needle holder arm, the connector, the spider, the suspension and the air chamber.  $m_1$ ,  $m_2$  and  $m_3$  the mass of the needle holder arm, the spider and the diaphragm.  $Z_{MH}$  the impedance at the throat of the horn.  $f_M$  the force generated by a constant velocity generator. The graph shows the pressure response frequency characteristic of a console type mechanical phonograph. (After Maxfield and Harrison.)

mechanical impedance is a function of the type of material. Obviously, it is higher for the harder materials. The generator in the equivalent circuit of this system is of the constant current type. That is,  $f_M$  delivers constant velocity to the equivalent circuit. That is, the velocity is independent of the impedance of the load.

The velocity response frequency characteristic of a typical phonograph record for constant voltage input into the microphone amplifier (see Sec. 12.4F) is shown in Fig. 10.7. To prevent overcutting the groove the system is compensated so that the amplitude for constant input is essentially independent of the frequency below 500 cycles. Therefore, the velocity under these conditions falls off 6 db per octave below 500 cycles. From this characteristic and the equivalent circuit, the performance of the system may be determined.

The response frequency characteristic of a mechanical phonograph of the console type is shown in Fig. 10.6.

B. *Phonograph Pickup*. — A phonograph pickup is an electromechanical

transducer actuated by a phonograph record and delivering energy to an electrical system, the electrical current having frequency components corresponding to those of the wave in the record. The systems for converting the mechanical vibrations into the corresponding electrical variations are

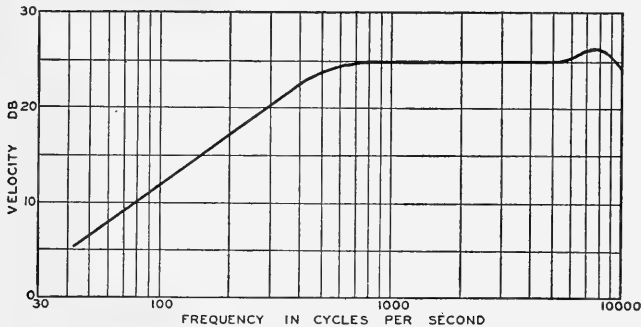

FIG. 10.7. Velocity response frequency characteristic of a phonograph record with constant voltage applied to an equalized recording amplifier.

as follows: magnetic, carbon contact, condenser, dynamic and crystal. It is the purpose of this section to consider examples of some of the most common phonograph pickups in use to-day.

1. *Crystal Pickup.* — A crystal pickup<sup>7</sup> is a phonograph pickup which depends for its operation on the piezoelectric effect. The crystal in use to-day is Rochelle salt. A cross-sectional view of a typical crystal pickup used in commercial phonographs is shown in Fig. 10.8. The needle, driven by the record, is coupled to the crystal. The elements of the system and the equivalent electrical circuit are shown in Fig. 10.8. The displacement of the crystal can be determined from the equivalent electrical circuit of the mechanical system and the velocity of the generator obtained from Fig. 10.7. The voltage output of the crystal is proportional to the displacement. Therefore, the open circuit voltage at the low frequencies is accentuated as shown by the response characteristic *A*, Fig. 10.8. The internal electrical impedance of the crystal increases with the decrease in frequency since the crystal is essentially an electrical capacitance. The open circuit voltage characteristic renders the low frequency compensation problem exceedingly simple. The response frequency characteristic of a pickup with a resistance shunting the crystal is indicated by *B*, Fig. 10.8. The high frequency response of the crystal shows a cutoff around 7000

<sup>7</sup> Williams, A. L., *Jour. Soc. Mot. Pic. Eng.*, Vol. 32, No. 5, p. 552, 1939.

cycles. This cutoff can be made any value up to 15,000 cycles by a suitable choice of constants.

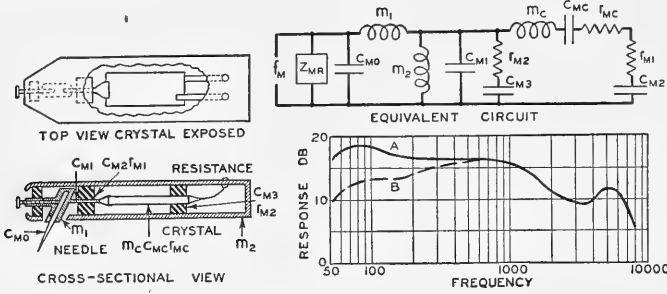

FIG. 10.8. Cross-sectional view and equivalent circuit of the mechanical system of a crystal pickup. In the equivalent circuit:  $Z_{MR}$  the mechanical impedance of the record.  $C_{M0}$  the compliance of the needle.  $m_1$  the mass of the needle holder.  $C_{M1}$  the compliance of the shaft.  $C_{M2}f_{M1}$  and  $C_{M3}f_{M2}$  the compliances and mechanical resistances of the crystal supports.  $m_C$ ,  $C_{Mc}$  and  $r_{Mc}$  the mass, compliance and mechanical resistance of the crystal.  $m_2$  the mass of the pickup and tone arm.  $f_M$  the force generated by a constant velocity generator. The graph shows the voltage response characteristics with the record characteristic of Fig. 10.7. *A*. Open circuit response characteristic. *B*. Response characteristic with 500,000 ohms shunting the crystal.

2. *Magnetic Pickup.* — A magnetic pickup<sup>8,9</sup> is a phonograph pickup whose electrical output is generated in a coil or conductor in a magnetic field or circuit. A typical magnetic pickup is shown in Fig. 10.9. The

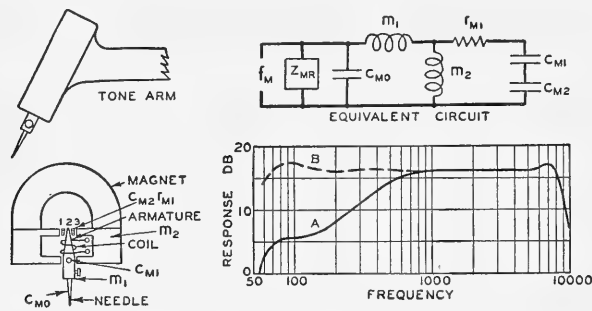

FIG. 10.9. Magnetic pickup and the equivalent circuit of the mechanical system. In the equivalent circuit:  $Z_{MR}$  the mechanical impedance of the record.  $C_{M0}$  the compliance of the needle.  $m_1$  the mass of the needle holder and armature.  $C_{M1}$  the compliance of the needle holder pivot.  $C_{M2}$  and  $r_{M1}$  the compliance and mechanical resistance of the damping material.  $m_2$  the mass of the pickup and tone arm.  $f_M$  the force generated by a constant velocity generator. The graph shows the voltage response frequency characteristics. *A*. Response with the record characteristic of Fig. 10.7. *B*. Equalized response characteristic.

<sup>8</sup> Kellogg, E. W., *Four. A. I. E. E.*, Vol. 46, No. 10, p. 1041, 1927.  
<sup>9</sup> Hasbrouck, H. J., *Proc. I. R. E.*, Vol. 27, No. 3, p. 184, 1939.



motion of the needle is transferred to the armature. The steady flux is furnished by a permanent magnet. The armature is of the balanced type so that in its central position there is no flux through the armature. When the armature is deflected, a flux flows through the armature which induces a voltage in the coil. Assume that the armature is deflected a distance  $\Delta x$ . The flux, in maxwells, through the path 1, 2, assuming all the reluctance resides in the air gap, is

$$\phi_{12} = \frac{M}{2(a - \Delta x)} \tag{10.4}$$

where  $M$  = magnetomotive force of the magnet, in gilberts,  
 $a$  = spacing between the armature and the pole, in centimeters, and  
 $\Delta x$  = deflection from the central position, in centimeters.

The flux through the path 2, 3 under these conditions is

$$\phi_{23} = \frac{M}{2(a + \Delta x)} \tag{10.5}$$

The flux, in maxwells, through the armature is

$$\Delta\phi = \phi_{12} - \phi_{23} = \frac{M\Delta x}{a^2 - (\Delta x)^2} \doteq \frac{M\Delta x}{a^2} \tag{10.6}$$

If the displacement  $\Delta x$  takes place in the time  $\Delta t$ , then the rate of change of flux with respect to time, is

$$\frac{\Delta\phi}{\Delta t} = \frac{M}{a^2} \frac{\Delta x}{\Delta t} \tag{10.7}$$

In the limit

$$\frac{d\phi}{dt} = \frac{M}{a^2} \frac{dx}{dt} = \frac{M}{a^2} \dot{x} \tag{10.8}$$

The voltage in abvolts, generated in the coil is

$$e = N \frac{d\phi}{dt} = \frac{NM}{a^2} \dot{x} \tag{10.9}$$

where  $N$  = number of turns in the coil.

Equation 10.9 shows that the generated voltage will be independent of the frequency if the velocity of the armature is independent of the frequency.

The equivalent circuit of the mechanical system is shown in Fig. 10.9. Damping, represented by the compliance  $C_{M2}$  and the mechanical resistance  $r_{M1}$ , is furnished by a suitable material such as viscoloid. The re-

sponse frequency characteristic with record characteristic shown in Fig. 10.7 is shown in Fig. 10.9. The output below 1000 cycles is similar to that of the record. Some compensation in the amplifier must be provided to compensate for this drooping characteristic. The peak at the low frequencies is due to the resonance of the total mass of the pickup and tone arm  $m_2$  with the compliances  $C_{M1}$  and  $C_{M2}$ . Below this resonance frequency the mass reactance due to  $m_2$  becomes small compared to the impedance of the compliance elements and the output falls off rapidly with decrease in frequency.

3. *Dynamic Pickup*. — A dynamic pickup is a phonograph pickup in which the output results from the motion of a conductor in a magnetic

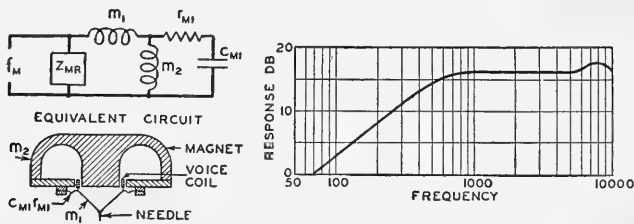

FIG. 10.10. Cross-sectional view and equivalent circuit of the mechanical system of a dynamic pickup. In the equivalent circuit:  $z_{MR}$  the mechanical impedance of the record.  $m_1$  the mass of the needle and voice coil.  $C_{M1}$  and  $r_{M1}$  the compliance and mechanical resistance of the suspension system.  $m_2$  the mass of the pickup and tone arm.  $f_M$  the force generated by a constant velocity generator. The graph shows the voltage response characteristic with the record characteristic of Fig. 10.7.

field. Fig. 10.10 shows a cross-sectional view of a dynamic pickup<sup>10</sup> for the reproduction of hill and dale records. The principal mechanical impedance is due to the mass of the needle and coil. The output of the coil is proportional to the velocity. Therefore, the response characteristic is similar to that of the magnetic pickup.

C. *Distortion in Record Reproduction*<sup>11,12</sup>. — The recording and reproducing of a phonograph record is a complicated process and there are many sources of nonlinear distortion. The record does not present an infinite impedance to the needle. As a consequence, the vibrating system of the pickup is shunted by the effective mechanical impedance of the record at the needle. Nonlinear distortion will be introduced if the record is a variable element.

<sup>10</sup> Frederick, H. A., *Four. Soc. Mot. Pic. Eng.*, Vol. 18, No. 2, p. 141, 1932.

<sup>11</sup> Di Toro, M. J., *Four. Soc. Mot. Pic. Eng.*, Vol. 29, No. 5, p. 493, 1938.

<sup>12</sup> Pierce and Hunt, *Four. Acous. Soc. Amer.*, Vol. 10, No. 1, p. 14, 1938.

Another source of nonlinear distortion is due to a deviation in tracking,<sup>13</sup> commonly termed tracking error. The angle between the vertical plane containing the vibration axis of the pickup and the vertical plane containing the tangent to the record is a measure of the tracking error. If the vibration axis of the pickup passes through the tone arm pivot, the tracking can be zero for only one point on the record. The tracking error can be reduced for the entire record if the vibration axis of the pickup is set at an appropriate angle with the line connecting the needle point and if the length of the tone arm is suitably matched to the distance between the tone arm pivot and the record axis. For a tracking error of  $15^\circ$  the distortion is approximately 4 per cent. However, by the above expedient the tracking error can be reduced to  $\pm 5^\circ$ . With this tracking error the distortion is negligible.

Another source of nonlinear distortion is due to the finite size of the stylus or needle point. The curve traced by the center of the needle sliding in a sinusoidal groove is not sinusoidal. This distortion may be reduced by reducing the size of the needle point. It is interesting to note that this distortion is greater in vertical cut records than in lateral. The push-pull effect of the lateral record tends to reduce the second harmonic distortion.

Another source of distortion is due to the lack of correspondence between the linear groove speed in the recording and ultimate reproduction. This type of distortion is termed "wows." This may be due to a nonuniform speed of the record turntable during recording or reproduction, misplacement of the center hole or configuration distortion during the processing. In general, the major source of "wows" is due to nonuniform speed of the reproducing turntable.

The record surface noise, in the absence of any signal, is one of the factors which limits the volume range and the frequency range of phonograph records. The amount of surface noise for a given record is proportional to the frequency band width. In order to reduce the surface noise to a tolerable value it is usually necessary to limit the high frequency range. A method for decreasing the effective surface noise consists of increasing the amplitude of the high frequency response in recording and introducing complementary equalization in reproduction. The volume range of a phonograph record, in general, does not permit recording the full range of a symphony orchestra without some compression. To offset this compression complementary expansion may be introduced in the reproduction.

---

<sup>13</sup> Olney, Benj., *Electronics*, Vol. 10, No. 1, p. 19, 1937.

**10.4. Electrical Musical Instruments**<sup>14</sup>. — The vacuum tube oscillator and amplifier has opened an entirely new field for the production of sound of practically any frequency, quality or amplitude. Many musical instruments employing various types of vibrating systems and associated vacuum tube oscillators and amplifiers have been developed.

The simplest system for the amplification of string instruments like violins, guitars, banjos, pianos, etc., consists of a vibration pickup attached to the body or sounding board, an amplifier and a loud speaker.

Electric pianos<sup>15</sup> have been developed in which the vibrations of the strings are converted into the corresponding electrical variations. In one system, the variation in capacity between the string and an insulated plate is used in a manner similar to the condenser microphone. In another, the string acts as an armature in an electromagnetic system. The outputs of the pickup systems are amplified and reproduced by means of loud speakers.

One type of electric organ<sup>16</sup> consists of a number of small alternators (one for each note), a keying and mixing system for adjusting the quality, an amplifier and a loud speaker. Another electric organ<sup>17</sup> employs wind driven reeds. The vibrations of the reeds are converted into the corresponding electrical variations, amplified and reconverted into sound by means of loud speakers.

A versatile electronic musical instrument<sup>18,18A</sup> in which the wave shape and harmonic content may be varied over wide limits derives the needed frequencies from twelve high frequency oscillators followed by cascade frequency dividers in which the frequency is divided in each stage. The overtone structure of each note is made a function of the input level by the use of an over-biased nonlinear amplifier. Practically any musical instrument such as the organ, piano, guitar, violin, trombone, etc., can be simulated by this instrument.

Electric carillons<sup>19</sup> consisting of tuned coiled vibrators, magnetolectric translators, amplifiers and reproducers possess qualities which are quite similar to the conventional carillons.

The voder<sup>20</sup> is an electrical arrangement which corresponds to the mech-

<sup>14</sup> For a comprehensive paper on "Electronic Music and Instruments," Miessner, B. F., *Proc. I. R. E.*, Vol. 24, No. 11, p. 1427, 1936.

<sup>15</sup> Miessner, B. F., *Proc. I. R. E.*, Vol. 24, No. 11, p. 1427, 1936.

<sup>16</sup> Hammond, L., U. S. Patent 1,956,350.

<sup>17</sup> Hoschke, U. S. Patent 2,015,014.

<sup>18</sup> Hammond, L., *Science*, Vol. 89, p. 6, Feb. 10, 1939.

<sup>18A</sup> Hammond, L., *Electronics*, Vol. 12, No. 11, p. 16, 1939.

<sup>19</sup> Curtiss, A. N., U. S. Patent 2,026,342.

<sup>20</sup> *Bell Laboratories Record*, Vol. 17, No. 6, Feb., 1939.

anism of human speech in all the essentials of kinds of sound and of the completeness of control. In the voder there is an electrical source of sound corresponding to the vocal cords. These are the vowel sounds. This is a relaxation oscillator which gives a saw-tooth wave of definite pitch. Another source of sound supplies the consonants. By means of keys coupled to filters and attenuators the operator can simulate the sounds of speech.

**10.5. Hearing Aids<sup>21, 22</sup>.** — Tests made upon representative cross sections of the people in this country show a very large percentage to be hard of hearing. Practically all of these people may obtain satisfaction from the use of a hearing aid. A hearing aid is a complete reproducing system which increases the sound pressure over that normally received by the ear.

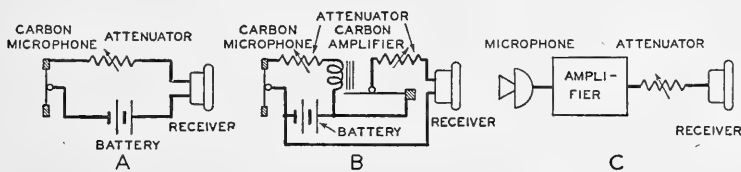

FIG. 10.11. Hearing Aids. *A*. Simple hearing aid. *B*. Hearing aid with a carbon amplifier. *C*. Arrangement of the components of a vacuum tube hearing aid.

The simplest hearing aid consists of a carbon microphone, a battery, an attenuator and a telephone receiver, Fig. 10.11*A*. This hearing aid will give satisfactory service where the hearing loss is about 20 db.

The hearing aid shown in Fig. 10.11*B* consists of a carbon microphone, carbon amplifier, an attenuator, a battery and a telephone receiver. This hearing aid will give satisfactory service where the hearing loss is about 40 db.

The quality of the carbon type hearing aids is usually very poor, due to the frequency and the amplitude distortion produced by the carbon microphone and amplifier.

During the past few years considerable attention has been directed toward hearing aids employing vacuum tube amplifiers. The schematic arrangement of the components of a vacuum tube hearing aid is shown in Fig. 10.11*C*. The quality is far superior to that of the carbon type. Furthermore, suitable compensation circuits may be incorporated to complement the ear characteristics. At the present time the vacuum tube hearing

<sup>21</sup> Tuffnell, W. L., *Bell Labs. Record*, Vol. 18, No. 1, p. 8, 1939.

<sup>22</sup> Hawley, W. C., *Bell Labs. Record*, Vol. 18, No. 1, p. 12, 1939.

aids are considerably larger in size and weight and are more costly to operate than the carbon type.

The air conduction receiver is shown in Fig. 10.12*A*. A molded plug fits the ear cavity and holds the receiver in place. Due to the small size and method of mounting, the receiver is quite inconspicuous.

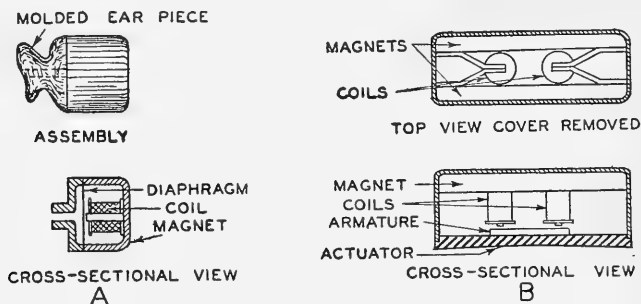

FIG. 10.12. Hearing aid telephone receivers. *A*. Air conduction receiver. *B*. Bone conduction receiver.

In certain types of deafness, the middle ear, which consists of a series of bones that conduct the sound to the inner ear, is damaged while the inner ear, consisting of the nerves, is normal. Under these conditions sound vibrations may be transmitted through the bones of the head to the inner ear by means of a bone conduction receiver, Fig. 10.12*B*. Usually the face of the receiver is placed against the mastoid bone behind the ear.

**10.6. Sirens<sup>23</sup> (Compressed Air Loud Speakers).** — The simplest siren consists of a revolving disk perforated with a ring of equally spaced holes which interrupt a jet of air from a tube placed close to one side of the disk. The fundamental frequency of the successive puffs of air issuing through the holes is equal to the product of the number of holes and the revolutions per second of the disk. The wave form, of course, depends upon the shape of the holes in the disk and the shape of the projection of the air tube upon the disk. The pressure of the air supply in large sirens is usually very high, of the order of 100 pounds per square inch. In the smaller sirens the air pressure is supplied by a single stage centrifugal pump and the supply pressure is of the order of a pound per square inch. Small sirens are used by police cars, ambulances and fire engines for signalling the approach of these vehicles. Large power sirens are used on firehouses, lighthouses and lightships.

<sup>23</sup> Wood, "A Textbook of Sound," Macmillan Co., New York.

The compressed air loud speaker consists of an electrically actuated valve which interrupts or modulates an air stream. Thus, the output consists of a series of puffs, the envelope of which corresponds to electrical impulses which actuate the valve. Horns are usually coupled to the system to improve the efficiency. In these systems the sound power output may be several times the electrical input to the valve. As a consequence, it is possible to obtain very large acoustical outputs with relatively small electrical inputs (small power amplifiers).

**10.7. Supersonics**<sup>24, 25</sup>. — Supersonics, in general, refers to acoustic waves of a frequency higher than those which may be heard by the ear (about 20,000 cycles). Supersonic frequencies are used for directional signalling in water, location of the depth of the ocean bed by the echo method, as a light valve in television projection and various other applications. It is beyond the scope of this book to consider the subject of supersonics.

Piezoelectric and magnetostriction oscillators are the systems most used for the production and reception of supersonic waves. Piezoelectric microphones and telephone receivers have been considered in Chapters IX and X. Piezoelectric supersonic generators and microphones usually employ either Rochelle salt or quartz crystals. Magnetization of magnetic materials such as iron, nickel and nickel alloys produces a small change in the dimensions. A rod of these materials surrounded by a coil carrying an alternating current will experience a change in length corresponding to the magnetic field produced by the coil. If the frequency corresponds to one of the resonant frequencies of the rod, the amplitude of the resulting vibrations will be relatively large. The same system may be used for a microphone.

The Galton whistle is another means of generating supersonics in air. Sounds of frequencies up to 100,000 cycles per second have been generated by the Galton whistle.

**10.8. Seismic Detectors**<sup>26</sup>. — The variation of the velocity of sound in the various strata comprising the earth's crust forms the basis of geophysical investigations in prospecting for oil. The detonation of a charge of dynamite creates an acoustic wave which is reflected from the various strata of the earth's surface. These reflected waves are picked up by microphones connected to recording oscillographs and located in strategic positions on the earth's surface. From the geometrical configuration of the apparatus, the oscillograph record, and the velocity of sound in various

---

<sup>24</sup> Bergmann, "Ultrasonics," G. Bell and Sons, Ltd., London.

<sup>25</sup> Olson and Massa, "Applied Acoustics," P. Blakiston's Son and Co., Philadelphia.

<sup>26</sup> Silverman, Daniel., *Jour. A.I.E.E.*, Vol. 58, No. 11, p. 455, 1939.

types of strata, the confirmation of the various strata may be determined. Oil pools are located in curved strata termed by geologists as anticlines. The presence of anticlines may be determined from seismic measurements.

Magnetic, carbon, crystal, condenser and dynamic microphones have been used for detectors. The large amplitude frequency components of seismic waves are usually confined to the lower frequencies. Therefore, the response of the microphone is confined to the range below 100 cycles. For these applications a magnetic microphone having a system similar to the reed type, Fig. 6.1, has been found to be very satisfactory. The armature is usually made massive and the stiffness small in order to obtain high sensitivity in the low frequency range. The microphone is placed directly upon the earth's surface. The microphone proper then vibrates with the earth's surface. The massive armature opposes any change from its position of rest. As a consequence, there is relative motion between the armature and the microphone proper which results in the production of a voltage corresponding to the vibrations of the earth's surface. By suitable orientation, the microphone can be made responsive to only vertical vibrations. As a consequence, the wave transmitted directly through the earth is not reproduced.



## CHAPTER XI

### MEASUREMENTS

**11.1. Introduction.** — The rapid progress made in acoustics during the past two decades has resulted in a corresponding advance in acoustical measurements. In applied acoustics, as in any applied science, theoretical analysis and analytical developments are substantiated by experimental verifications. In view of the importance of acoustical measurements, it seems logical to devote a portion of this book to that phase of acoustics. It is the purpose of this chapter to consider the testing of microphones, loud speakers and telephone receivers together with fundamental acoustical measurements.

**11.2. Calibration of Microphones**<sup>1,2</sup>. — A number of different measurements are required to determine the performance of a microphone. The most important characteristics which depict the performance of a microphone are as follows:

1. Response frequency characteristic.
2. Directional characteristic.
3. Nonlinear distortion characteristic.
4. Phase distortion characteristic.
5. Transient response characteristic.
6. Electrical impedance characteristic.

In addition to the above characteristics are such factors as the effect of temperature, humidity and changes in atmospheric pressure upon the performance of the microphone. Carbon microphones exhibit characteristics peculiar to granular contacts such as carbon noise, packing and breathing.

#### A. *Response Frequency Characteristic.*

1. *Pressure Response.* — The pressure response frequency characteristic of a microphone is the ratio  $e/p$  as a function of the frequency where  $e$  is the open circuit voltage generated by the microphone in volts and  $p$  is the sound pressure in dynes per square centimeter upon the diaphragm of the

---

<sup>1</sup> American Standards Association Sectional Committee z-24, Report on, Calibration of Microphones, *Jour. Acous. Soc. Amer.*, Vol. 7, No. 4, p. 33, 1936.

<sup>2</sup> Standards of the Institute of Radio Engineers, 1933.

microphone. The ratio  $e/p$  is usually expressed in decibels with respect to some arbitrary reference level. The pressure upon the diaphragm may be generated by a pistonphone, thermophone or an electrostatic actuator.

(a) *Pistonphone*<sup>3,4</sup>. — A schematic arrangement of a pistonphone for use in calibrating a pressure type microphone having a diaphragm of high acoustic impedance is shown in Fig. 11.1*A*. The small piston is driven

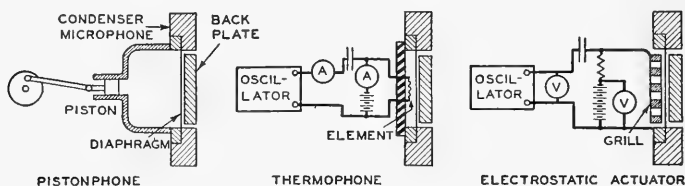

FIG. 11.1. Apparatus for obtaining the pressure frequency characteristic of a condenser type microphone. The pistonphone and thermophone may be used for other types of pressure microphones.

by a crank. The pressure generated at the diaphragm, assuming all of the walls of the enclosure to be rigid, is

$$p = \frac{rAp_0\gamma}{V} \left\{ 1 + \frac{(\gamma - 1)A_w}{\alpha V_0} + \frac{1}{2} \left( \frac{(\gamma - 1)A_w}{\alpha V_0} \right)^2 \right\}^{-1/2} \quad 11.1$$

where  $p$  = peak pressure, in dynes per square centimeter,  
 $V_0$  = volume of the enclosure, in cubic centimeters,  
 $A$  = area of the piston, in square centimeters,  
 $r$  = radius of the crank, in centimeters,  
 $p_0$  = atmospheric pressure, in dynes per square centimeter,  
 $\gamma$  = ratio of specific heats (1.4 for air),

$$\alpha = \sqrt{\frac{\omega\rho C_p}{2K}} = 3.9\sqrt{f} \text{ for air, } 20^\circ\text{C},$$

$A_w$  = area of metallic walls, in square centimeters,  
 $K$  = thermal conductivity of the enclosed gas ( $6.2 \times 10^{-5}$  for air)  
 $\rho$  = density of the gas, in grams per cubic centimeters,  
 $C_p$  = specific heat of the gas at constant pressure (.24 for air),  
 $\omega = 2\pi f$ , and  
 $f$  = frequency, in cycles per second.

<sup>3</sup> Olson and Massa, "Applied Acoustics," 2nd. Ed., p. 267, P. Blakiston's Son and Co., Philadelphia, 1939.

<sup>4</sup> A dynamically driven pistonphone has been described by Glover and Baumzweiger, *Jour. Acous. Soc. Amer.*, Vol. 10, No. 3, p. 200, 1939.

This method is very useful for calibrating a microphone at the low frequencies. The upper frequency limit is governed by the permissible speed of the mechanical system which is approximately 200 cycles.

Under test the output of the microphone is fed to an amplifier and output meter. For a particular value of generated pressure the output is noted. Then, the pistonphone is disconnected and a voltage of the same frequency as that generated by the pistonphone is inserted in series with the microphone and adjusted to give the same output. The response ( $e/p$ ) at this frequency is the ratio of this voltage to the applied pressure.

(b) *Thermophone*<sup>5,6,7</sup>. — The thermophone consists of one or more strips of thin gold leaf mounted upon terminal blocks, Fig. 11.1*B*. In the usual method the thermophone strip carries a known steady current upon which a smaller sinusoidal current is superimposed. In this case, the variation of the pressure in the chamber occurs primarily at the frequency of the alternating current. The cavity of the thermophone is usually filled with hydrogen. The wavelength in hydrogen is considerably longer than in air and, as a consequence, the standing waves are shifted to a higher frequency beyond the useful response range.

The peak alternating pressure developed in the cavity is given by

$$p = \frac{.96 S i_0 i r_E}{\omega m C V A \alpha D^{1/2}} \quad 11.2$$

$$\text{where } D = \left(1 - \frac{4KS^2}{\omega CVA}\right)^2 + \left(1 + \frac{4S}{VA\alpha} + \frac{4KS\alpha}{\omega C} + \frac{4KS^2}{\omega CVA}\right)^2$$

$$A = \frac{T_\alpha}{T_s} \frac{\gamma}{\gamma - 1} - 1$$

$$m = \frac{(\gamma - 1)T_s}{\gamma p_0}$$

$$\alpha = \sqrt{\frac{\omega C_{p\rho}}{2K}}$$

$C$  = total thermal capacity of the strip, product of the mass in grams and the specific heat,

$i_0$  = steady current, in amperes,

$i$  = peak value of the alternating component, in amperes,

<sup>5</sup> Arnold and Crandall, *Phys. Rev.*, Vol. 10, No. 1, p. 22, 1917.

<sup>6</sup> Wente, E. C., *Phys. Rev.*, Vol. 19, No. 4, p. 333, 1922.

<sup>7</sup> Ballantine, S., *Four. Acous. Soc. Amer.*, Vol. III, No. 3, p. 319, 1932.

- $r_E$  = total resistance of the strip, in ohms,  
 $T_S$  = mean temperature of the strip, absolute degrees,  
 $T_\alpha$  = mean temperature of the gas in the enclosure, absolute degrees,  
 $K$  = thermal conductivity of the gas,  
 $\rho$  = density of the gas, in grams per cubic centimeter,  
 $C_V$  = specific heat of the gas at constant volume,  
 $C_p$  = specific heat of the gas at a constant pressure,  
 $\gamma = C_p/C_V$ ,  
 $p_0$  = average pressure of the enclosure, in dynes per square centimeter,  
 $S$  = total area of one side of the thermophone foil, in square centimeters,  
 $V$  = volume of the enclosure, in cubic centimeters,  
 $\omega = 2\pi f$ , and  
 $f$  = frequency, in cycles per second.

The determination of the ratio  $e/p$  is carried out in the same manner as the pistonphone.

(c) *Electrostatic Actuator* <sup>8</sup>. — The electrostatic actuator consists of an auxiliary electrode in the form of a grill mounted in front of the microphone diaphragm, Fig. 11.1C. The actuator is perforated so that it does not appreciably alter the impedance opposing the motion of the diaphragm. A large steady polarizing voltage is applied to the grill and microphone diaphragm. Then a sinusoidal voltage is applied, effectively, in series. The alternating force in dynes per square centimeter of the grill, assuming no tufting of the electrostatic lines, from equation 6.35 is

$$p = \frac{8.85e_0e}{d^2} \times 10^{-7} \quad 11.3$$

where  $e_0$  = polarizing voltage, in volts,

$e$  = alternating voltage, in volts, and

$d$  = spacing between the actuator and the diaphragm, in centimeters.

The force developed by the actuator is independent of the frequency. Therefore, it constitutes a simple system for obtaining the response of a condenser microphone as a function of the frequency. If the absolute response is desired this may be obtained by comparison with some known standard. (Thermophone or pistonphone.) In the case of some actuator structures the effective area may be calculated from standard formulas which correct for tufting.

<sup>8</sup> Ballantine, S., *Jour. Acous. Soc. Amer.*, Vol. 3, No. 3, p. 319, 1932.

The determination of the ratio  $e/p$  is carried out in the same manner as the pistonphone.

2. *Field Response.* — The field or free wave response frequency characteristic of a microphone is the ratio  $e/p$  as a function of the frequency where  $e$  is the open circuit voltage generated by the microphone in volts and  $p$  is the sound pressure in dynes per square centimeter in a free progressive wave prior to the introduction of the microphone.

At the present time the Rayleigh<sup>9,10,11,12</sup> disk provides the only satisfactory method for obtaining the field response frequency characteristic of a microphone. Rayleigh observed that when a disk was suspended by a light fiber it would tend to turn at right angles to the impinging sound wave. Koenig<sup>13</sup> developed the formula for the turning moment of the disk as

$$M = \frac{4}{3} \rho a^3 u^2 \sin 2\theta \quad 11.4$$

where  $M$  = turning moment acting upon the disk, in dynes per centimeter,  
 $\rho$  = density of the fluid, in grams per cubic centimeter,  
 $a$  = radius of the disk, in centimeters,  
 $\theta$  = angle between the normal to the disk and the direction of propagation of the sound wave, in degrees, and  
 $u$  = particle velocity of the sound wave, root-mean square, in centimeters, per second.

When a sound wave falls upon the disk the angular deflection will be

$$\phi = \frac{M}{S} \quad 11.5$$

where  $S$  = moment of torsion of the suspension, in dynes per centimeter.

The moment of torsion of the suspension is given by

$$S = \frac{I}{T^2} [4\pi^2 + (\log_e \gamma)^2] \quad 11.6$$

where  $T$  = periodic time of the suspended disk, in seconds,

$I$  = moment of inertia of the disk,

$I = ma^2/4$ ,

<sup>9</sup> Rayleigh, *Phil. Mag.*, Vol. 14, p. 186, 1882.

<sup>10</sup> Ballantine, *Phys. Rev.*, Vol. 32, No. 6, p. 988, 1920.

<sup>11</sup> Olson and Goldman, *Electronics*, p. 106, Sept., 1931.

<sup>12</sup> Sivian, L. J., *Bell Syst. Tech. Jour.*, Vol. 10, No. 1, p. 96, 1931.

<sup>13</sup> Koenig, *Ann d., Physik*, Vol. 43, p. 43, 1891.

- $m$  = mass of the disk, in grams,  
 $a$  = radius of the disk, in centimeters, and  
 $\gamma$  = damping factor, the ratio of two successive swings.

From equations 11.4, 11.5 and 11.6 it is possible to determine the particle velocity  $u$  in the sound wave.

The arrangement of a Rayleigh disk for field calibrations of microphones is shown in Fig. 11.2. The source of sound is a small direct radiator loud speaker, with the back completely enclosed, placed halfway between the disk and the microphone. See Sec. 11.5. A small loud speaker is used so that a spherical wave will be emitted. If a velocity microphone is used no correction need be made for the spherical wave because the Rayleigh disk also measures the particle velocity. If a pressure microphone is used

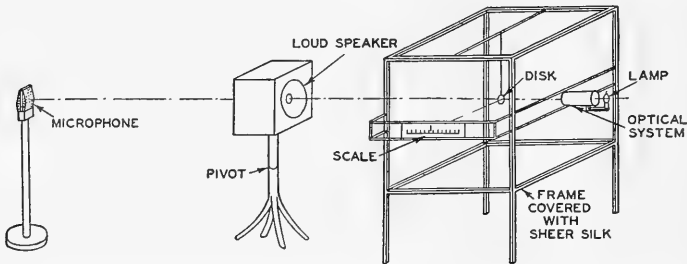

FIG. 11.2. Arrangement of apparatus for obtaining the field response of a microphone by means of a Rayleigh disk.

the appropriate correction for the accentuation in velocity in a spherical wave must be made. See Sec. 1.5D and Fig. 1.3. From the geometry of the system of Fig. 11.2 the deflection of the disk can be determined from the deflection of the light beam on the scale.

A high quality microphone calibrated by any of the above systems may be used as a secondary standard for the calibrations of other microphones.

**B. Directional Characteristic.** — The directional characteristic of a microphone is an expression of the variation of the behavior of the microphone with respect to direction. A polar diagram showing the output variation of the microphone with direction is usually employed.

The directional characteristics should be obtained at representative frequencies. In order to obviate any errors due to reflections the directional measurements should be made outdoors. Obviously, very slight reflections will introduce considerable error for the angles in which the response is very low.

A cathode ray tube with a long persistence screen may be used to obtain

the directional characteristic of a microphone or loud speaker. The apparatus of Fig. 11.3 is arranged to obtain the directional characteristic of the microphone. The directional characteristic of the loud speaker may be obtained by placing the loud speaker upon the rotating shaft and keeping the microphone fixed in position. The sound is picked up by a microphone and amplified. The output of the amplifier is detected and fed to a low pass filter. The output of the filter is amplified by a d-c amplifier, the output of which is fed to two potentiometers. The arms of the potentiometers are spaced at  $90^\circ$ . The potentiometer arms and microphone shaft are

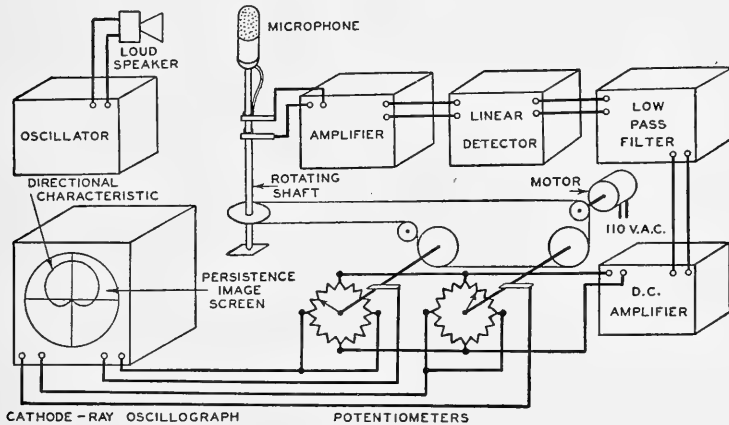

FIG. 11.3. Schematic arrangement of the apparatus employing a cathode ray tube with a long persistence screen as a polar directional characteristic indicator and recorder.

rotated by a motor. The length of the radius vector of the spot is proportional to the output of the microphone. The angular displacement of the spot is synchronized with the microphone shaft. From this it will be seen that the cathode ray beam traces the polar directional characteristic of the microphone. In case it is desirable to record the characteristic, this may be done photographically or by tracing the curve left upon the screen.

*C. Nonlinear Distortion Characteristic.*—The harmonic distortion tests are intended to show the spurious harmonics generated by the microphone when it is actuated by a pure tone. The plot of the total distortion in per cent of the fundamental is termed the distortion characteristic. It is also common to plot the individual components in per cent as the distortion characteristics.

It is difficult to obtain a sound source which will generate an intense

sound wave of very low distortion in free space. The arrangement<sup>12A</sup> shown in Fig. 11.4 provides a simple means of obtaining a sound wave free from distortion. A stationary wave is obtained in the tube by moving the piston until the maximum pressure is obtained. A pressure of 1000 dynes per square centimeter can be obtained with a fraction of a watt input to the loud speaker. For the determination of the second harmonic the microphone is placed at a second harmonic node. Under these conditions the second harmonic component at the microphone is very small. The second harmonic component is then measured by means of a harmonic analyzer. See Sec. 11.3C. For the third harmonic the microphone is

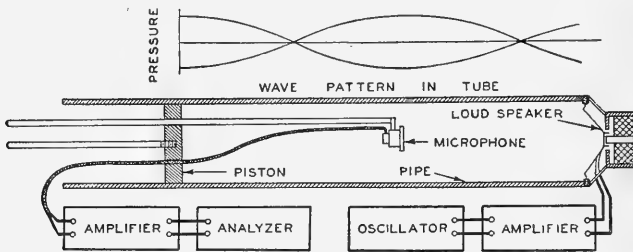

FIG. 11.4. Arrangement of apparatus for measuring the non-linear distortion generated by a microphone. (After Phelps.)

placed at a third harmonic node. Either pressure or velocity microphones may be tested, the only difference being in the position in the tube.

D. *Phase Distortion Characteristic.* — The phase distortion characteristic of a microphone is a plot of the phase angle between the voltage output of the microphone with respect to some reference voltage as a function of the frequency. A microphone such as the velocity microphone, see Sec. 9.3B, in which the output is in phase with the particle velocity (its output is also in phase with the pressure in a plane sound wave), may be used as the reference standard. The standard microphone and the microphone to be tested may be placed side by side in a plane progressive wave in free space, Fig. 11.5. The outputs of the two microphones are amplified by separate identical amplifiers and connected to the vertical and horizontal plates of a cathode ray oscillograph. The resultant Lissajou figure indicates the phase relations between the output of the two microphones. The two microphones are shifted relative to each other in a line parallel to the direction of propagation until the outputs of the two microphones

<sup>12A</sup> Phelps, W. D., *Four. Acous. Soc. Amer.*, Vol. 11, No. 2, p. 219.



are in phase. The phase angle, in degrees, between the output of the two microphones is

$$\phi = \frac{d}{\lambda} 360^\circ \quad 11.7$$

where  $d$  = distance between the two microphones in the direction of propagation, in centimeters, and  
 $\lambda$  = wavelength of the sound, in centimeters.

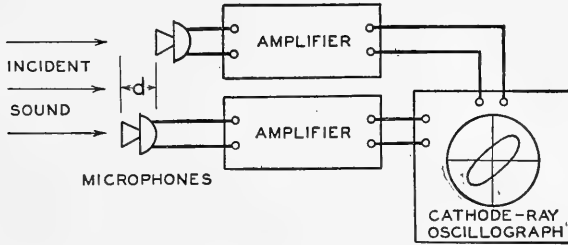

FIG. 11.5. Schematic arrangement of apparatus for measuring the phase characteristic of a microphone.

Phase distortion is of importance in combination microphones such as the unidirectional microphone. See Sec. 9.4.

E. *Electrical Impedance Characteristic.* — The electrical impedance characteristic of a microphone is the impedance at the output terminals as a function of the frequency. Any convenient method for measuring electrical impedance may be used for determining the impedance characteristic.

F. *Transient Response Characteristic.* — For measurement of transient response, see Sec. 11.3G.

**11.3. Testing of Loud Speakers.** — Many different measurements are required to determine the performance of a loud speaker. The most important characteristics which depict the performance of a loud speaker are as follows:

1. Response frequency characteristic.
2. Directional characteristic.
3. Nonlinear distortion characteristic.
4. Efficiency frequency characteristic.
5. Phase distortion characteristic.
6. Electrical impedance characteristic.
7. Transient response characteristic.

A. *Response Frequency Characteristic.*

1. *Response*<sup>14</sup>. — The response of a loud speaker is a measure of the sound produced at a designated position in the medium with the electrical input, frequency and acoustic conditions specified.

Absolute response is the ratio of the sound pressure (at a specified point in space) to the square root of the apparent electrical power input. It is given by the equation

$$\text{Absolute response} = \frac{p}{\frac{e}{\sqrt{z_E}}} = \frac{p \sqrt{z_E}}{e} \quad 11.8$$

where  $p$  = measured sound pressure, in dynes per square centimeter,  
 $e$  = effective voltage applied to the voice coil, in volts, and  
 $z_E$  = absolute value of the impedance of the voice coil, in ohms  
 ( $z_E$  is a function of frequency).

The absolute response characteristic is obtained by measuring the sound pressure  $p$  as a function of frequency with constant voltage  $e$  on the voice coil, and measuring impedance  $z_E$  as a function of the frequency, and correcting the measured sound pressure for the measured impedance in accordance with the equation. The resulting characteristic represents the sound pressure as a function of the frequency which would be obtained from the speaker if fed from the generator which would automatically deliver constant apparent power  $e^2/z_E$  to the voice coil over the frequency range.

The response may be expressed by a value equal to the above ratio or may be expressed in decibels relative to an arbitrary value of response corresponding to one volt, one ohm and one dyne per square centimeter.

$$\text{Absolute response} = 20 \log_{10} \frac{\frac{p}{e/\sqrt{z_E}}}{\frac{1}{1/\sqrt{1}}} = 20 \log_{10} \frac{p}{e/\sqrt{z_E}} \quad 11.9$$

The outdoor or free space response frequency characteristic is the simplest method for making loud speaker measurements which may be duplicated and compared among laboratories. Outdoor measurements have the disadvantage of being dependent upon the weather and noise conditions and, for this reason, nearly all development and routine work on

<sup>14</sup> Standards on Electroacoustics, Institute of Radio Engineers, 1938.

loud speakers is generally carried on in rooms. Each laboratory can correlate its own indoor with outdoor measurements. The testing of loud speakers under actual conditions is also useful, such as the operation of a radio receiver in a living room. As the art in sound measurement progresses, this type of measurement will become more important.

2. *Apparatus for Measuring the Sound Pressure Frequency Relationship of a Sound Source.*—An arrangement for obtaining the sound pressure characteristic by the semiautomatic method<sup>15</sup> is shown in Fig. 11.6.

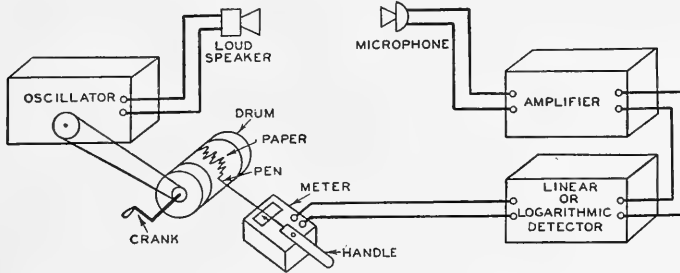

FIG. 11.6. Schematic arrangement of the apparatus for manually recording the sound pressure frequency characteristic of a sound source. (After Wolff and Ringel.)

This method yields a response frequency curve on semilogarithmic paper in about three minutes. Rotation of a condenser governing the beat frequency and coupled to a drum on which the paper record is made gives the abscissas for the curves, values which are proportional to the logarithm of the frequency due to the manner in which the condenser plates are cut. The drive may be manual or by motor.

A linear or logarithmic detector<sup>16,17</sup> may be employed. In the latter, the deflection of the meter is a logarithmic function of the sound pressure. The resulting curve is recorded directly in decibels. A variation of this method is sometimes used in which the recording pen is coupled to a gain control in the amplifier, the operator manipulating the control in such a manner that the output indicated by the meter remains constant. Either a linear or a logarithmic co-ordinate scale may be obtained by suitable design of the gain control.

The acoustic level recorder<sup>18</sup> is an automatic device which records the gain settings required to keep the amplifier output constant as the fre-

<sup>15</sup> Wolff and Ringel, *Proc. I. R. E.*, Vol. 15, No. 5, p. 363, 1927.

<sup>16</sup> Ballantine, S., *Jour. Acous. Soc. Amer.*, Vol. 5, No. 1, p. 10, 1933.

<sup>17</sup> Hackley, R. A., *Broadcast News*, No. 28, p. 20, July, 1938.

<sup>18</sup> Wentz, Bedell and Swartzel, *Jour. Acous. Soc. Amer.*, Vol. 6, No. 3, p. 121, 1935.

quency of the sound source is varied. Figure 11.7 shows how a pressure characteristic can be made with the sound level recorder. A dark colored tape coated with white wax is moved under a stylus by a motor which changes the value of the beat frequency generated at the same time. The loud speaker under test is connected to the output of the beat frequency generator and the variations in response are recorded on the paper directly on a decibel scale by a stylus which scratches through the wax coating on the recording paper.

The rectifier output incorporates a control circuit which causes direct

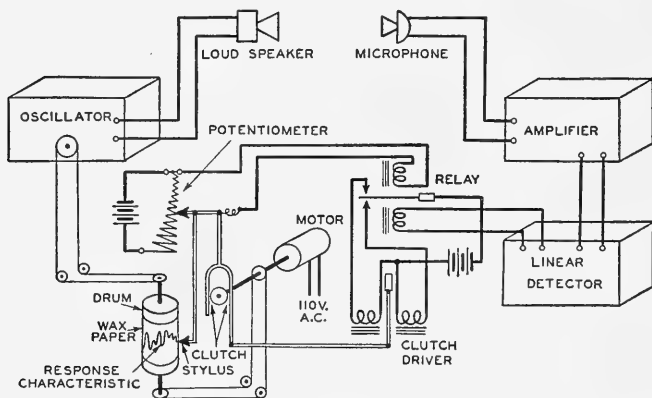

FIG. 11.7. Schematic arrangement of the apparatus used in a high speed level recorder for automatically recording a sound pressure frequency characteristic. (After Wentz, Bedell, and Swartzel.)

current to flow through one circuit when the rectifier current is less than a certain critical value and through a second circuit when it is greater than a second critical value. In the first case, the control circuit operates a magnetic clutch which causes a potentiometer to operate and increases the voltage. In the second case, the voltage is decreased.

The output of the rectifier is kept balanced to within the voltage change produced by a change in potentiometer corresponding to the smallest unit of the attenuator calibration. The motion of the potentiometer is communicated to the stylus which gives a trace on the recording paper. The same motor which drives the oscillator frequency control moves the potentiometer by means of the magnetic clutches.

The speed with which changes in sound level are recorded may be varied from 10 to 560 db per second through alteration of the speed of rotation of the clutches.

A cathode ray tube,<sup>19,20</sup> with a long persistence screen, may be used as a response indicator and recorder, Fig. 11.8. A motor drives the beat frequency oscillator and a potentiometer. The potentiometer varies the voltage on the horizontal deflection plate of the cathode ray tube and thereby drives the cathode ray beam across the tube in synchronism with the oscillator. A reversing switch changes the direction of the motor travel at the upper and lower limits of the audio frequency range. The output of the oscillator actuates the loud speaker. The sound is picked up by the microphone and amplified. The output of the amplifier is detected by a linear or logarithmic detector and fed to a low pass filter. The output

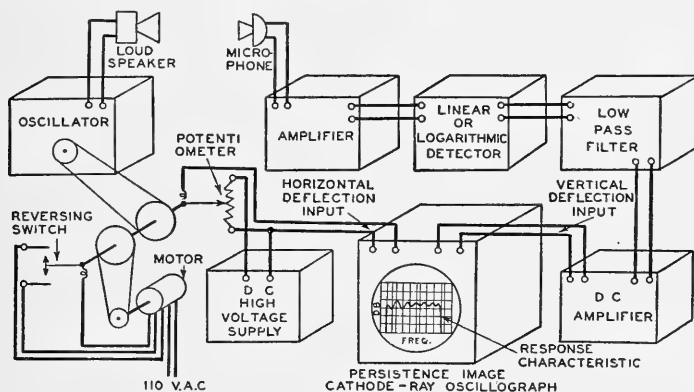

FIG. 11.8. Schematic arrangement of the apparatus employing a cathode ray tube with a long persistence screen as a pressure response frequency indicator and recorder. (After Hackley.)

of the filter is amplified by a d-c amplifier, the output of which is connected to the vertical plates of the cathode ray tube. The cathode ray beam traces the response characteristic upon the persistence image screen. The ordinates are in decibels when the logarithmic detector is used. The ordinates are proportional to the sound pressure when the linear detector is used. The time required to trace a response frequency characteristic of a loud speaker is about 30 seconds. The apparatus is very useful for development work because the motor sweeps through the range again and again. The operator is free to make changes in the equipment under test and note these changes upon the response. In case it is desirable to record the characteristic, this may be done photographically or by tracing the curve left upon the screen.

<sup>19</sup> Hackley, R. A., *Broadcast News*, No. 28, p. 20, July, 1938.

<sup>20</sup> Sherman, J. B., *Proc. I. R. E.*, Vol. 26, No. 16, p. 700, 1938.

A system for measuring the response of a loud speaker employing a thermal noise generator is shown in Fig. 11.9. A diode may be used as a source of thermal noise. The output is amplified, filtered and fed to a loud speaker. The frequency distribution of the energy fed to the loud speaker is shown in Fig. 11.9*A*. The output of the loud speaker is picked up by the microphone, amplified and passed through a narrow band pass filter. The response characteristic of the filter is shown in Fig. 11.9*B*.

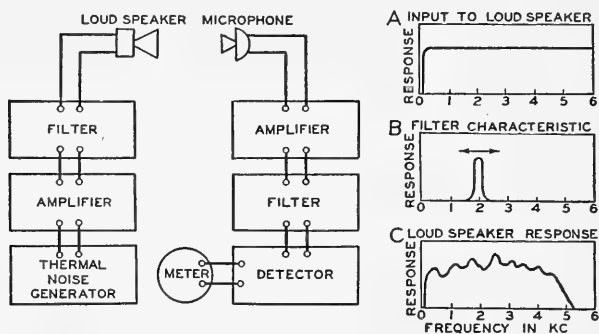

FIG. 11.9. Schematic arrangement of the apparatus employing a thermal noise generator and a band pass filter for obtaining the response frequency characteristic of a loud speaker *A*. Input to the loud speaker. *B*. The response frequency characteristic of the band pass filter. *C*. Response frequency characteristic of the loud speaker.

The band width of the filter should be independent of the frequency. The position of the filter pass band is varied with respect to frequency. The output of the filter is detected and measured by means of a meter. The response characteristic of a loud speaker is shown in Fig. 11.9*C*.

Apparatus employing thermal noise for obtaining response characteristics has not been developed to the stage where it may be used with the facility of other methods. It appears, however, that this type of measurement will become very important for all types of acoustic measurements when suitable apparatus has been developed.

3. *Calibration of the Sound Measuring Equipment*<sup>21</sup>. — The microphone should be calibrated in terms of a free progressive sound wave. The microphone, amplifier and detector should have a combined characteristic which is substantially independent of the frequency over the frequency range under consideration. If it is not substantially constant over the frequency range the data must be adjusted for known variations.

A general schematic circuit arrangement showing one specific way to

<sup>21</sup> Standards on Electroacoustics, Institute of Radio Engineers, 1938.

obtain the factor  $p/e$  in the formula for absolute response (equation 11.8) is shown in Fig. 11.10. This arrangement has the feature that it does not require an absolute calibration of the measuring system.

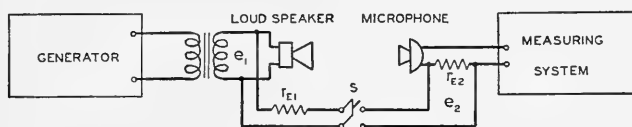

FIG. 11.10. Schematic arrangement for obtaining the factor  $p/e$  in the formula for absolute response.

Referring to Fig. 11.10, the absolute response is given by

$$\begin{aligned} \text{Absolute response, in decibels,} &= 20 \log_{10} \frac{p}{e} \sqrt{z_E} \\ &= [A - B - C - D] + 10 \log_{10} z_E \quad 11.10 \end{aligned}$$

where  $A$  = output of measuring system, in decibels, with the microphone picking up sound from the loud speaker with  $S$  open,

$B$  = output of measuring system, in decibels, with  $S$  closed and the microphone shielded from sound,

$C$  = open circuit voltage output of the microphone, in decibels above one volt for one dyne per square centimeter, in a free progressive wave,

$D = 20 \log e_1/e_2 = 20 \log (r_{E1} + r_{E2})/r_{E2}$ , and

$z_E$  = impedance of loud speaker, in ohms.

$r_{E2}$  should be sufficiently small compared to the impedance of the microphone or, in other words, the output of the microphone should not change when  $r_{E2}$  is short circuited.  $r_{E1}$  should be so selected as to obtain a value of  $B$  in the range of the values obtained for  $A$ .

4. *Outdoor or Free Space Response*<sup>22</sup>. — In all outdoor tests the loud speaker and microphone should be removed a sufficient distance from reflecting surfaces so that the only sound striking the microphone is direct sound (fifteen to twenty feet from the ground or other reflecting surfaces). Any microphone calibrated in terms of plane progressive wave pressure may be used.

For the purpose of these tests, loud speakers are divided into two classes. The first class includes direct radiator loud speaker units which are designed for operation in some additional structure such as a baffle or

<sup>22</sup> Olson and Massa, "Applied Acoustics," 2nd Ed., p. 325, P. Blakiston's Son and Co., Philadelphia.

cabinet. The second class are complete units and require no additional structures. Examples of this type are horn loud speakers or loud speakers already mounted in housings.

The loud speaker unit should be mounted one foot off center in a direction parallel to one side and six inches off center in a right angle direction in a twelve foot square baffle of sufficient thickness so that no radiation results from vibration of the baffle. The microphone should be located on the axis of the radiator at a distance of five feet from the surface of the baffle when the maximum transverse dimension of the radiator is not greater than two and one half feet. For larger radiators, the distance should be the smallest integral multiple by five feet, which is greater than twice the maximum transverse dimension of the radiator and should be specified with the test results. The response frequency characteristic of the loud speaker can then be obtained by one of the methods described in the section on apparatus and plotted in decibels, equation 11.10 (on an ordinate scale of 30 db or less per cycle of logarithmic scale of frequency). This gives the response frequency characteristic of the loud speaker on the axis.

Complete speakers should be tested in the same manner as speaker units alone, but without the use of additional baffles.

Routine tests and development work upon acoustical instruments are usually made indoors reserving the outdoor measurements for a standard. The room should be made as large as possible in order to obtain a maximum ratio of direct to reflected sound. Standing wave phenomena will be minimized if the dimensions of the room are made 3 : 4 : 5. Several layers<sup>23</sup> of absorbing material should be used with a separation of from one to six inches between layers. Reflections will be further minimized if strips of absorbing material twelve inches in width are placed normal to the walls and spaced twelve inches apart.

When only a small deadened room is available a "close up" curve may be the only one possible. Such a curve may be useful in determining system resonance and the general smoothness of the output.

The rotating microphone<sup>24</sup> has been found to be very useful for reducing reflection errors. The microphone is revolved in a circle about five feet in diameter. The plane of the circle is inclined at an angle of 30° towards the horizontal. The microphone is arranged so that it always is directed towards the source of sound. Any of the systems described in Sec. 11.3A2 may be used for recording the response frequency characteristic.

---

<sup>23</sup> Bedell, E. H., *Jour. Acous. Soc. Amer.*, Vol. 8, No. 2, p. 118, 1937.

<sup>24</sup> Bostwick, L. G., *Bell Syst. Tech. Jour.*, Vol. 8, No. 1, p. 135, 1929.



A modification of the above test procedure is to use a stationary microphone and warble the frequency (20 cycles + 10 per cent of the mean audio frequency as a maximum total band width) to average out reflection errors. This method tends to average out very short or abrupt variations in the loud speaker response. The check response frequency measurement taken close to the loud speaker with no warble should be made to determine if there are any abrupt variations in its response.

5. *Living Room Measurements*<sup>25</sup>. — The performance of a radio receiver in a living room has been discussed in Sec. 12.2J. The characteristics shown in Fig. 12.12 were obtained with the cathode ray response measuring system described in Sec. 11.3A2. However, any of the systems described in Sec. 11.3A2 may be used. It is customary to obtain a large number of characteristics for each position of the receiver in the room.

6. *Theatre Measurements*. — The performance of a loud speaker in a theatre has been discussed in Sec. 12.2B. The characteristics for the various parts of the theatre may be obtained with any equipment described in Sec. 11.3A2. However, the high speed response measuring equipments are preferable for this type of work.

7. *Automobile Measurements*. — The conditions under which an automobile radio receiver operates differ widely from those of a loud speaker in a room. For this reason it is very important to test the performance under actual operating conditions. The response frequency characteristic should be obtained by placing the microphone at the ear position in each of the normal listening positions in the automobile. In the case of back seat measurements persons should be seated in the front seat to simulate actual conditions. Measurements should be made with the windows open and closed. In general, the response frequency characteristics will differ widely for the front and back seats. It is customary to favor the front seats in determining the optimum response frequency characteristic. At high speeds wind, road rumble and engine noises are quite high and mask the reproduced sound. The power output should be sufficient to override these noises and give intelligible speech. In view of the fact that the sound level delivered by the loud speaker is quite high under these conditions, it is important that the response frequency characteristic be smooth, otherwise the reproduced sound will be disagreeable.

The response frequency characteristics may be obtained with any equipment described in Sec. 11.3A2.

B. *Directional Characteristic*. — The directional characteristic of a loud speaker is the response as a function of the angle with respect to some

<sup>25</sup> Wheeler and Whitman, *Proc. I. R. E.*, Vol. 23, No. 6, p. 610, 1935.

axis of the system. The characteristics may be plotted as a system of polar characteristics for various frequencies or as response frequency characteristics for various angles with respect to the reference axis.

The directional characteristics of a direct radiator loud speaker in a very large baffle may be obtained at a distance of five feet. For a small baffle or cabinet the distance should be at least three times the largest linear dimension of the system. The directional characteristics of a horn loud speaker should be obtained at a distance three or more times the largest dimension of the mouth.

Obviously, very slight reflections will introduce considerable error for angles in which the response is very low. For this reason, it is almost

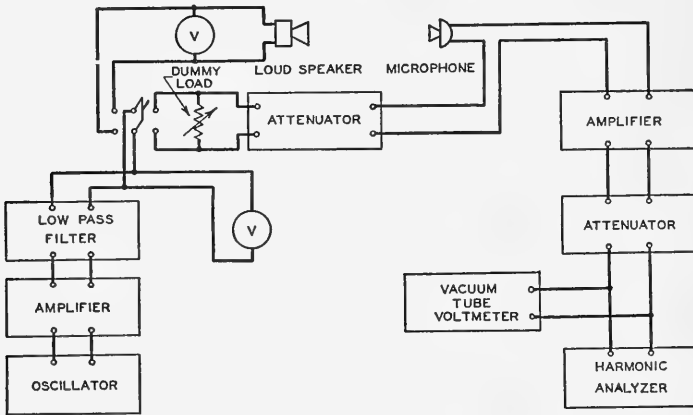

FIG. 11.11. Schematic arrangement of the apparatus for measuring the non-linear distortion of a loud speaker.

imperative that the measurements be made outdoors in free space. Apparatus for obtaining directional characteristics is described in Sec. 11.2B.

*C. Nonlinear Distortion Characteristic.*— The nonlinear distortion characteristic of a loud speaker is a plot of the total distortion in per cent versus the frequency at a specified input power. A plot of the individual components of the distortion in per cent versus frequency is also used to depict the distortion characteristic of a loud speaker.

The apparatus and circuit in schematic form for measuring the distortion produced by a loud speaker are shown in Fig. 11.11. Great care must be taken to avoid appreciable harmonics in the sound generating and sound measuring equipment. To reduce the already low harmonic content in the signal generator to a negligible amount a variable cutoff low

pass filter, admitting only the fundamental, should be employed. The microphone and amplifiers may be the same as those used for response measurements. The harmonic analyzer may be any of the various types employed in distortion measurements on amplifiers.

In making the test, the output of the power amplifier is connected to the loud speaker. The sound is picked up by the microphone and then amplified and the measurement of harmonics is carried out in the conventional manner. The output switch is now thrown to the dummy load, the resistance of which should be the same as the impedance of the loud speaker at the measurement frequency. The variable attenuator is adjusted until the output of the microphone amplifier is the same as that obtained with the sound. The harmonic content under these conditions should be negligible. The purpose of this operation is to insure that no distortion is introduced by the associated measuring equipment. In the

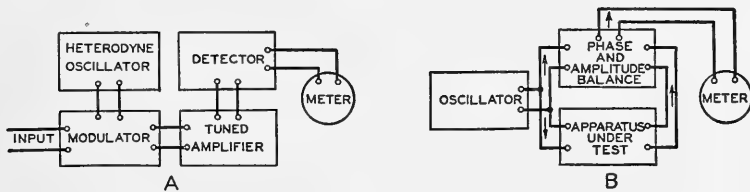

FIG. 11.12. Harmonic analyzers. *A.* Heterodyne analyzer. *B.* Balance bridge analyzer.

above discussion the possible distortion in the microphone has been neglected. The distortion generated by the microphone may be measured as outlined in Sec. 11.2C.

Harmonic distortion measurements should be made outdoors to eliminate errors due to standing waves. If it is necessary to make these measurements in a room, they should be made under a sufficient variety of conditions with respect to frequency and microphone placements to give average values which are not appreciably affected by the errors associated with room reflections.

Two systems which are in common use as harmonic analyzers are shown in Fig. 11.12.

The heterodyne analyzer<sup>26</sup> is shown schematically in Fig. 11.12*A*. The incoming signal, mixed with a carrier supplied by the heterodyne oscillator, is fed to the modulator. A balanced modulator is usually used so that the carrier will be suppressed. The heterodyne oscillator is adjusted so that the sum of its frequency and that of one of the components of the signal

<sup>26</sup> Arguimbau, L. B., *General Radio Experimenter*, Vol. 8, p. 1, June, July, 1933.

equals the pass band of the highly selective tuned amplifier. The high selectivity is usually obtained by means of a quartz filter. The upper side band is passed through the selective tuned amplifier, detected and then measured on a meter.

The balance bridge for measuring the total distortion is shown schematically in Fig. 11.12*B*. A part of the output of the oscillator is fed to the apparatus to be tested and another part to the analyzer. The amplitude and phase relations of the fundamentals from the oscillator and apparatus to be tested are adjusted by means of suitable networks so that none of

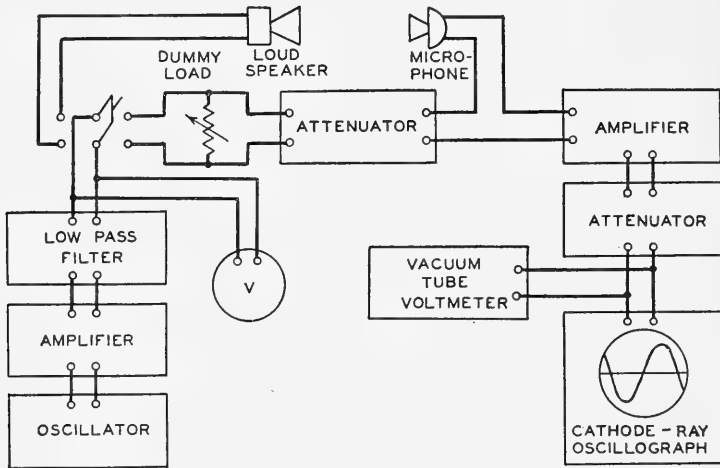

FIG. 11.13. Schematic arrangement of the apparatus employing a cathode ray tube for indicating the non-linear distortion of a loud speaker.

the fundamental remains. The remainder is the total harmonic generated by the system under test. This is measured by means of a root-mean-square meter.

The above procedure for obtaining the harmonic content requires considerable time and sometimes a qualitative indication requiring only a few minutes has been found to be very useful.

Figure 11.13 shows the circuits used in connection with a modern cathode ray oscillograph, having a stabilizing sweep circuit, to indicate qualitatively the extent to which harmonic distortion is introduced by a loud speaker. When the switch is thrown to the right and the sine wave generated in the oscillator is sent into the amplifying system through the attenuator, the cathode ray oscillograph should show a pure sine wave

form over the entire audio frequency range considered. The attenuator is adjusted to give the same amplitude of the wave pattern on the oscillograph screen as is secured when the switch is thrown to the left and the power is supplied to the loud speaker. With the switch in the latter position the microphone picks up the sound and the wave form is reproduced upon the fluorescent screen of the oscillograph. The departure from the pure sine wave is indicated readily by the difference in appearance of the pattern from the pure sine wave form secured with the switch thrown to the right. The extent of introduction of harmonics by the loud speaker can be estimated from a slight, moderate or very marked change in the wave form.

*D. Efficiency Frequency Characteristic*<sup>27</sup>. — The efficiency of a loud speaker at any frequency is the ratio of the total useful acoustical power radiated to the electrical power supplied to the load, the current wave of which exercises a controlling influence on the wave shape of the sound pressure. The plot of efficiency in per cent versus frequency is termed the efficiency characteristic.

The measurement of efficiency of a loud speaker may be divided into two methods, direct and indirect. One direct method depends on measuring the total energy flow through a spherical surface without reflections. Several indirect methods have been developed. The most common of these consists in measuring the electrical impedance under various conditions of diaphragm loading. It has been found in practice that these two methods of determining efficiency are those most widely used at the present time.

1. *Direct Determination of Radiated Power*<sup>27A</sup>. — The sound power output from a speaker at a particular frequency may be obtained by measuring the total flow of power through a spherical surface of which the sound source is the center. The surface of the sphere is divided into incremental areas and the power transmitted through each area is determined from the sound pressure and the particle velocity as well as the phase displacement between them. To simplify the process, the measurements may be made at a distance sufficiently large so that these quantities are in phase. Then, the radiated power may be determined by measuring the sound pressure or particle velocity over each incremental area (assuming the measuring equipment does not disturb the sound field and no standing wave pattern exists). The total power is equal to the summation of the

---

<sup>27</sup> Standards on Electroacoustics, Institute of Radio Engineers, 1938.

<sup>27A</sup> Olson and Massa, "Applied Acoustics," Blakiston's Son and Co., Philadelphia.

power transmitted through the incremental areas and may be expressed as

$$P_A = \frac{1}{\rho c} \iint p^2 dS \times 10^{-7} \quad 11.11$$

where  $P_A$  = total acoustic power, in watts,

$\rho$  = density of the medium, in grams per cubic centimeter.

$c$  = velocity of sound in medium, in centimeters per second,

$p$  = root-mean-square pressure, in dynes per square centimeter,  
over the element of areas  $dS$ , and

$dS$  = element of area on spherical surface, in square centimeters.

The input power can be determined in the obvious manner while operating under the above conditions.

The efficiency  $\mu$  in per cent is then

$$\mu = \frac{P_A}{P_E} \times 100 \quad 11.12$$

where  $P_A$  = total acoustic output, in watts, and

$P_E$  = electrical input, in watts.

As previously mentioned, the loud speaker should be located so that the reflected energy reaching the measuring equipment is negligible. This means that the measurements must either be made in a room with totally absorbing walls or in free space. The measurements and computations in this method are quite laborious. On the other hand, there can be no question as to the validity of the results which are obtained if the test is carefully conducted. Because of its fundamental nature and validity, the direct method is usually considered standard for determining loud speaker efficiency.

2. *Indirect Determination of Radiated Power.*—There are several methods for determining loud speaker efficiency by indirect means. The most common method is to measure the electrical impedance under various conditions of diaphragm loading.

A one-to-one ratio bridge, capable of measuring the impedance at the full power output of the speaker, should be used. Care should be taken that the temperature of the voice coil does not vary appreciably during the various measurements. The power supply for driving the speaker and bridge should be reasonably free from harmonic distortion.

The motional impedance method<sup>28</sup> is generally applied to moving coil electrodynamic speakers in which the force factor is real. In case the force

<sup>28</sup> Kennelly and Pierce, *Proc. A. A. A. S.*, Vol. 48, No. 6, 1912.

factor is imaginary it becomes rather complicated to employ the motional impedance method.

The efficiency  $\mu$ , in per cent, by the motional impedance method is given by

$$\mu = \frac{r_{EM}}{r_{EN}} \times 100 \quad 11.13$$

where  $r_{EM} = r_{EN} - r_{ED}$  motional resistance, in ohms,

$r_{EN}$  = resistive component with the system in the normal state, in ohms, and

$r_{ED}$  = damped resistance with the vibrating system blocked, in ohms.

This equation describes the simplest method of determining the efficiency from motional impedance measurements when the electromechanical coupling factor is real. See Chapters VI, VII and VIII. It assumes that the entire value of the motional resistance may be attributed to radiation resistance. This method adds the radiation from both sides of the diaphragm and, therefore, assumes that the radiation from both sides is useful. It assumes that there are no mechanical losses in the diaphragm and suspension system. These losses can be determined from the measurements of the motional impedance in a vacuum. Of course, in this case, the load on the diaphragm is not normal and the losses may be quite different from those which obtain under actual operating conditions. This method also assumes that there are no losses due to viscous air friction. Since the amplitude of the vibration of a voice coil is normally small at the higher frequencies, the problem of blocking the voice coil against motion is not a simple matter. Obviously, any motion will introduce an error in the determination of the efficiency.

*E. Phase Distortion Characteristic.* — The phase distortion characteristic of a loud speaker is a plot of the phase angle between the sound output and some reference sound as a function of the frequency.

Two microphones and separate amplifiers and a cathode oscillograph may be used as outlined in Sec. 11.2D, Fig. 11.5. A reference sound may be set up by a separate loud speaker, in which the phase shift is small, and picked up by one microphone. A reference voltage source may be substituted for the reference microphone. The sound from the loud speaker to be tested may be picked up on the other microphone. The phase difference may be determined as outlined in Sec. 11.2D. The phase distortion is of importance in the overlap region of the multiple channel sys-

tems. In this case the phase shift may be several hundred degrees (equivalent to a sound path difference of several feet). See Sec. 8.4*B*.

*F. Impedance Frequency Characteristic.* — The impedance characteristic of a loud speaker is the impedance at the input terminals as a function of the frequency. The plot of the characteristic should also include the resistive and reactive components.

A one-to-one ratio impedance bridge may be used and should be capable of measuring the impedance at the full power output of the speaker. The power input should be included with every impedance characteristic. If the impedance characteristic varies with power input, it is desirable to show a series of impedance frequency curves for various inputs. Other

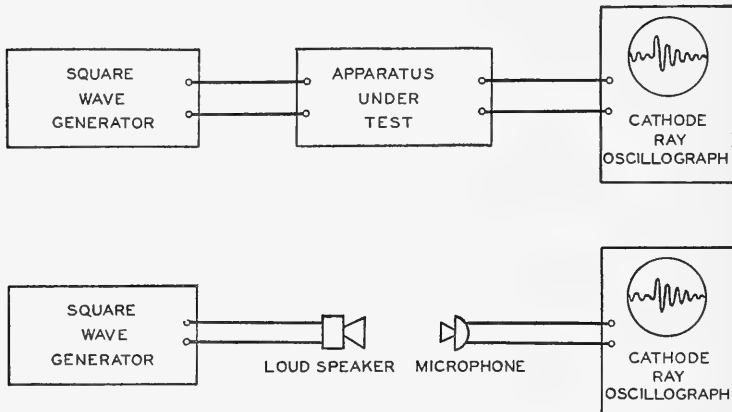

FIG. 11.14. — Schematic arrangement of the apparatus employing a square wave generator and a cathode ray tube for indicating the transient response characteristics of acoustical apparatus such as microphones or loud speakers.

methods may be used as, for example, the three voltmeter and a known resistance method.

*G. Transient Response Characteristic.* — The measurements in the preceding sections have been concerned with steady state conditions. In all types of sound reproduction the phenomena is of a transient character. For this reason it is important to measure the response of the system to a suddenly applied force or voltage. The Heaviside Operational Calculus is a very powerful tool for predicting the performance of a system to a suddenly applied force or voltage. See Sec. 7.16.

The apparatus for investigating the transient response of an audio system is shown schematically in Fig. 11.14. The output of a square wave generator is fed to the apparatus to be tested. The output of the



apparatus under test is fed to a cathode ray oscillograph. The deviation from the square wave is shown on the screen of the cathode ray oscillograph. Square waves offer a simple and rapid method of including both phase shift and amplitude response in a single test.

H. *Subjective Measurements.* — In many cases the apparatus for making all the objective tests outlined in the preceding sections is not always available. Furthermore, there is always some difficulty in evaluating the objective measurements. For this reason a subjective test of efficiency, frequency response, directional characteristics, nonlinear distortion and transient response in which two or more loud speakers are compared with a reference loud speaker system, is widely used. Or, in other words, this test determines the lumped effects of the following factors: loudness, frequency range, tone balance, spacial distribution, quality and hangover. The electrical input is usually broadcasting program material such as speech or music. The inputs should be adjusted until the reference and test loud speakers are judged to have equal loudness. The required attenuation of the electrical input determines the relative loudness efficiency of the loud speaker under test. The loud speakers should occupy positions which are symmetrical with respect to the room boundaries and the observer. The loud speakers should be sufficiently separated that interaction is negligible. A number of observers and a variety of program material should be used in order to insure statistical significance.

**11.4. Testing of Telephone Receivers.** — The characteristic of a telephone receiver should show the performance as normally worn on the ear. The sound intensity produced in the ear by the telephone receiver should be the same as the intensity produced in the ear when the head is immersed in the original sound field. There are two types of measurements upon telephone receivers, namely: subjective and objective.

A. *Subjective Measurements*<sup>29, 30, 30A</sup> — A free progressive sound wave is established by means of a loud speaker driven by an oscillator. The sound pressure at a distance of five feet from the loud speaker is measured by using a calibrated microphone, amplifier and output meter. With the receivers removed, the observer listens to the sound at the point where the sound pressure was measured by the microphone. Next, the observer places the receivers upon his head and the output of the oscillator is transferred from the loud speaker to the receivers by means of a suitable atten-

<sup>29</sup> Olson and Massa, *Four. Acous. Soc. Amer.*, Vol. 6, No. 4, p. 250, 1935.

<sup>30</sup> Olson, H. F., *Four. S. M. P. E.*, Vol. 27, No. 5, p. 537, 1936.

<sup>30A</sup> Olson and Massa, "Applied Acoustics," P. Blakiston's Son and Co., Philadelphia.

uator. The voltage across the receivers is adjusted until the intensity in the observer's ear seems to be the same as the free wave intensity from the loud speaker. This procedure is repeated at several frequencies, keeping the free wave pressure constant. The reciprocal of the voltage across the phones required to match the free wave sound intensity is proportional to the sensitivity of the receivers at each frequency.

B. *Objective Measurements*<sup>31, 32, 33, 33A</sup>. — The impedance frequency characteristic looking through the ear cap of a telephone receiver as normally worn has been investigated by Inglis, Gray and Jenkins. These are shown in Fig. 11.15. An artificial ear and the equivalent circuit which yields approximately the same impedance characteristic is shown in Fig. 11.15. A standard condenser microphone is used to measure the

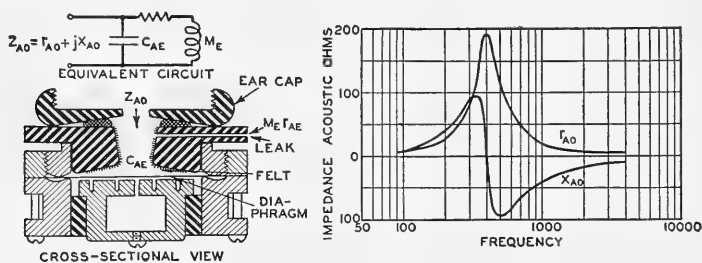

FIG. 11.15. A cross-sectional view of an artificial ear employing a standard condenser microphone and the equivalent electrical circuit of the acoustical system. The graph shows the resistive  $r_{A0}$  and reactive  $X_{A0}$  components of the acoustic impedance, looking into the aperture of the ear cap, as a function of the frequency.  $C_{AE}$  acoustic capacitance of the cavity.  $M_E$  and  $r_{AE}$  inductance and acoustic resistance of the leak.

pressure. A series of slits corresponding to the leak between the ear cap and the ear are represented by the inductance  $M_E$  and acoustic resistance  $r_{AE}$ . The walls of the cavity  $C_{AE}$  (4 cubic centimeters) are lined with felt to reduce resonances at the high frequencies. The response frequency characteristic obtained upon the artificial ear in general, agrees quite well with the subjective tests.

The tests outlined for loud speakers may be performed upon telephone receivers by employing the artificial ear. The same apparatus may of course be used and will not be repeated here.

The pressure delivered by a telephone to a closed cavity as a function of

<sup>31</sup> Inglis, Gray and Jenkins, *Bell Syst. Tech. Jour.*, Vol. 11, No. 2, p. 293, 1932.

<sup>32</sup> Olson and Massa, *Jour. Acous. Soc. Amer.*, Vol. 6, No. 2, p. 250, 1935.

<sup>33</sup> Olson, H. F., *Jour. S. M. P. E.*, Vol. 27, No. 5, p. 537, 1936.

<sup>33A</sup> Olson and Massa, "Applied Acoustics," P. Blakiston's Son and Co., Philadelphia.

the frequency is sometimes used to depict the response of a telephone receiver. The artificial ear shown in Fig. 11.15 may be used for this purpose by closing the slits.

The artificial mastoid is a system for objectively measuring the response of a bone conduction telephone receiver. In one form, the artificial mastoid<sup>33B</sup> consists of a rubber block having approximately the same impedance as the human head at the mastoid bone. The velocity which the bone conduction receiver delivers to this impedance is measured by a vertical or hill and dale phonograph pickup. See Sec. 10.3B3.

**11.5. Artificial Voice**<sup>34, 35</sup>. — The artificial voice is a term applied to a loud speaker which exhibits some of the characteristics of the human voice. One form of the artificial voice consists of a small dynamic loud speaker enclosed in a spherical case of the volume of the average human head. Using a cone one and one half inches in diameter and back enclosed, it is possible to obtain very uniform response over the range from 60 to 15,000 cycles. See Sec. 7.2. Due to the small diameter of the cone, the compliance of the case is negligible and the controlling compliance is the cone suspension. See Sec. 7.10. The directional characteristics of this loud speaker are very close to those of the human mechanism. The artificial voice is useful for obtaining the response frequency characteristic of close talking microphones because the reaction of the loud speaker upon the microphone is practically the same as that of the human voice. It is also useful for general development work on microphones because, with the small cone, the irregularities in response can be made less than  $\pm 1$  db. The power output at a distance of one to two feet is sufficient for most development work on microphones.

**11.6. Measurement of Acoustic Impedance.** — There are a number of methods of measuring acoustic impedance. A purely acoustical means for measuring acoustic impedance has been devised by Stewart. This method measures the change in acoustic transmission through a long uniform tube when the unknown impedance is inserted as a branch.

The acoustic impedance bridge<sup>36, 37</sup> is shown schematically in Fig. 11.16.

---

<sup>33B</sup> Hawley, M. S., Bell Laboratories Record, Vol. 18, No. 3, p. 73, 1939.

<sup>34</sup> Inglis, Gray and Jenkins, *Bell Syst. Tech. Jour.*, Vol. 11, No. 2, p. 293, 1932.

<sup>35</sup> Olson and Massa, "Applied Acoustics," 2nd Ed., P. Blakiston's Son and Co., Philadelphia, 1939.

<sup>36</sup> Stewart, G. W., *Phys. Rev.*, Vol. 28, No. 5, p. 1038, 1926.

<sup>37</sup> For other systems for measuring acoustic impedance see Olson and Massa, "Applied Acoustics," 2nd Ed., P. Blakiston's Son & Co., Philadelphia, 1939; Flanders, P. B., *Bell Syst. Tech. Jour.*, Vol. 11, No. 3, p. 402, 1932; Morse, P. M., "Vibration and Sound," p. 209, McGraw Hill Book Co., New York, 1936.

The loud speakers are connected to two pipes, one of which is variable in length and the other equipped with a means for attaching the unknown impedance. At some distance beyond this point the two pipes are joined by a small pipe which, in turn, is connected to another pipe leading to a microphone and amplifier. Standing waves in the pipes are reduced by the introduction of small tufts of felt.

With the branch closed the voltage across the two loud speaker units

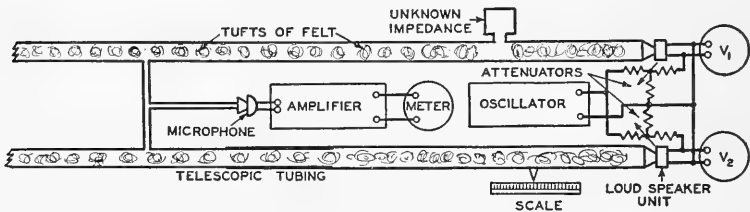

FIG. 11.16. Schematic arrangement of an acoustic impedance bridge for measuring impedance. (After Stewart.)

and the length of the variable tube are adjusted until a minimum reading is obtained in the output meter. The unknown impedance is now attached and the process repeated.

The unknown impedance can be obtained from the following equation

$$\frac{2z_{AU}}{2z_{AU} + r_A} = \frac{p_0}{p_0'} (\cos \theta + j \sin \theta) \quad 11.14$$

where  $z_{AU}$  = unknown impedance, in acoustic ohms,

$r_A = \rho c/A$  acoustic resistance of the damped pipe, in acoustic ohms,

$A$  = area of the pipe to which the branch is attached, in square centimeters,

$\rho$  = density of air, in grams per cubic centimeter, and

$c$  = velocity of sound, in centimeters per second.

The ratio  $p_0/p_0'$  can be determined from the following equation

$$\frac{p_0}{p_0'} = \frac{e_1 e_2'}{e_2 e_1'} \quad 11.15$$

where  $e_1$  and  $e_2$  = the voltages applied to the loud speaker without the branch, and

$e_1'$  and  $e_2'$  = the voltages with the branch attached.

The phase angle  $\theta$  in radians is given by

$$\theta = \frac{2\pi d}{\lambda} \quad 11.16$$

where  $d$  = distance between the first position of the pointer without the branch to the second position with the branch in place, in centimeters. The direction towards the loud speaker units is positive and

$\lambda$  = wavelength of sound in air, in centimeters.

**11.7. Measurement of Noise.** — Due to the complexity of the human hearing mechanism and to the various types of sounds and noises it is impossible, at the present time, to build a noise meter which will show the true loudness level. The discrepancies can be determined by actual use and suitable weighting factors applied to the results. Objective measurements are almost indispensable in any scientific investigation. The noise meter or sound level meter provides a system for measuring the sound level of a sound.

A schematic diagram of a sound level or noise meter is shown in Fig. 11.17. The microphone should be calibrated in terms of a free wave.

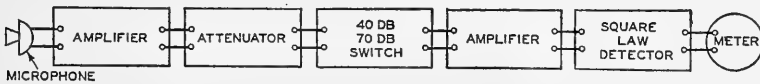

FIG. 11.17. Schematic arrangement of the components of a noise meter.

The directional characteristics of the microphone should be independent of the frequency. The attenuator and meter should be calibrated in decibels. A sound meter reading 60 db means a sound level of 60 db above the reference level. The reference point of the decibel scale incorporated in a sound meter shall be the reference sound intensity at 1000 cycles in a free progressive wave, namely:  $10^{-16}$  watts per square centimeter. The response frequency characteristic of the human ear shows less sensitivity for frequencies above and below 3000 cycles, Fig. 13.1. The overall frequency<sup>38</sup> response of an ideal noise meter should be the reciprocal of the ear response frequency characteristics. This would make the noise meter unduly complicated. The response frequency characteristics recommended for the noise meters by the American Standards Association are

<sup>38</sup> Amer. Tent. Standards for Sound Level Meters Z 24.3. American Standards Association, New York City, 1936, or *Jour. Acous. Soc. Amer.*, Vol. 8, No. 2, 1936.

shown in Fig. 11.18. Curve *A* is recommended for measurements at the lower levels and curve *B* for measurements around 70 db above the threshold. For very loud sounds (80 to 100 db), a flat characteristic should be used.

The noise meter may be used for noise analysis in offices, factories, restaurants, etc. In these measurements a large number of observations should be made in various positions. The noise meter may also be used to measure the transmission or attenuation by walls, floor, ceilings and doors. See Secs. 11.10 and 12.2*M*.

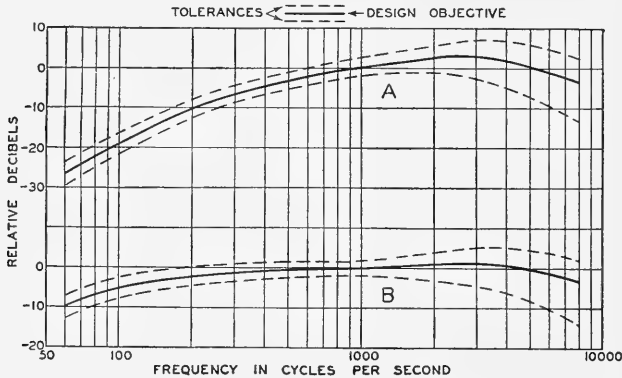

FIG. 11.18. Recommended characteristics for sound level meters. (American Standard Association.)

The noise meter is also a useful tool in work on the quieting of machinery. Since the radiation pattern of machinery noise is very complex a large number of measurements should be made in various directions relative to some axis of the system. For these investigations a frequency analyzer of the heterodyne type, See Sec. 11.3*C*, is a useful adjunct for determining the nature of the noise. For routine tests in manufacturing it is customary to establish passable limits together with fixed geometrical configurations and procedures. For routine tests it is absolutely necessary that the calibration remain correct within a decibel, i.e.,  $\pm\frac{1}{2}$  decibel.

**11.8. Measurement of Reverberation Time.** — The reverberation time for a given frequency is the time required for the average sound energy density, initially in a steady state, to decrease after the source is stopped to one millionth of its initial value. The unit is the second.

Many systems<sup>39</sup> have been developed for the measurement of rever-

<sup>39</sup> Olson and Massa, "Applied Acoustics," 2nd Ed., P. Blakiston's Son and Co., Philadelphia, 1939.

beration time. Sabine used an organ pipe as a source of sound, the ear as a detector and a stop watch for measuring the time. Since that time various types of chronographs, reverberation bridges, commutators, relays, etc., have been developed to measure the reverberation time of an enclosure.

The high speed level recorder, Fig. 11.7, and the high speed level indicator, Fig. 11.8, have been found to be the most useful means for measuring reverberation time because the trace of the entire decay of the sounds may be examined. From the rate at which the abscissa advances and the magnitude of the ordinate the rate of decay may be computed.

**11.9. Measurement of Absorption Coefficient** <sup>40, 41, 42, 43, 44</sup>. — The acoustic absorption coefficient of a surface is the ratio of the rate of sound energy absorbed by the surface to the incident rate of flow. All directions of incidence are assumed to be equally probable. The sabin is a unit of equivalent absorption and is equal to the equivalent absorption of one square foot of a surface of unit absorptivity, that is, one square foot of surface which absorbs all incident sound energy.

The total absorption in a room may be obtained from equations 12.2 or 12.3, if the reverberation time and the dimensions of the room are known. This method of obtaining the absorption coefficient of materials has been considered to yield the most reliable results.

Specialists in the measurement of absorption coefficients have used large chambers (volume of 4000 to 20,000 cubic feet) for determining the absorption coefficient of materials from the reverberation time. The reverberation time of these chambers, when empty, is from five to ten seconds. In chambers of this kind the absorption coefficients of very small samples may be determined. The absorption coefficients of representative materials obtained under the above conditions by various investigators are shown in Table 12.1, Sec. 12.2*A*.

In this connection it is interesting to note that there is considerable discrepancy between the values of absorption coefficients obtained in reverberant chambers and those obtained in actual use in rooms, studios and theatres. For this reason the values given in Table 12.1, Sec. 12.2*A*, must

<sup>40</sup> Watson, F. R., "Acoustics of Buildings," John Wiley and Sons, New York, 1923.

<sup>41</sup> Bagenal and Wood, "Planning for Good Acoustics," Methuen, 1931.

<sup>42</sup> Knudsen, V. O., "Architectural Acoustics," John Wiley and Sons, New York, 1932.

<sup>43</sup> Sabine, P. E., "Acoustics and Architecture," McGraw Hill Book Co., New York, 1932.

<sup>44</sup> Olson and Massa, "Applied Acoustics," 2nd Ed., P. Blakiston's Son and Co., Philadelphia, 1939.

be modified by a factor in computing the reverberation time of a room. It may be said, however, that this data indicates the relative efficiency of the various materials.

**11.10. Measurement of Transmission Coefficient.** — The transmission coefficient of a partition or wall is defined as the ratio of the transmitted sound energy to the rate of the incident flow of sound energy. The sound insulating properties of a partition consist of a determination of its transmission coefficient. In a general way, the noise reduction caused by a particular structure may be obtained by measuring the difference in level of a sound source with and without the intervening partition. For definition and equations relating to transmission loss and reduction factor See Sec. 12.2*M*. The sound source should be fed with a warbled frequency or rotated in a circle to average out reflection errors. The noise meter, Sec. 11.7, or, as a matter of fact, any of the sound measuring system, Sec. 11.3*A2*, may be used to measure the sound reduction. In some cases it may be desirable to use two or more samples of different shapes and areas. Whenever possible the measurements should be made under operating conditions. For the transmission characteristics of various structures see Table 12.3, Sec. 12.2*M*.

**11.11. Audiometry**<sup>45,46</sup>. — The acuity of hearing is measured by an audiometer. The audiometer consists of an audio oscillator for generating pure tones, an attenuator calibrated in decibels and a telephone receiver, Fig. 11.19. The usual range of test tones are 128, 256, 512,

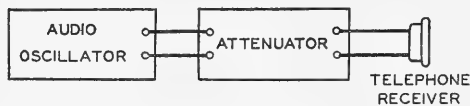

FIG. 11.19. Schematic arrangement of the components of an audiometer.

1024, 2048, 4096, 8192 cycles per second. The tone generated in the ear phone should be reasonably free from harmonics. The telephone receiver is calibrated as outlined in Sec. 11.4. The reference level is the normal threshold of audibility, Fig. 13.1. This level is the zero level of the audiometer. The person to be tested wears the earphone in the normal manner and the level at which the sound is no longer audible is noted on the attenuator. A person with normal hearing will show no hearing loss, while the person who is hard of hearing will show a hearing loss. These results

<sup>45</sup> Fletcher, H., "Speech and Hearing," D. Van Nostrand Co., New York.

<sup>46</sup> Proposed Specifications for Audiometers for General Diagnostic Purposes, *Jour. Acous. Soc. Amer.*, Vol. 9, No. 1, p. 72, 1937.



are plotted on a graph with the hearing loss in decibels as the ordinates and the frequency as the abscissa.

**11.12. Articulation Measurements**<sup>47, 48</sup>. — In the case of speech transmission the primary object is the realization of conditions which will result in the maximum intelligibility. Intelligibility is used to signify the accuracy and ease with which the articulated sounds of speech are recognized.

Many methods and tests are used to determine the person's ability to recognize the sounds of speech. Fundamentally, these methods consist of pronouncing speech sounds into one end of a transmission system and having the observer write the sounds which are heard at the receiving end. The comparison of the called sounds with those observed shows the number and kind of errors which are made. The system may be the air between the mouth and the ear in a room or it may be a telephone system, or a sound reproducing system such as a phonograph, radio or sound motion picture.

Speech material of various kinds may be used. The percentage of the total number of speech sounds which are correctly observed is called the sound articulation. The terms vowel articulation and consonant articulation refer to the percentages of the total number of spoken vowels or consonants which are correctly observed. If a syllable is used as a unit, the per cent correctly received is termed syllable articulation.

The discrete sentence intelligibility is the percentage of the total number of spoken sentences which are correctly understood. The discrete word intelligibility is the percentage of the total number of spoken words which are correctly understood. Lists have been prepared for use in articulation testing. These may be used to determine the performance of a system as outlined above.

---

<sup>47</sup> Fletcher, H., "Speech and Hearing," D. Van Nostrand Co., New York, 1929.

<sup>48</sup> Fletcher and Steinberg, *Jour. Acous. Soc. Amer.*, Vol. 1, No. 2, Part 2, p. 1, 1930.

## CHAPTER XII

### ARCHITECTURAL ACOUSTICS AND THE COLLECTION AND DISPERSION OF SOUND

**12.1. Introduction.** — The advent of sound reproducing systems has changed the problems involving architectural acoustics. Before the introduction of sound reproducing systems the major concern was the optimum reverberation time and the proper geometrical configuration for the best artistic effects in music and the maximum intelligibility of speech. By means of sound reproducing systems speech can be rendered intelligible where before it was either too weak to be heard above the general noise level or too reverberant. Furthermore, these instruments have opened a field for all manner of artistic effects never before possible.

The theatres which suffer most from insufficient loudness are, of course, the large enclosed theatre and the open air theatre. Sound reproducing systems have opened new vistas in musical renditions both by reproduction and re-enforcement. In certain instances the volume range of an orchestra is inadequate for full artistic appeal or to utilize the full capabilities of the hearing range. In these cases, means are required for augmenting the intensity of the original sound. The systems for accomplishing this objective are termed sound re-enforcing systems.

The acoustic problems involving the reproduction of sound motion pictures are quite unlike those of stage presentations. Reproduced sound offers greater possibilities for obtaining the proper artistic effects by the use of the following expedients: the use of incidental sound, a wide volume range, the control of the reverberation or room characteristics and the use of various sound effects.

For large outdoor gatherings, such as state occasions, athletic events in large stadiums and parks, sound reproducing systems are employed to amplify the speaker's voice.

In department stores, hotels, hospitals, schools and factories sound reproducing systems are employed to transmit sound from a central point to several independent rooms or stations. The systems for accomplishing this objective have been termed general announce or call systems.

**12.2. Dispersion of Sound**<sup>1,2,3,4,5,6</sup>. — A. *Sound Absorption and Reverberation*. — When a source of sound is started in a room the energy does not build up instantly due to the finite velocity of a sound wave. Each pencil of sound sent out by the source is reflected many times from the absorbing walls of the room before it is ultimately dissipated. A steady state condition obtains when the energy absorbed by the walls equals the energy delivered by the sound source. In the same way, when the source is stopped, some time is required before the energy in the room is completely absorbed. The reverberation time has been arbitrarily defined by Sabine as the time required for the sound to decrease to one millionth of its original intensity after stopping the source.

The equation<sup>7</sup> for the decay of the sound in a room is

$$E = E_0 e^{-cAt/4V} \quad 12.1$$

where  $E$  = sound energy density, after a time  $t$  seconds, after stopping the source, in ergs per cubic foot,

$A$  = total number of absorption units, in sabins (see definition below),

$E_0 = 4P_0/cA$ ,

$P_0$  = rate at which sound is generated by the source, in ergs per second,

$c$  = velocity of sound, in feet per second, and

$V$  = volume of the room, in cubic feet.

The acoustic absorptivity (or absorption coefficient) of a surface is the ratio of the flow of sound energy into the surface on the side of incidence to the incident rate of flow. The sabin is a unit of equivalent absorption and is equal to the equivalent absorption of one square foot of a surface of unit absorptivity, that is, of one square foot of surface which absorbs all incident sound energy.

From equation 12.1 the time required for the sound to decay to one

<sup>1</sup> Sabine, W. C., "Collected Papers in Acoustics," Harvard Uni. Press, Cambridge, Mass.

<sup>2</sup> Watson, F. R., "Acoustics of Buildings," John Wiley and Sons, New York, 1923.

<sup>3</sup> Begenal and Wood, "Planning for Good Acoustics," Methuen, 1931.

<sup>4</sup> Knudsen, V. O., "Architectural Acoustics," John Wiley and Sons, New York, 1932.

<sup>5</sup> Sabine, P. E., "Acoustics and Architecture," McGraw Hill Book Co., New York, 1932.

<sup>6</sup> Olson and Massa, "Applied Acoustics," 2nd Ed., P. Blakiston's Son and Co., Philadelphia, 1939.

<sup>7</sup> Franklin, W. S., *Phys. Rev.*, Vol. 16, p. 372, 1903.

millionth of its original intensity is

$$T = .050 \frac{V}{A} \quad 12.2$$

where  $T$  = time, in seconds,  
 $V$  = volume, in cubic feet, and  
 $A$  = total absorption, in sabins.

Later work <sup>8</sup> has shown that equation 12.2 is unsatisfactory for large rooms or rooms with very large absorption. The equation developed by Eyring is

$$T = \frac{.05V}{-S \log_{\epsilon}(1 - a_{av})} \quad 12.3$$

where  $V$  = volume, in cubic feet,  
 $S$  = total area, in square feet, and  
 $a_{av}$  = average absorption per square foot, in sabins.

A tabulation of sound absorption coefficients for various building materials and objects is shown in Table 12.1. The coefficients in this table were obtained upon small samples in chambers having a long reverberation time. In general, these measurements do not agree with those obtained under actual conditions in practice. That is, field measurements yield smaller values than laboratory measurements. However, the values of Table 12.1 show the relative absorption coefficients of the various materials. For a complete résumé of this subject see the Anniversary issue of the *Journal of the Acoustical Society of America*, Vol. 11, No. 1, Part 1, July, 1939.

There are a number of methods available for measuring the decay of sound in a room. Sabine and others have used an organ pipe and stop watch and have determined by ear the time required for the sound to decay to one millionth of its original intensity. At least two dozen instrumental methods have been developed for the measuring of the reverberation time of a room. At the present time, high speed level indicators and recorders appear to be the most suitable means for obtaining the reverberation time of a room. See Sec. 11.3A2.

The articulation <sup>9</sup> (see Sec. 11.12) of unamplified speech in auditoriums of various sizes as a function of the reverberation time is shown in Fig. 12.1.

<sup>8</sup> Eyring, C. F., *Jour. Acous. Soc. Amer.*, Vol. 1, No. 2, p. 217, 1930.

<sup>9</sup> Knudsen, V. O., *Jour. Acous. Soc. Amer.*, Vol. 9, No. 3, p. 175, 1938.

TABLE 12.1. ABSORPTION COEFFICIENTS OF VARIOUS BUILDING MATERIALS AND OBJECTS

No.	Material	Frequency						Author
		128	256	512	1024	2048	4096	
		Coefficient						
1	Draperies hung straight, in contact with wall, cotton fabric, 10 oz. per sq. yd. . . . .	.03	.04	.11	.17	.24	.35	P.S.
2	The same, velour, 18 oz. per sq. yd. . . . .	.05	.12	.35	.45	.38	.36	P.S.
3	The same as No. 2, hung 4" from wall. . . . .	.06	.27	.44	.50	.40	.35	P.S.
4	Felt, all hair, 1", contact with wall. . . . .	.09	.34	.55	.66	.52	.39	P.S.
5	Balsam wool 1" paper and cloth covering. . . . .	.06	.30	.56	.70	.56	.46	P.S.
6	Rock wool, 1" . . . . .	.35	.49	.63	.80	.83		V.K.
7	Carpet, 0.4" on concrete. . . . .	.09	.08	.21	.26	.27	.37	B.R.
8	Carpet, 0.4" on $\frac{1}{8}$ " felt on concrete. . . . .	.11	.14	.37	.43	.27	.25	B.R.
9	Cork board 1" . . . . .		.08	.30	.31	.28		F.W.
10	Firtex $\frac{1}{4}$ " on 2"x 4" wood studs 16" O.C. . . . .	.22	.21	.28	.31	.44	.55	V.K.
11	Masonite $\frac{1}{2}$ " board on 2"x 4" wood studs 16" O.C. . . . .	.16	.26	.34	.36	.30	.25	P.S.
12	Asbestos Felt. . . . .	.06	.14	.32	.25	.19	.18	W.S.
13	Acoustex Excelsior Tile 1" . . . . .	.11	.21	.53	.81	.81		B.S.
14	Acousti-celotex type A $\frac{13}{16}$ " 441 small holes per square foot. . . . .	.13	.28	.25	.23	.23	.23	F.W.
15	Wood sheeting, 0.8", pine. . . . .	.10	.11	.10	.08	.08	.11	W.S.
16	Brick wall, unpainted. . . . .	.024	.025	.081	.042	.049	.070	W.S.
17	Brick wall, painted. . . . .	.012	.013	.017	.020	.023	.025	W.S.
18	Concrete porous 2" block set in 1:3 cement, sand, mortar. . . . .	.15	.21	.43	.37	.39	.51	B.R.
19	Plaster, lime on wood lath on wood studs, rough finish. . . . .	.027	.046	.060	.085	.043	.056	P.S.
20	Plaster, gypsum on wood lath on wood studs, rough finish. . . . .	.016	.032	.039	.050	.030	.028	P.S.
21	Ozite $\frac{3}{4}$ " . . . . .	.09	.19	.28	.51	.56	.47	P.S.
	Individual Objects	Absorption Units in Sq. Ft. (Sabins)						
22	Audience, per person. . . . .	3.6	4.3	4.7	4.7	5.0	5.0	W.S.
23	Auditorium chairs solid seat and back. . . . .	.15	.22	.25	.28	.50		P.S.
24	Auditorium chairs upholstered. . . . .		3.1	3.0	3.2	3.4		F.W.

Abbreviations in the above table are as follows: W.S., Wallace Sabine; P.S., P. E. Sabine; F.W., F. R. Watson; V.K., V. O. Knudsen; B.R., Building Research Station, England; B.S., U. S. Bureau of Standards.

The average power of unamplified speech is much less than that required for distinct hearing. A greater reverberation time increases the intensity of sound at the auditor. However, increased reverberation decreases the intelligibility of speech. These two factors oppose each other with the

result that there is an optimum reverberation for each auditorium which yields maximum articulation as shown in Fig. 12.1. The obvious solution is the use of sound reenforcing equipment. The articulation for a weak average and loud talker without amplification as compared to amplified speech is shown in Fig. 12.1. By proper selection and placement of the loud speakers the articulation characteristic may be made considerably higher.

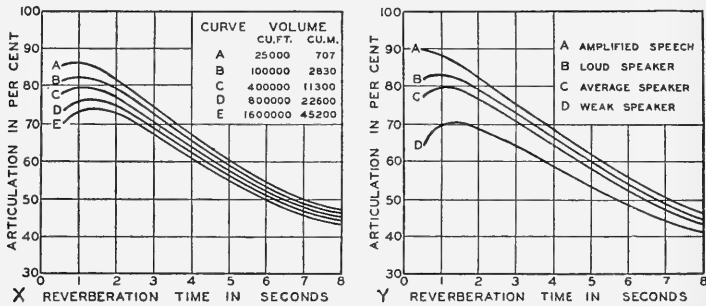

FIG. 12.1. *X*, the articulation of a speaker in auditoriums of various volumes. *Y*, the articulation of amplified speech, loud, average, and a weak speaker in an auditorium of 400,000 cubic feet.

**B. Sound Motion Picture Reproducing Systems<sup>10</sup>.** — The resultant sound energy density at the position of the auditor in a theatre depends upon the response and the directional characteristics of the loud speaker and upon the reverberation characteristics of the theatre. From the standpoint of the auditor, it may be said that there are two sources of sound energy, namely: the direct sound, which travels directly from the loud speaker to the auditor, and the generally reflected sound, which is reflected from the boundaries before reaching the auditor.

In a theatre free from acoustical difficulties, the energy density of the generally reflected sound is practically the same for all parts of the theatre. Therefore, the solution of the problem of achieving uniform energy density is to employ reproducers that will project the same direct sound energy to all parts of the theatre. The example which follows will illustrate how this may be accomplished by employing a directional loud speaker.

An elevation view of a reproducer in a theatre is shown in Fig. 12.2. The two extreme points to be supplied are indicated as *A* and *E*. If the loud speaker were nondirectional, the ratio of the direct sound energy densities

<sup>10</sup> Olson and Massa, *Jour. Soc. Mot. Pict. Eng.*, Vol. 23, No. 2, p. 63, 1934.

at the two points would be inversely proportional to the ratio of the squares of the distances from the reproducer. In this particular case, the difference in level would be 13 db. Obviously, such a large variation in sound intensity precludes the possibility of satisfactory reproduction over the entire area to be supplied. Therefore, a compensating means must be provided to counteract the variation of intensity with the distance from the reproducer. The directional loud speaker furnishes a solution of the problem.

The directional characteristics of the loud speaker are shown in Fig. 12.2. In this particular case, the difference of level for a point  $40^\circ$  from the axis,

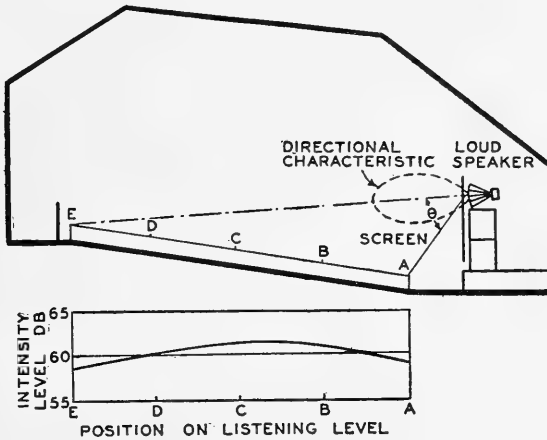

FIG. 12.2. Arrangement of the loud speaker for a sound motion picture reproducing system in a theatre. The graph shows the intensity level at points along the listening level.

as compared with the level at a point on the axis, is 13 db. The loud speaker is adjusted until the axis of the characteristic passes through the point  $E$ . Then the position of the loud speaker is adjusted until the angle  $\theta$  is  $40^\circ$ . The distribution over the distance under consideration is shown in Fig. 12.2. Summarizing, the variation of the sound pressure with the angle between the axis and the line joining the observation point and the reproducer has been employed to compensate for the decrease of the sound energy with the distance.

From the response frequency characteristic of the loud speaker the pressure at any distance  $r$  centimeters on the axis may be obtained from the following equation.

$$p = p_0 \frac{x_0}{r} \qquad 12.4$$

where  $p_0$  = pressure, in dynes per square centimeter, obtained at a distance  $x_0$ , in centimeters.

To obtain the pressure for a point not on the axis, the above equation must be multiplied by a factor obtained from the directional characteristic at this frequency. The direct radiation from the loud speaker can then be obtained for any point in the space.

The energy density, ergs per cubic centimeter, due to direct radiation from the loud speaker is

$$E_D = \frac{p_0^2 x_0^2 R_\theta^2}{r^2 \rho c^2} \quad 12.5$$

where  $R_\theta$  = ratio of the sound pressure at angle  $\theta$  to  $\theta = 0$ ,  
 $\rho$  = density of air, in grams per cubic centimeter, and  
 $c$  = velocity of sound, in centimeters per second.

To analyze the distribution of the direct sound over the area, the plan view of the theatre and the directional characteristics of the reproducer in the horizontal plane must be considered. The angle subtended at the loud speaker by the area to be covered will determine the effective dispersion angle of the reproducer. The sound energy density due to the generally reflected sound is a function of the absorption characteristics of the theatre and the power output of the reproducer. The sound energy density, ergs per cubic centimeter, due to the generally reflected sound is given by

$$E_R = \frac{4P}{caS} [1 - e^{(cs [\log_e (1-a)] t)/4V}] (1 - a) \quad 12.6$$

where  $a$  = the average absorption per unit area, absorption coefficient,  
 $S$  = the area of the absorbing materials, in square centimeters,  
 $V$  = the volume of the room, in cubic centimeters,  
 $t$  = time, in seconds,  
 $c$  = the velocity of sound, in centimeters per second, and  
 $P$  = the power output of the loud speaker, in ergs per second.

The total sound energy density at any point in the theatre will be the sum of the direct and the generally reflected sound, and may be expressed by

$$E_T = E_D + E_R \quad 12.7$$

On pages 282 and 283 a method was outlined, employing directional loud speakers, for obtaining a uniform energy distribution of the direct sound. The energy density of reflected sound, as shown by equation 12.6, is independent of the observation point. As a consequence, by employing



directional loud speakers, the total sound energy density will be the same in all parts of the theatre. Furthermore, the effective reverberation of the reproduced sound (the ratio of generally reflected to direct sound) is the same for all parts of the theatre.

The distribution of a reproducing system in a theatre is usually checked by means of a response measuring system. The plan and elevation view of a typical theatre is shown in Fig. 12.3. The response characteristics for positions *A*, *B*, *C* and *D* on the orchestra level and *E* and *F* on the balcony level are shown in the respective graphs. These characteristics show that

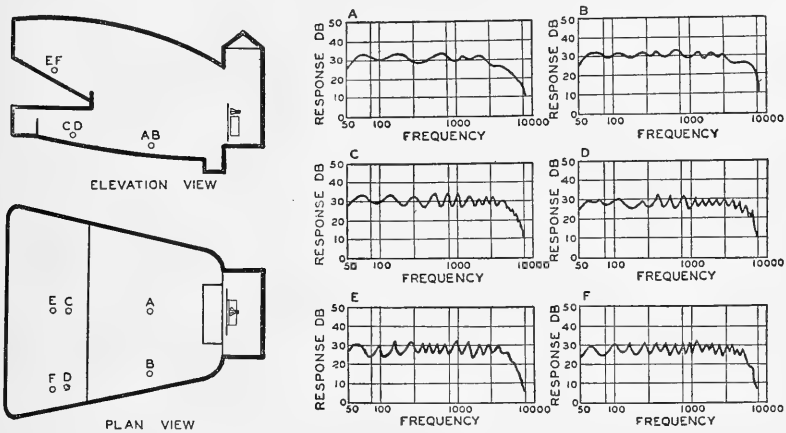

FIG. 12.3. A cross-sectional elevation and plan view of a theatre equipped with a loud speaker for the reproduction of sound motion pictures. The graphs show the response frequency characteristics in various parts of the theatre.

it is possible to obtain uniform response in all parts of the theatre by following the procedures outlined in the preceding discussions.

In sound motion picture reproduction the loud speakers are usually placed behind a perforated screen upon which the picture is projected, Fig. 12.3. Sound is transmitted through the screen by actual vibration of the screen and by the perforations. In general the transmission by vibration is negligible. The perforations usually consist of small circular holes about a millimeter in diameter. These holes form an inertance and acoustic resistance. See Secs. 5.3 and 5.11. The resistance of the holes introduces attenuation which is usually small. The acoustic reactance due to the inertance increases with frequency, and therefore the attenuation increases with frequency. The response characteristic of the screen shows more or less constant attenuation in the low and mid frequency ranges due to the

acoustic resistance of the holes. However, the attenuation in the high frequency range increases with frequency due to the acoustic reactance of the holes. The inertance increases with the thickness of the screen and decreases as the ratio of the open to closed area of the screen increases. For example, for 3 db attenuation at 10,000 cycles the hole area is usually 15 to 20 per cent of the screen area. If the hole area is 7 to 15 per cent the attenuation is about 6 db at 10,000 cycles and about 3 db at 5000 cycles. These examples show that the screen is an important problem in wide range reproduction.

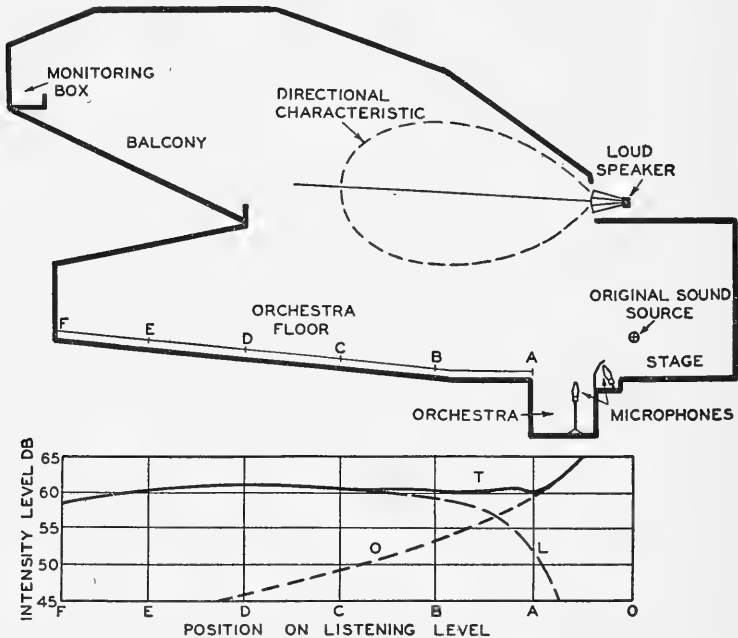

FIG. 12.4. Arrangement of the components of a sound re-enforcing system in a theatre. The graph shows the intensity level due to direct sound at the points indicated on the orchestra floor. Curve *O*, the intensity due to the original source of sound. Curve *L* the intensity level due to the loud speaker. Curve *T* the resultant intensity level.

C. *Sound Re-enforcing Systems*<sup>11</sup>. — A large theatre equipped with a sound re-enforcing system is shown in Fig. 12.4. Microphones are concealed in the footlight trough for collecting the sound on the stage and others are placed in appropriate positions in the orchestra. The loud speakers are located above the stage in the proscenium arch. The volume

<sup>11</sup> Olson, H. F., *RCA Review*, Vol. 1, No. 1, p. 44, 1936.

control and microphone mixing system is usually located in a box or booth in the balcony.

In this system there are two sources of direct sound, namely: the original sound and the augmented sound from the loud speakers. Usually the intensity of the original sound issuing from the stage will be quite satisfactory on the orchestra floor near the stage and, as a consequence, it is not necessary to augment the sound in this portion of the theatre. As the distance from the stage increases, the original sound intensity decreases. To make up for this loss the sound energy from the loud speakers must progressively increase towards the rear of the theatre. It is the purpose of this section to describe and analyze a sound re-enforcing system.

Consider the system shown in Fig. 12.4. If the distance between the source of the original sound and the point of observation is  $r$  centimeters, the energy density, in ergs per cubic centimeter, due to the direct sound is

$$E_{D1} = \frac{P_{D1}}{4\pi r^2 c} \quad 12.8$$

where  $P_{D1}$  = power output of the sound source, in ergs per second, and  
 $c$  = velocity of sound, in centimeters per second.

The sound intensity or intensity may be obtained from the energy density by multiplying it by the velocity of sound. The reference intensity for intensity level comparisons is  $10^{-9}$  ergs per second or  $10^{-16}$  watts per square centimeter. The intensity level of a sound is the number of decibels above the reference level.

The intensity level on the orchestra floor resulting from a sound source as, for example, a speaker or singer on the stage, is given by the curve  $O$  of Fig. 12.4. It will be seen that the intensity level of the direct sound in the rear of the house is inadequate for good hearing. The arrangement and characteristics of the sound re-enforcing system should be chosen so that the resultant intensity level, due to the direct sound from the combination of the original source and the loud speakers, is the same for all parts of the audience.

The energy density, in ergs per cubic centimeter, at a distance  $r$  centimeters due to direct radiation from the loud speaker, from equation 12.5, is

$$E_{D2} = \frac{p_0^2 \kappa_0^2 R_0^2}{r^2 \rho c^2} \quad 12.9$$

where  $p_0$  = pressure, in dynes per square centimeter, obtained at a distance  $\kappa_0$  centimeters,

$R_\theta$  = ratio of the pressure at the angle  $\theta$  to  $\theta = 0$ ,  
 $\rho$  = density of air, in grams per cubic centimeter, and  
 $c$  = velocity of sound, in centimeters per second.

The problem is to select a loud speaker with suitable directional characteristics, see Sec. 12.2*B*, and then to adjust the power output and orientation so that the sum  $E_{D1} + E_{D2}$  of equations 12.8 and 12.9 is a constant for all parts of the listening area of the theatre. The intensity level on the orchestra floor, in Fig. 12.4, due to the direct sound from a loud speaker having directional characteristics as shown, is given by the curve  $L$ . The intensity level due to the combination of the original sound and augmented sound from the loud speaker is shown by curve  $T$  of Fig. 12.4. The resultant intensity is quite uniform over the orchestra floor. A similar analysis will show that the intensity level in the balcony is also relatively uniform. Further consideration of the characteristic of Fig. 12.4 shows that the total intensity level characteristic remains uniform when the output of the loud speakers, that is, the gain in augmented sound, is varied over wide limits.

The energy density, in ergs per cubic centimeter, in the theatre due to generally reflected sound is

$$E_R = \frac{4(P_{D1} + P_{D2})}{caS} [1 - e^{(cS [\log_e (1-a)] t)/4V}] (1 - a) \quad 12.10$$

where  $a$  = average absorption per unit area, absorption coefficient,  
 $S$  = area of absorbing materials, in square centimeters,  
 $V$  = volume of the theatre, in cubic centimeters,  
 $t$  = time, in seconds,  
 $c$  = velocity of sound, in centimeters per second,  
 $P_{D1}$  = power output of the original sound, in ergs per second, and  
 $P_{D2}$  = power output of the loud speaker, in ergs per second.

The aid obtained from reflected sound in a directional sound re-enforcing system is relatively small, ranging from 2 to 6 db.

The microphones for collecting the sounds are usually concealed in the footlight trough.<sup>12</sup> By employing directional loud speakers, as outlined above, the sound level at the microphones due to the loud speakers is low and thereby reduces the tendency of acoustic feedback or regeneration in the reproducing system. In large theatres, having an expansive stage, the pickup distance will be very large. Consequently, the sound which reaches the microphones from the original source will be small and will require con-

<sup>12</sup> Olson, H. F., *RCA Review*, Vol. 1, No. 1, p. 49, 1936.

siderable amplification which increases the tendency for feedback. In cases where difficulties are experienced, due to acoustic feedback, a further reduction in coupling can be obtained by employing directional microphones. Furthermore, the stage collecting system should not be responsive to sound originating in the orchestra or audience. In case the microphones are located in the footlights, the shielding effects of the apron, together with a velocity microphone, Fig. 12.5, are in general sufficient to accomplish this objective. Where it is impossible to shield the microphones in this manner the unidirectional microphone has been found to be very useful, as will be seen from a consideration of the directional characteristics of this microphone shown in Fig. 12.5.

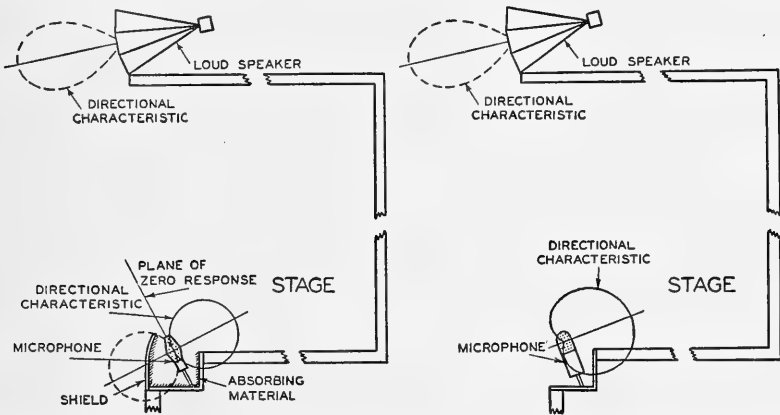

FIG. 12.5. Arrangements depicting the use of directional loud speakers and microphones for reducing feedback between the loud speaker and the microphone. The arrangement on the left employs a velocity microphone. A shield is used to reduce sound pickup from the orchestra and audience. The arrangement on the right employs a unidirectional microphone. The directional characteristics of this microphone are particularly adapted for collecting sounds on the stage and discriminating against sounds coming from the orchestra and audience.

In order to "cover" the action from any part of the stage several microphones are employed, usually spaced at intervals of ten feet. The output of each stage microphone and orchestra microphone is connected to a separate volume control on the mixer panel. This mixer and volume control system is located in the monitoring box. By means of this system the operator follows the action by selecting the microphone nearest the action on the stage. The operator also controls the ratio of the volume of the stage sound to that received from the orchestra when there is an orchestral accompaniment as well as the overall intensity of the augmented sound.

The monitoring box is usually located in the rear balcony, the position which is the most susceptible to the augmented sound and one which also furnishes a good view of the action.

D. *Reverberation Time of a Theatre for the Reproduction of Sound.* — The optimum reverberation time of theatres for the reproduction or the reinforcement of sound as a function of the volume of the auditorium, for a

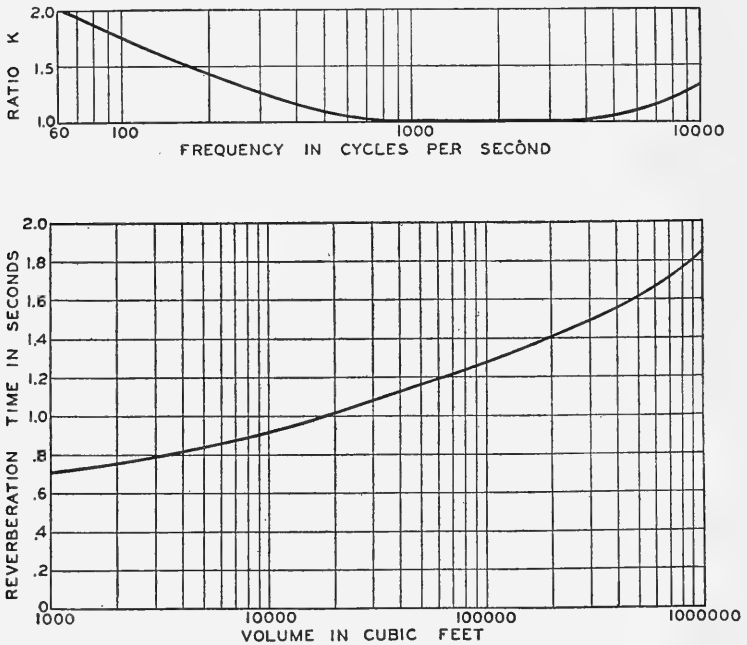

FIG. 12.6. Lower graph shows the optimum reverberation time for a theatre as a function of the volume for 1000 cycles. Upper graph shows the relation between the reverberation time and the frequency, that is, the reverberation time at other frequencies is obtained by multiplying by  $K$ .

frequency of 1000 cycles, is shown in the lower graph of Fig. 12.6. The reverberation time for other frequencies can be obtained by multiplying by the factor  $K$ , obtained from the upper graph of Fig. 12.6. The reverberation time increases at the lower and higher frequencies so that the aural rate of decay of pure tones will be approximately the same for all frequencies. See Secs. 13.4 and 13.5 and Figs. 13.1 and 13.2.

E. *Power Requirements for Reproducing Systems*<sup>13</sup>. — The power require-

<sup>13</sup> Olson, H. F., *RCA Review*, Vol. 1, No. 1, p. 49, 1936.

ment is an important factor in the motion picture and sound re-enforcing systems. The minimum intensity which these systems should be capable of producing is 80 db. 0 db = .0002 dyne per square centimeter. The graph of Fig. 12.7 shows the acoustic power required, as a function of the volume, in auditoriums to produce a level of 80 db. In large auditoriums where the orchestra is also re-enforced the power available should be greater. For example, to render full artistic appeal, the system should be capable

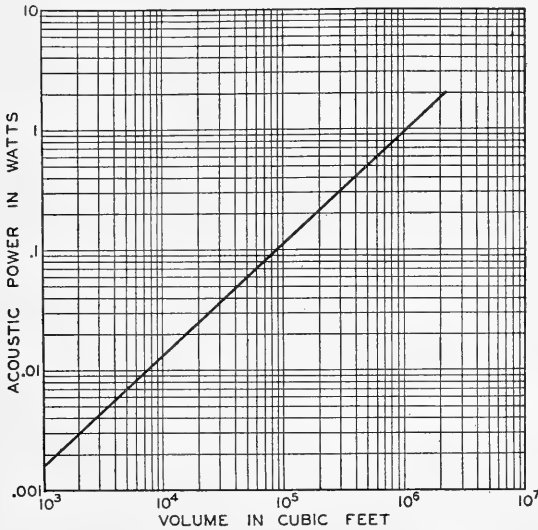

FIG. 12.7. Acoustic power required to produce an intensity level of 80 db as a function of the volume of the auditorium.

of producing a level up to 100 db. This means a power of 100 times that shown in Fig. 12.7. Systems for producing this sound level without distortion usually require special amplifiers and loud speakers.

F. *Noise at Different Locations.* — The ease with which speech may be heard and understood depends upon the noise conditions as well as upon the other characteristics of a sound reproducing system. The full artistic effects of musical reproduction can only be obtained with a wide volume range. This volume range, of course, depends upon the noise level at the listening point. The tolerable level of the noises generated in any reproducing system depends upon the noise level at the reproducing point.

The noise level<sup>14</sup> of residences, business offices and factories is shown in

<sup>14</sup> Seacord, D. F., *Elec. Eng.*, Vol. 58, No. 6, p. 255, 1939.

Fig. 12.8. The reference level is  $10^{-16}$  watts per square centimeter. It will be seen that there is a wide variation in the noise from one location to another. For example, 5 per cent of the residences have a noise level of 32 db while another 5 per cent have a noise level of 50 db. The factory noise levels were taken in two parts of the country. The higher level is for the Eastern part of the United States while the lower level is for the Midwest. This is probably due to the different types of manufacturing.

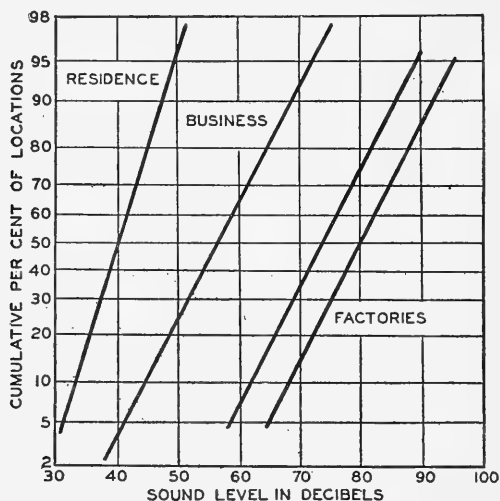

FIG. 12.8. Room noise in residence, business, and factory locations. (After Seacord.)

The noise level in various locations is shown in Table 12.2. All data were obtained with a noise meter employing the characteristics of Fig. 11.18.

G. *Public Address Systems*<sup>15</sup>. — The term public address system ordinarily refers to a sound reproducing apparatus for use in addressing large assemblages. There are innumerable specific applications of sound reproducing apparatus for this purpose. The problems in all these situations are practically the same. It is the purpose of this section to consider some typical examples of the use of public address systems.

Regardless of the size of the athletic field or baseball park, a public address system is useful for informing those in the stands of what is happening on the field. In general, the chief requirements are as follows: uniform distribution of sound intensity in all parts of the stand, adequate

<sup>15</sup> Olson, H. F., *RCA Review*, Vol. 1, No. 1, p. 49, 1936.



power to override any anticipated noise level of the maximum crowd, and facilities available for microphones at predetermined points.

A large stadium equipped with a public address system is illustrated by the left portion of Fig. 12.9. Due to the size and configuration of the audience area it is practically impossible to obtain satisfactory sound level and coverage with a single loud speaker. Consequently, the loud speakers

TABLE 12.2. NOISE LEVELS FOR VARIOUS SOURCES AND LOCATIONS

Source or Description of Noise	Noise Level in Decibels
Threshold of Pain.....	130
Hammer Blows on Steel Plate..... 2 ft.	114
Riveter..... 35 ft.	97
Factory.....	78
Busy Street Traffic.....	68
Large Office.....	65
Ordinary Conversation..... 3 ft.	65
Large Store.....	63
Factory Office.....	63
Medium Store.....	62
Restaurant.....	60
Residential Street.....	58
Medium Office.....	58
Garage.....	55
Small Store.....	52
Hotel.....	42
Apartment.....	42
House, Large City.....	40
House, Country.....	30
Average Whisper..... 4 ft.	20
Quiet Whisper..... 5 ft.	10
Rustle of Leaves in Gentle Breeze.....	10
Threshold of Hearing.....	0

are placed at intervals near the boundary of the field sufficiently close together so that uniform response is obtained in the horizontal plane. The elevation view of Fig. 12.9 shows how uniform sound distribution is obtained in the vertical plane by means of the directional characteristics. The microphones are usually located either on the field or in the press box.

A baseball field equipped with a public address system is illustrated by the right portion of Fig. 12.9. As contrasted to the stadium, here a single loud speaker station is used to supply the entire audience area. The distance between the loud speakers and the auditors is very large. Therefore,

the vertical coverage angle is very small, which means that practically any system will have a distribution angle sufficiently broad to supply the required vertical spread. However, for conservation of power the vertical spread of the loud speaker should correspond to the vertical angle subtended by the audience at the loud speaker. Since the distance of those nearest the loud speaker to those farthest removed (that is, considering the vertical angle only) is very nearly the same, the sound intensity from the loud speaker will be practically the same for all parts of the audience through any vertical plane and the use of compensation by means of the directional characteristics for change in distance in the vertical plane to obtain uniform response is not necessary. In the horizontal plane the spread of the loud

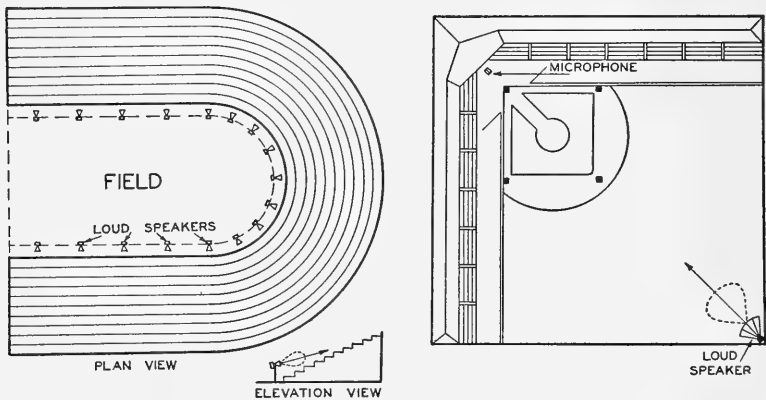

FIG. 12.9. Two arrangements of sound systems for addressing assemblages in large grandstands. For the stadium on the left a large number of loud speakers are used, each loud speaker covering a small portion of the total area. For the ball park on the right, a single loud speaker cluster is used to supply the entire grandstand.

speaker should correspond to the angle subtended by the stands at the loud speaker. Since the center line is farthest removed, a directional characteristic of the shape shown is necessary for obtaining the same sound level in all parts of the grandstand. To eliminate any difficulties due to feedback, a velocity microphone is used and oriented so that the plane of zero reception passes through the loud speaker system.

The sound level required for public address work of the type considered above will be determined by the noise level of the maximum crowd. In general, it is not practical to employ a system with sufficient power to override the sound level during cheering, applause, etc. However, the power should be sufficient to override the general noise during relatively

quiet intervals. The noise level may be determined by means of a noise meter. The power available should be sufficient to produce a minimum sound level of 80 db or, for very noisy conditions, 20 to 30 db above the noise during the relatively quiet intervals. In the two examples cited above and, in fact, for all outdoor public address work, the only consideration is direct sound. The problem is to select amplifiers and loud speakers with characteristics which will deliver the required sound level over the distances and areas considered. The steps in the selection of a system may be as follows: First, the directional characteristics should be determined, as outlined in the preceding discussion, so that uniform response is obtained over the audience area. Second, either a single or a group of loud speakers having the desired directional characteristics should be selected.

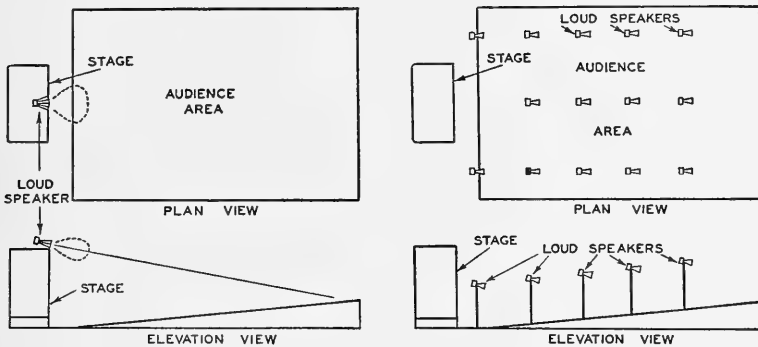

FIG. 12.10. Two arrangements of sound re-enforcing systems for an outdoor theatre. The arrangement on the left employs a single loud speaker having suitable directional characteristics to produce a uniform intensity level over the audience area. The arrangement on the right employs a number of loud speakers, each covering a small portion of the audience.

Third, the response characteristic of the system on the axis at a specified input and distance should be available to show the amplifier power required to supply the desired intensity level. Fourth, the power handling capacity of the loud speakers and amplifiers should be adequate to supply the required intensity level.

Two types of sound re-enforcing installations for an outdoor theatre are illustrated in Fig. 12.10. The system depicted on the left employs a single loud speaker station. The same procedure for obtaining uniform sound coverage and adequate intensity level of the direct sound as used in the preceding considerations is applicable in this case. The system depicted on the right employs a large number of loud speakers, each one supplying a small portion of the audience. The directional characteristics of the loud

speakers should be selected so that each individual area is adequately supplied. Cognizance must be taken of the energy supplied from adjacent loud speakers.

There are certain advantages in each system. In the case of the single loud speaker system, better illusion is obtained because the augmented sound appears to come from the stage. On the other hand, the intensity level outside the audience area in a backward direction falls off very slowly. At a distance equal to the length of the audience area the level is only 6 db lower than that existing in the audience area. In certain locations the sound levels produced by such systems will cause considerable annoyance to those located in the vicinity of the theatre. By dividing the theatre area into small plots, each supplied by a loud speaker, and by directing the loud speakers downward, the sound intensity level outside the audience area will be considerably lower than in the case of the single loud speaker station and usually eliminates any annoyance difficulties. The short sound projection distance is another advantage of the multiple loud speaker system.

The above typical examples of outdoor public address and sound reinforcing systems illustrate the principal factors involved in this field of sound reproduction.

H. *General Announce and Paging Systems*<sup>16</sup>. — General announce systems are useful in factories, warehouses, railroad stations, airport terminals, etc. A typical installation is depicted on the left portion of Fig. 12.11. For this type of work intelligibility is more important than quality. The deleterious effect of reverberation upon articulation can be reduced, and a better control of sound distribution can be obtained, by reducing the low frequency response of the system. Furthermore, the cost of the amplifiers and loud speakers is also reduced by limiting the frequency range. To find the power required, the sound intensity level under actual operating conditions should be determined. The system should be designed to produce an intensity level 20 to 40 db above the general noise level. Under no conditions should the system be designed to deliver an intensity level of less than 80 db. The loud speakers should be selected and arranged following an analysis similar to that outlined in the preceding sections, so that uniform sound distribution and adequate intensity levels are obtained.

For certain types of general announce, paging and sound distributing installations, as is used in schools, hospitals, department stores, hotels, etc., the intensity level required is relatively low and the volume of the average room is usually small. For most installations of this type, save in noisy

---

<sup>16</sup> Olson, H. F., *RCA Review*, Vol. 1, No. 1, p. 49, 1936.

locations, an intensity level of 70 db is more than adequate. Higher intensity levels tend to produce annoyance in adjacent rooms. From a consideration of the data of Fig. 12.7, it will be seen that the power requirements for the loud speakers will be small. To blend with the furnishings of the room, it is desirable to mount the loud speakers flush with the wall surface. Therefore, for these applications, a direct radiator loud speaker of the permanent magnet dynamic or magnetic type is most suitable. In this connection it should be mentioned that these loud speakers have a very low efficiency, being of the order of 1 per cent as compared to 25 per cent to 50 per cent for the horn loud speakers.

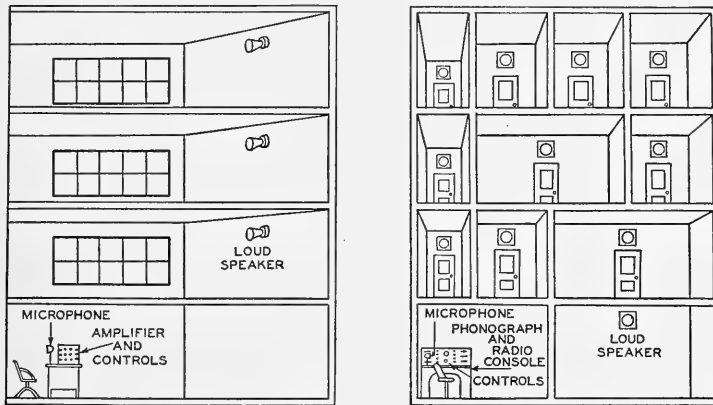

FIG. 12.11. Two uses of call, general announce, and sound distributing systems. On the left, a high efficiency horn is used to obtain a high sound level over a large floor area as in a factory or warehouse. On the right, small direct radiator loud speakers are used to supply the small rooms at a relatively low level as in paging, announcing, and centralized radio installations used in hospitals, hotels, or schools.

For large rooms requiring large acoustic outputs it is more economical to use a high efficiency loud speaker and effect a corresponding reduction in the power amplifier requirements. On the other hand, for an installation of the type depicted on the right side of Fig. 12.11 and requiring a large number of units, it is more economical to use relatively inefficient low cost loud speakers and correspondingly larger amplifiers.

I. *Intercommunicating Systems.* — Intercommunicating systems are loud speaking telephones for use in communicating between two rooms. The more elaborate systems are similar to the general announce system described in Sec. 12.2H with the addition of microphone positions in more than one room. The simplest system consists of two units for use between

two stations. The master unit contains an amplifier, microphone, loud speaker, and a talk-listen switch. The remote unit consists of a microphone, loud speaker, and talk-listen switch. In some of these systems the loud speaker with suitable electrical compensation is also used as a microphone. Additional stations and appropriate switching systems may be added for communicating between a number of rooms. The voice currents are carried in two ways: in one by direct wire, and in the other by using a high frequency carrier on the power mains. The latter system does not require wiring but has the disadvantage that in large buildings having several separate systems cross-talk may occur.

J. *Radio Receiver Operating in a Living Room*<sup>17</sup>. — The radio receiver and phonograph represent by far the largest number of complete reproducing systems. For this reason, the performance of a radio receiver in a room is an extremely important problem. Equations 12.4, 12.5 and 12.6 for

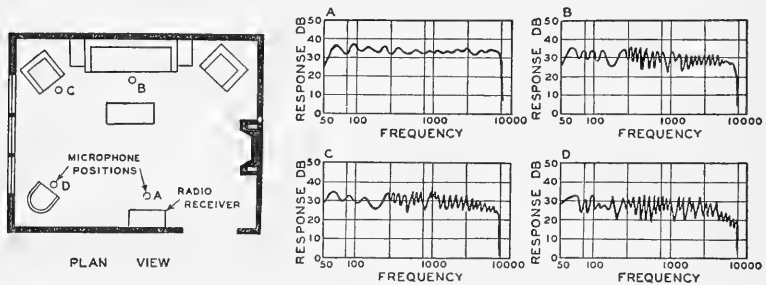

FIG. 12.12. A plan view of a living room with a radio receiver. The graphs show the response frequency characteristics for various positions in the room.

the direct and reflected sound are applicable to a radio receiver in a room. In the case of a theatre it is possible to adjust the loud speakers so that the direct sound is the same in all parts of the auditorium. It is not practical to arrange the loud speakers in a radio receiver so that there will be no variation of the direct sound with distance. In view of the rather small distances and relatively small volume of the room this is not very important. It is important, however, that the directional characteristic be independent of the frequency and sufficiently broad to send direct sound into all listening areas.

The response frequency characteristics of a good radio receiver taken at various listening positions in a typical living room are shown in Fig.12.12.

<sup>17</sup> Olson and Massa, "Applied Acoustics," 2nd Ed., p. 401, P. Blakiston's Son and Co., Philadelphia, 1939.

Graph *A* shows the response frequency characteristic very close to the receiver and, therefore, indicates the direct sound output. The directional characteristics of this receiver were uniform over an angle of  $120^\circ$ . The sharp variations in response frequency characteristics taken in other parts of the room are due to the reflected sound. The direct sound energy density and the reflected sound energy density are approximately equal at a distance of five feet from the receiver for the average living room and average reproducer. It is interesting to note that the response frequency characteristics taken in various positions in the room have the same shape as that taken very close to the receiver. The reverberation time characteristic of this room was quite uniform with respect to frequency, therefore, the reflected sound does not vary appreciably with frequency since the output of the receiver is independent of the frequency. See equation 12.6.

The response frequency characteristics upon the ears, Fig. 13.1, to be considered in Sec. 13.4, show that corresponding to the intensity of a 1000 cycle note there is an intensity at another frequency that will sound as loud. These characteristics show that if the sound is reproduced at a lower level than that of the original sound it will appear to be deficient in low frequency response. In general, the reproduction level in the home is much lower than the level of the original reproduction. In order to compensate for the low frequency deficiency, the volume control in most radio receivers and phonographs is designed so that the low frequency response is accentuated in an inverse ratio to the relative sensitivity of the ear in going from the original level to the lower level of reproduction. This type of volume control is termed an acoustically compensated volume control.<sup>18</sup>

K. *Radio Receiver Operating in an Automobile.*—The loud speaker in an automobile is usually placed in one of the following three positions: in the header (above the windshield), in the instrument panel, and on the fire wall or dash. The header position gives somewhat better distribution of high frequency response in the back seat than the other two positions. However, the low frequency response of a loud speaker mounted in the header is usually attenuated due to the small volume behind the loud speaker. The dash or fire wall position gives good distribution of high frequency response in the front seat but not as good distribution in the back seat. The low frequency response in this position can be made very good by employing a large loud speaker case or by venting the back of the case into the engine compartment. Sometimes a combination of a low frequency dash loud speaker and a high frequency header or instrument

---

<sup>18</sup> Wolff and Cornell, *Electronics*, Vol. 6, No. 2, p. 50, 1933.

panel loud speaker is employed. At the present time the favored position for the loud speaker appears to be in the instrument panel because in this location the radio receiver, loud speaker, and controls may be combined into a single compact unit. The distribution of sound is excellent in the front seat and good in the back seat. The stiffness presented to the back of the cone is small because the entire radio receiver case volume is used to enclose the back of the loud speaker. Therefore, the response may be maintained in the low frequency range. In order to reduce annoyance from hiss generated in the receiver due to the relatively weak signals

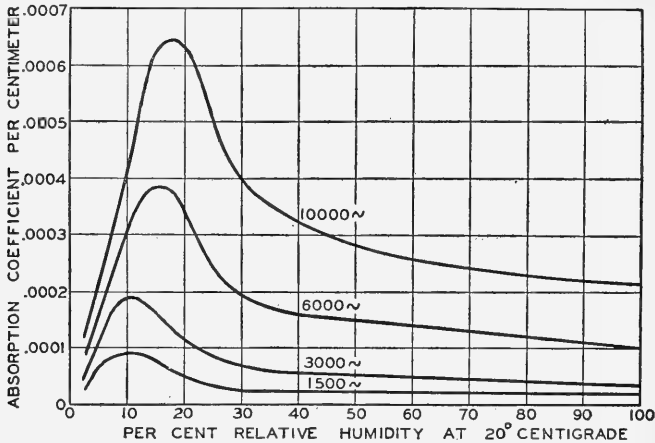

FIG. 12.13. Curves showing the absorption of a plane sound wave in passing through air, at 20° C. for different frequencies, as a function of the relative humidity. The intensity after a plane wave has travelled a distance  $x$  centimeters is  $I_0 e^{-mx}$ , where  $I_0$  is the intensity at  $x = 0$  and  $m$  is the coefficient given by the above graph. (After Knudsen.)

delivered by the antenna, it is customary to attenuate the response above 4500 cycles. The low frequency response in reproduction is usually masked at the higher speeds by wind noise and road rumble. Also see Sec. 11.3A7.

L. *Absorption of Sound in Passing Through Air.* — The absorption<sup>19</sup> of a plane progressive sound wave in passing through air may be several times that predicted by the classical theory. The anomalous absorption is primarily dependent upon the humidity, although it is also affected by impurities such as H<sub>2</sub>O, H<sub>2</sub>, H<sub>2</sub>S and NH<sub>3</sub>. This, of course, means that there may be considerable frequency discrimination of the reproduced sound in large theatres where the sound travels a long distance. In addition, the reverberation time will be reduced at the higher frequencies. The co-

<sup>19</sup> Knudsen, V. D., *Four. Acous. Soc. Amer.*, Vol. 6, No. 4, p. 199, 1935.



efficient per centimeter for 1500, 3000, 6000 and 10,000 cycles as a function of the humidity is shown in Fig. 12.13.

M. *Sound Transmission through Partitions*<sup>20, 21, 22, 23, 24, 24A</sup>. — The problem of sound transmission through partitions and walls is complicated because of the many factors involved. The problem of the mass controlled single wall partition is very simple. The sound insulation of this type of partition is proportional to the mass and frequency. For the usual building materials and walls of ordinary dimensions supported at the edges, the problem is that of the clamped rectangular plate with distributed resistance throughout the plate and lumped damping at the edges. Obviously, the performance of this system depends upon the size, the ratio of the two linear dimensions, the weight of the material, the damping in the material and the edge supports. This type of problem is not amenable to an analytical solution.

The transmittivity of a partition is defined as the ratio of the intensity in the sound transmitted by the partition to the intensity in the sound incident upon the partition. The transmission loss, in decibels, introduced by the partition is given by

$$\text{T.L.} = 10 \log_{10} \frac{I_i}{I_t} = 10 \log_{10} \frac{1}{\tau} \quad 12.11$$

where  $I_i$  = intensity of the incident sound,

$I_t$  = intensity of the transmitted sound, and

$\tau$  = transmittivity or transmission coefficient.

The coefficient of transmission  $\tau$  is a quantity which pertains alone to the partition and is independent of the acoustic properties of the rooms which it separates.

The reduction factor is the ratio of the sound energy density in the room containing the sound source to the sound energy in the adjoining receiving room. The reduction factor, in decibels, is given by

$$\text{R.F.} = \text{T.L.} + 10 \log_{10} \frac{A}{S} \quad 12.12$$

where  $A$  = total absorption in the receiving room, and

$S$  = area of the test pattern.

<sup>20</sup> Rayleigh, "Theory of Sound," Macmillan Co., London.

<sup>21</sup> Eckhardt and Chrisler, Bureau of Standards, Paper No. 526.

<sup>22</sup> Knudsen, "Architectural Acoustics," John Wiley and Sons, New York, 1932.

<sup>23</sup> Sabine, "Acoustics and Architecture," McGraw Hill Book Co., New York, 1932.

<sup>24</sup> Watson, "Acoustics of Buildings," John Wiley and Sons, New York, 1923.

<sup>24A</sup> Morrical, K. C., *Jour. Acous. Soc. Amer.*, Vol. XI, No. 2, p. 211, 1939.

Equation 12.12 shows that the reduction is due to both the loss introduced by the partition and the absorption in the receiving room.

The choice of a partition for insulating a room against sound involves a number of considerations. Some of the factors are the frequency distribution and intensity level of the components of the objectionable sound, the transmission frequency characteristics of the partition, the ambient noise or sound level in the receiving room which will mask the objectionable sound and the response frequency characteristics of the ear.

Measurements have been made by various investigators upon the transmission by single partitions. The results of these measurements are shown in Table 12.3.

TABLE 12.3. NOISE REDUCTION THROUGH VARIOUS STRUCTURES

Material	Weight in Lbs. per Sq. Ft.	Reduction Factor in DB					T.L. in DB	Author
		Frequency						
		128	256	512	1024	2048		
Aluminum, .025" . . . . .	.35		18	13	18	23	16	B.S.
Iron, .03" galvanized . . . . .	1.2		25	20	29	35	25	B.S.
Lead, $\frac{1}{8}$ " . . . . .	8.2		31	27	37	44	32	B.S.
Plywood, $\frac{1}{4}$ " . . . . .	.73		21	21	25	26	21	B.S.
Celotex, Standard $\frac{1}{4}$ " . . . . .	.30		14	15	18	24	15	B.S.
Celotex, Standard $\frac{1}{2}$ " . . . . .	.66		22	17	23	27	20	B.S.
Hair Felt, 1" . . . . .	.75	4.9	4.6	6.0	7.1	6.7		P.E.S.
Hair Felt, 4" . . . . .		7.5	12.5	15	19	19		P.E.S.
Wood Studs, Wood Lath, Lime Plaster . . . . .	18	27	29	38	47	43	43	P.E.S.
Tile, 2" Gypsum . . . . .	20	25	34	44	51	63	48	P.E.S.
Tile, Clay 6"x 12"x 12" Plastered both sides . . . . .	37		41	35	45	52	40	B.S.
Brick, 8" Plastered both sides . . . . .	87		50	48	55	63	50	B.S.
Door, Light 4 Panel . . . . .		13	16	20	23	22	22	P.E.S.
Door, Oak . . . . .		15	18	23	26	25	25	P.E.S.
Door, Steel $\frac{1}{4}$ " . . . . .		25	27	31	36	31	35	P.E.S.
Window Glass, Plate $\frac{1}{4}$ " . . . . .	3.5		33	31	33	35	30	B.S.
Window Glass, Small Panes $\frac{3}{16}$ " . . . . .		19	20	24	31	28	29	P.E.S.

The abbreviations in the above table are as follows: B.S. — Bureau of Standards; P.E.S. — P. E. Sabine.

The mass controlled partition with air between the partition elements is a low pass filter in which the mass of the wall is the series element and the volume between the partitions is the shunt element. See Sec. 4.10D. The partitions in this case are mounted in edge supports which allow freedom of motion without cracks which would pass air borne sound.

N. *Nonlinear Distortion Generated in a Plane Sound Wave.* — A sound wave of large amplitude cannot be propagated in air without a change in

wave form. Physically the distortion is due to the nonlinearity of the atmosphere. The harmonics generated in an exponential horn have been considered in Sec. 8.3A. The distortion generated in a sound wave propagated in air is of interest in certain problems involving high sound levels.

The ratio of the second harmonic, generated in a plane sound wave, in traversing a distance  $x$ , to the fundamental is

$$\frac{p_2}{p_1} = \frac{(\gamma + 1)2\pi p_1 f x}{2\sqrt{2}\gamma p_0 c} \quad 12.13$$

where  $\gamma$  = ratio of specific heats, 1.4 for air,

$p_1$  = fundamental sound pressure, in dynes per square centimeter,

$p_0$  = atmospheric pressure, in dynes per square centimeter,

$p_2$  = second harmonic sound pressure, in dynes per square centimeter,

$c$  = velocity of sound, in centimeters per second,

$f$  = frequency, in cycles per second, and

$x$  = distance, in centimeters.

The distance which a plane wave must travel to produce 1 per cent distortion for a pressure of 1, 10 and 100 dynes, for frequencies of 100, 1000 and 10,000 cycles, is shown below.

Pressure in Dynes per Square Centimeter	Distance in Centimeters		
	100 cycles	1000 cycles	10,000 cycles
1	$9 \times 10^5$ cm	$9 \times 10^4$ cm	$9 \times 10^3$ cm
10	$9 \times 10^4$ cm	$9 \times 10^3$ cm	$9 \times 10^2$ cm
100	$9 \times 10^3$ cm	$9 \times 10^2$ cm	90 cm

**12.3. Collection of Sound.** — A. *Sound Collecting System*<sup>25, 25A</sup>. — When a source of sound is caused to act in a room, the first sound that strikes a collecting system placed in the room is the sound that comes directly from the source without reflection from the boundaries. Following that comes sound that has been reflected once, twice and so on, meaning that the energy density of the sound increases with the time, as the number of reflections increase. Ultimately, the absorption of energy by the boundaries equals the output of the source and the energy density at the col-

<sup>25</sup> Olson, H. F., *Proc. Inst. Rad. Eng.*, Vol. 21, No. 5, p. 655, 1933.

<sup>25A</sup> Olson and Massa, "Applied Acoustics," P. Blakiston's Son and Co., Philadelphia.

lecting system no longer increases; this is called the steady state condition. Therefore, at a given point in a room there are two distinct sources of sound, namely: first, the direct and, second, the generally reflected sound. For rooms that do not exhibit abnormal acoustical characteristics it may be assumed that the ratio of the reflected to the direct sound represents the effective reverberation of the collected sound.

Consider a sound collecting system, Fig. 12.14, the efficiency of reception of which may be characterized as a function of the direction with respect to some reference axis of the system. (The nondirectional collecting sys-

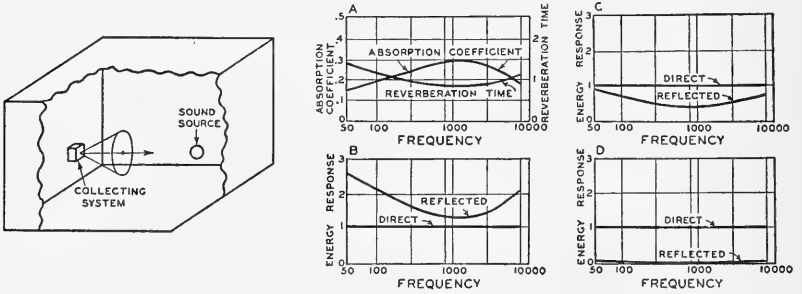

FIG. 12.14. Sound collecting system in a studio. Graph *A* shows the reverberation time and the absorption coefficient of the boundaries of a typical studio. Graphs *B*, *C* and *D* show the energy response for the direct and reflected sounds for various microphones as follows: *B*. Nondirectional microphone. *C*. Bidirectional velocity or unidirectional microphone. *D*. Ultradirectional microphone.

tem is a special case of the directional system in which the efficiency of reception is the same in all directions.) The output of the microphone may be expressed as

$$e = \mathcal{Q}pf_1(\psi) \tag{12.14}$$

- where  $e$  = voltage output of the microphone, in volts,
- $p$  = sound pressure, in dynes per square centimeter,
- $\mathcal{Q}$  = sensitivity constant of the microphone, and
- $\psi$  = angle between incident pencil of sound and the reference axis of the microphone.

If the distance, in centimeters, between the source of the sound and the collecting system is  $D$ , the energy density at the microphone due to the direct sound is

$$E_D = \frac{E_0}{D^2 4\pi c} \tag{12.15}$$

where  $E_0$  = power output of the sound source, in ergs per second, and  
 $c$  = velocity of sound, in centimeters.

To simplify the discussion, assume that the effective response angle of the microphone is the solid angle  $\Omega$  radians. The direction and phase of the reflected sound are assumed to be random. Therefore, the reflected sounds available for actuating the directional microphone are the pencils of sound within the angle  $\Omega$ . The response of the directional microphone to generally reflected sound will be  $\Omega/4\pi$ , that of a nondirectional microphone. The generally reflected sound to which the directional microphone is responsive is, therefore, given by

$$E_R = \frac{4E_0\Omega}{caS4\pi} [1 - \epsilon^{(cS \lceil \log_{\epsilon} (1-a) \rceil t)/4V}] (1 - a) \quad 12.16$$

where  $a$  = absorption per unit area, absorption coefficient,  
 $S$  = area of absorbing material, in square centimeters,  
 $V$  = volume of room, in cubic centimeters, and  
 $t$  = time, in seconds.

The ratio of the generally reflected sound to the direct sound is a measure of the recorded reverberation.

$$\frac{E_R}{E_D} = \frac{4D^2\Omega [1 - \epsilon^{(cS \lceil \log_{\epsilon} (1-a) \rceil t)/4V}] (1 - a)}{aS} \quad 12.17$$

If the sound continues until the conditions are steady, equation 12.17 becomes

$$\frac{E_R}{E_D} = \frac{4D^2}{aS} \Omega (1 - a) \quad 12.18$$

From equations 12.17 and 12.18, it will be seen that the received reverberation can be reduced by decreasing the distance  $D$ , by increasing the absorption  $aS$ , or by decreasing  $\Omega$ .

For a given room employing a directional microphone, the receiving distance can be increased  $\sqrt{4\pi/\Omega}$  times that in the nondirectional system with the same collected reverberation in both cases.

The absorption characteristic of a studio is shown in Fig. 12.14. The direct sound picked up by a nondirectional microphone and two directional microphones is the same because the distance between the sound source and the microphones is assumed to be the same for all three cases (Figs. 12.14*B*, 12.14*C* and 12.14*D*). The generally reflected sound picked up by a nondirectional microphone is shown in Fig. 12.14*B*. The generally

reflected sound picked up by a velocity or unidirectional microphone in which  $\Omega = 4\pi/3$  is shown in Fig. 12.14C. The generally reflected sound picked up by an ultradirectional microphone in which  $\Omega = \pi/10$  is shown in Fig. 12.14D. The effectiveness of a directional sound collecting system in overcoming reverberation and undesirable sounds is graphically depicted in Fig. 12.14.

Directional microphones, in addition to discriminating against noise and generally reflected sounds, have been found to be extremely useful in arranging actors in dialogue and for adjusting the relative loudness of the instruments of an orchestra.

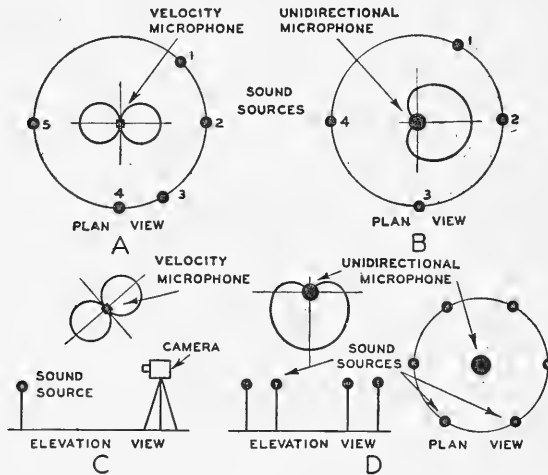

FIG. 12.15. Examples illustrating the use of directional microphones.

A plan view<sup>26</sup> of a velocity microphone and a number of sound sources is shown in Fig. 12.15A. Suppose that sources 2 and 5 represent two actors who are carrying on a dialogue. In view of the fact that this microphone receives with the same efficiency in two directions, it is possible to have the actors face each other, which is an advantage from a dramatic standpoint. Suppose that the sources of sound 1, 2, 3 and 5 represent the instruments of an orchestra. All the sources are located at the same distance. This means that 1 will produce 0.7 times the voltage output produced by 2 for the same loudness. In the same way 3 will be 0.5 of 2. Source 4 is considered as objectionable and is placed in the zero reception

<sup>26</sup> Olson, H. F., *Proc. Inst. Rad. Eng.*, Vol. 21, No. 5, p. 655, 1933.

zone. With this microphone the relative loudness of these sources can be adjusted by the angular position relative to the microphone axis as well as the distance. Obviously, this is a great advantage in balancing the instruments of an orchestra. In the case of a nondirectional microphone, the relative loudness can only be adjusted by the distance.

The same procedure<sup>27</sup> for balancing the instruments of an orchestra may be used in connection with a unidirectional microphone (Fig. 12.15*B*). The unidirectional microphone is particularly useful when all the instruments are grouped in front of the microphone and the objectionable sounds originate behind the microphone.

The directional characteristics of the velocity microphone are useful in overcoming objectionable noises.<sup>28</sup> It is possible to orient the microphone so that the objectionable noise lies in the plane of zero response of the microphone as shown in Fig. 12.15*C*.

In certain types of recording<sup>29</sup> it is desirable to place the microphone at the center of action directed upwards and collect sounds over an angle of 360° with respect to the microphone. (Figure 12.15*D* illustrates the use of a unidirectional microphone for this application.)

Other examples of the use of directional microphones are shown in Fig. 12.5.

B. *Broadcasting Studios.* — In the early days of broadcasting it was customary to make the reverberation time of the studios as low as possible. This imposed quite a strain upon the orchestra and singers to keep in tune. The almost universal use of directional microphones during the past few years has eliminated the necessity of extremely dead studios. As a result, the quality and artistic effects of the collected sound are materially enhanced.

The studios in a large broadcasting station should be graduated in size and in corresponding acoustical condition to accommodate anticipated loading to the best advantage. The control booths should be provided with sound proof windows located so that the studio engineer has an unobstructed view of the studio.

The studios should be insulated against all types of extraneous noises. Cinder composition has been found to give very good insulation. Resilient mounting of the walls, floor and ceiling reduces mechanical transmission.

Air borne noises carried in the air conditioning ducts may be suppressed by lining the ducts with felt, rock wool, etc., to obtain suitable attenuation.

<sup>27</sup> Olson, H. F., *Four. Soc. Mot. Pic. Eng.*, Vol. 27, No. 3, p. 284, 1936.

<sup>28</sup> Olson, H. F., *Four. Soc. Mot. Pic. Eng.*, Vol. 16, No. 6, p. 695, 1931.

<sup>29</sup> Olson, H. F., *Four. Soc. Mot. Pic. Eng.*, Vol. 27, No. 3, p. 284, 1936.

Mechanical transmission of sound by the ducts may be reduced by isolating the sections of the duct.

In the last few years, the live-end-dead-end principle has been modified and uniform absorption throughout the studio is obtained by uniform distribution of the absorbing material. Serrated and "V" walls have been used to break up discrete reflections. The use of treatments with complementary absorption characteristics to obtain the proper absorption is

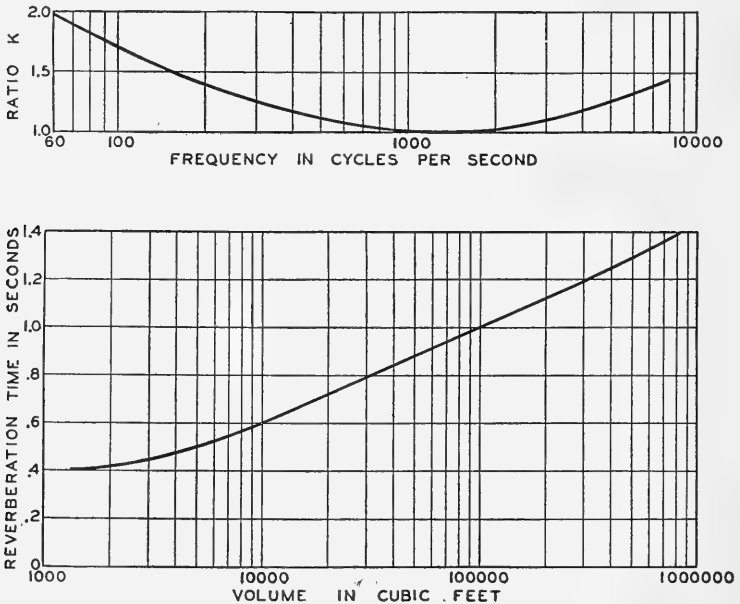

FIG. 12.16. Lower graph shows the reverberation time for a recording or broadcasting studio as a function of the volume for 1000 cycles. Upper graph shows the relation between the reverberation time and the frequency, that is, the reverberation time at other frequencies is obtained by multiplying by  $K$ . (After Morris and Nixon.)

usually preferable because of the latitude afforded in the decorative treatment of the studio.

#### *C. Reverberation Time of a Broadcasting, Recording and Scoring Studio.*

— The reverberation time of a studio is another important factor. The reverberation time<sup>30</sup> as a function of the volume of the studio for broadcasting and phonograph recording is shown in Fig. 12.16.

In the case of sound motion picture recording and television broadcasts the setting is usually a room within a room. The sound stage is usually

<sup>30</sup> Morris and Nixon, *Jour. Acous. Soc. Amer.*, Vol. 8, No. 2, p. 81, 1936.



designed to have a very low reverberation time to prevent echoes and reduce the effect of extraneous noise generated in the studio. In the case of sets consisting of small rooms the acoustics of the set masks the acoustics of the sound stage. In the early days of sound motion picture recording it was customary to make the sets of acoustic materials having good transmission at the low frequencies and high absorption at the high frequencies. In this way it was possible to keep the reverberation time of the set very low. With the advent of directional microphones it has been possible to use conventional materials for the construction of sets.

D. *Synthetic Reverberation.* — The reverberation time of studios may be changed and controlled within certain limits by means for varying the absorption. The amount of control that may be obtained by varying the amount of absorption by means of hard panels which cover the absorbing

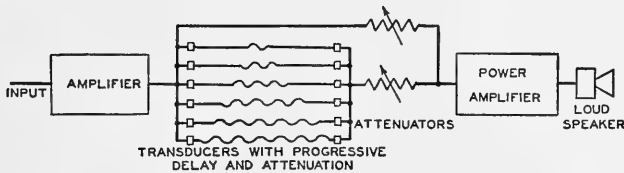

FIG. 12.17. Schematic arrangement of a system for introducing synthetic reverberation in reproduced sound.

material or other similar systems is limited. Furthermore, the reproducing conditions may also require additional reverberation. Where the reverberation time of reproduced sound is far below the optimum value, the reproduction may be enhanced by artificially adding reverberation. Reverberation in a room consists of the multiple reflection of a large number of pencils of sound. Each pencil of sound suffers a decrease in intensity with each reflection. These conditions can be simulated by the system shown in Fig. 12.17. The amplified sound is passed through a number of transducers with progressive delay and progressive attenuation. These transducers may be a series of pipes with a loud speaker at one end and a microphone at the other. Or, these transducers may be a series of pickups on a phonograph record or on a magnetic tape.<sup>31</sup> The amount of reverberation may be controlled by varying the direct and reverberant attenuation.

**12.4. Complete Reproducing Systems.** — A. *Telephone.* — The telephone is a sound reproducing system consisting of a carbon microphone (sometimes termed the transmitter), a telephone receiver, and a battery.

<sup>31</sup> Wolff, S. K., *Jour. Soc. Mot. Pic. Eng.*, Vol. 32, No. 4, p. 390, 1939.

The action of the carbon microphone has been described in Sec. 9.2*A*. The action of the telephone receiver has been described in Sec. 10.2. A simple telephone circuit employing a carbon microphone, a telephone receiver and a battery is shown in Fig. 10.11*A*. Employing these three elements and a transformer there are large numbers of possible circuits. In local transmission the electrical output of the microphone is sufficient for the telephone receiver to generate sound of ample loudness for intelligent transmission of speech. In long distance telephony, vacuum tube repeaters are used at regular intervals to restore the level of transmission to normal. The electroacoustic transducers of the telephone, namely: the microphone and telephone receiver, have been described in this book. The consideration of circuits, repeaters, automatic exchanges, etc., are outside the scope of acoustics and the reader is referred to books<sup>31*A*</sup> on these subjects.

**B. Binaural Reproduction.**—An ideal binaural sound reproducing system<sup>32</sup> is shown schematically in Fig. 12.18 which indicates that the desired objective is obtained by effectively transferring the auditor to the point of scenic action through the intermediary of a double recording and reproducing channel. Two microphones  $M_R$  and  $M_L$  simulate the ears of a dummy, each receiving the component of the original sound that would normally be received were the dummy a human being. Each component is reproduced through a separate audio channel, each channel terminating in a high quality telephone receiver. Each of the receivers is placed on the proper ear by the auditor and the sound produced in each of his ears will be identical to what would have been produced at the original set had he been there at the time.

FIG. 12.18. Schematic arrangement of the apparatus for a binaural reproducing system.

The advantages of this system are quite obvious; the binaural effect is practically perfect, and the reverberation characteristic of the set (which should be designed to conform to the scene) is transferred unadulterated to the listener.

<sup>31*A*</sup> Johnson, "Transmission Circuits for Telephonic Communication," D. Van Nostrand Co., New York.

<sup>32</sup> Olson and Massa, *Four. Soc. Mot. Pic. Eng.*, Vol. 23, No. 2, p. 63, 1934.

There are two serious disadvantages to this ideal system in addition to the requirement for a double channel. In the first place, a set of ear phones which must be worn throughout the performance and would not be tolerated by most persons, is required for each member of the audience. Second, in sound motion pictures, each listener should be in the same position relative to the screen as the dummy was relative to the original set. Such a condition is obviously impossible of realization and, consequently, those members of the audience who are somewhat removed from the screen will recognize a binaural effect not in accord with their distances from the scene. It appears, therefore, that the practical limitations of the ideal system render it undesirable for commercial application.

C. *Auditory Perspective Reproduction*<sup>33</sup>. — In the binaural reproducing system the ears of the auditor are effectively transferred to the original scene of action. A system for effectively transferring the original sources of sound from the studio to the theatre stage is shown schematically in Fig. 12.19. The sound is picked up by three microphones and amplified in separate channels, each channel feeding a separate loud speaker. The three loud speakers are arranged on the stage in the same positions as the microphones on the pickup stage. One of the principal objections to the system is the number of channels required. In the case of sound motion picture reproduction three separate sound tracks would be required. Radio reproduction would require three separate transmitters and channels. Some laboratory tests have been made in which two channels are used instead of three. This arrangement is a distinct improvement over a single channel system and appears to have commercial possibilities in both sound motion picture<sup>34</sup> and radio reproduction.

In addition to the objections that arise from the need of several channels,

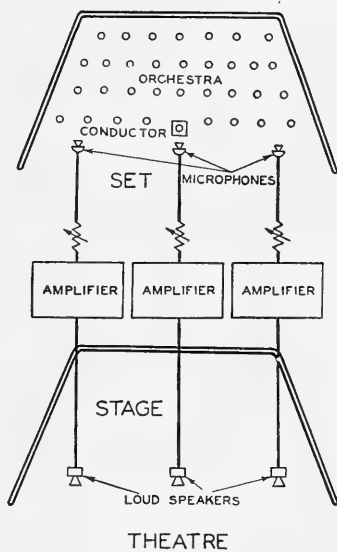

FIG. 12.19. Schematic arrangement of the apparatus for the reproduction of orchestral music in auditory perspective.

<sup>33</sup> Fletcher, H., *Jour. Soc. Mot. Pic. Eng.*, Vol. 22, No. 5, p. 314, 1934.

<sup>34</sup> Maxfield, Colledge and Friebus, *Jour. Soc. Mot. Pic. Eng.*, Vol. 30, No. 6, p. 666, 1938.

two other conditions tend to operate against the ideality of the system. The first arises from the fact that the acoustical characteristics of the theatre or auditorium are superimposed upon that of the set. Another objection arises from the necessity of requiring that the sound sources be spread far apart for the best effect. That means that the picture that is being reproduced should be spread out to cover the same distance occupied by the sound source; otherwise, the sound will appear to come "off stage" instead of from the picture. In the case of radio reproduction it may be impossible to spread the loud speakers sufficiently to obtain good illustration of perspective.

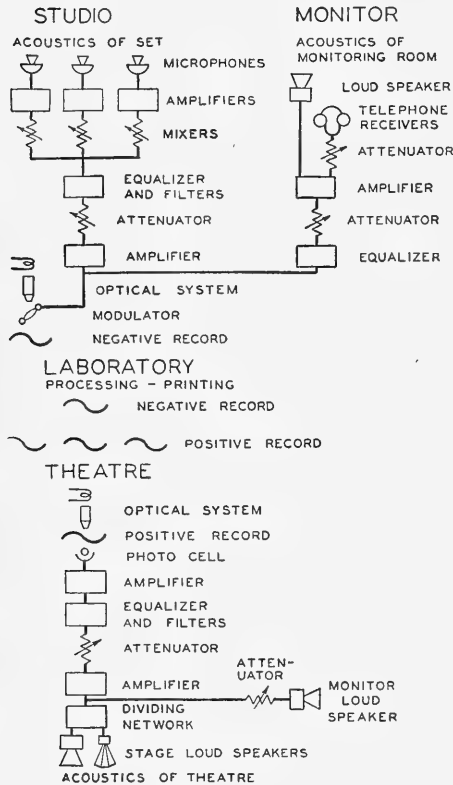

FIG. 12.20. Complete sound motion picture recording, processing and reproducing system.

D. *Sound Motion Picture Reproducing System.*—A complete sound motion picture recording and reproducing system is shown in Fig. 12.20. The first element is the acoustics of the set. The factors which influence the collection of sound have been discussed in Sec. 12.3. The output of the microphones is amplified and fed to attenuators termed mixers. If more than one microphone is used as, for example, a soloist accompanying an orchestra, one microphone for the singer and one for the orchestra, the output of the two may be adjusted for the proper balance. A low pass filter is usually used to reduce ground noise above the upper limits of reproduction. A high pass filter is used on speech with the lower limit placed below the speech range. This latter expediency reduces low frequency noises without impairing the speech quality. An equalizer is used to accentuate the high frequencies to compensate for the film transfer loss

reproduction. A high pass filter is used on speech with the lower limit placed below the speech range. This latter expediency reduces low frequency noises without impairing the speech quality. An equalizer is used to accentuate the high frequencies to compensate for the film transfer loss

at the high frequencies. The following attenuator controls the overall volume. The output of the amplifier feeds the light modulator and the monitoring system. By means of the optical system and light modulator the electrical variations are recorded on the film into the corresponding variations in density (termed variable density recording) or in area (termed variable area recording). The monitoring system is also connected to the output of the recording amplifier. An equalizer is used to adjust the frequency characteristic to simulate that of the ultimate reproduction. If the monitoring is carried out in a room a loud speaker is used. When the monitoring and mixing is carried out on the set, head phones are used for monitoring.

The negative record is sent to the laboratory and developed. Then positive records of both the sound and the picture are printed from the sound and picture negatives. These positive records are then developed and are ready for reproduction in a theatre.

The variable density or variable area record is reproduced in the theatre by pulling it past a slit illuminated by a light and a suitable optical system. The resultant variations in light, due to the variable density or variable area on the film, fall upon the photoelectric cell and are converted into the corresponding electrical variations. These are then amplified and fed to equalizers and filters. A low pass filter is used to cut out the ground noise due to film above the upper limit of reproduction. An equalizer is used to adjust the frequency characteristic to that suitable for the best reproduction in the theatre. The attenuator is used for adjusting the level of reproduction. The output of the power amplifier feeds the stage loud speakers and monitoring loud speaker. The monitoring loud speakers and the attenuator are located in the projection booth. As a matter of fact, the entire system, save for the stage loud speakers, is located in the projection booth. A dividing network and a two channel loud speaker system are shown in Fig. 12.20. Of course, any type of suitable loud speaker described in Chapter VIII may be used. The action of a sound motion picture reproducer in a theatre has been discussed in Sec. 12.2*B* and will not be repeated here.

In some cases, the original record is re-recorded and additional sound is added. For example, in certain dialogue sequences it may be desirable to add incidental music to heighten the artistic effects. In this case the dialogue is recorded first. Then this record is reproduced on a system similar to the theatre reproducer. The orchestra is picked up on the standard recording system. The two outputs are mixed and fed to the modulator and a new negative record is made.

E. *Radio Sound Reproducing System.* — A complete radio broadcasting and receiving system is shown in Fig. 12.21. The factors which influence the collection of sound in a broadcasting studio have been discussed in Sec. 12.3. The mixers and attenuators are used in the same manner as in the case of

the sound motion picture system. The monitoring system and mixer console are located in the control room. A sound-proof glass wall partition which separates the studio and control room gives the engineer full view of the action in the studio. The output of the studio amplifier feeds the isolating amplifiers and the monitoring system. Isolating amplifiers feed the wire lines to the various transmitters. In the case of the local transmitter, repeaters are not needed and the output of the isolating amplifier is fed directly to the equalizer and limiting amplifier. The equalizer compensates for the frequency discrimination in the line. The limiting amplifier is followed by an attenuator for controlling the input to the transmitter amplifier. The amplifier is followed by the modulator and radio frequency oscillator. The output of the oscillator feeds the antenna. The monitoring system at the transmitter consists of a detector coupled to the output of the transmitter and followed by an attenuator, amplifier and loud speaker.

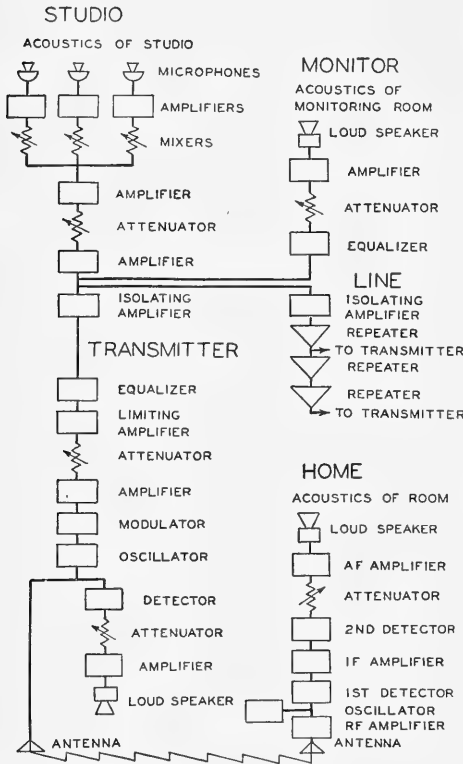

FIG. 12.21. Complete radio broadcasting and receiving system.

amplifier is followed by the modulator and radio frequency oscillator. The output of the oscillator feeds the antenna. The monitoring system at the transmitter consists of a detector coupled to the output of the transmitter and followed by an attenuator, amplifier and loud speaker.

A very small portion of the radio frequency energy radiated by the transmitter antenna is picked up by the receiving antenna. A typical superheterodyne receiver is shown in Fig. 12.21. The output of the antenna is amplified in the radio frequency stages and combined with an intermediate

frequency oscillator and fed to the first detector. The output of the first detector is amplified by the intermediate frequency amplifier and then fed to the second detector. The audio frequency output of the detector is followed by an attenuator and power amplifier which drives the loud speaker. The action of a radio reproducer in a living room has been discussed in Sec. 12.2J.

F. *Phonograph Reproducing System.* — A complete phonograph recording and reproducing system is shown in Fig. 12.22. The general studio equipment is quite similar to that of a broadcasting studio except for the equalizers and filters. An equalizer is used to attenuate the output fed to the cutter below 600 cycles to yield approximately uniform amplitude below 600 cycles. The high frequency response is accentuated in recording so that a corresponding attenuation in the high frequency response in reproduction will effect a reduction in ground noise without frequency discrimination in the reproduced sound. The cutter actuated by the amplifier cuts a spiral wavy path in the revolving record corresponding to the undulations in the original sound wave striking the microphone.

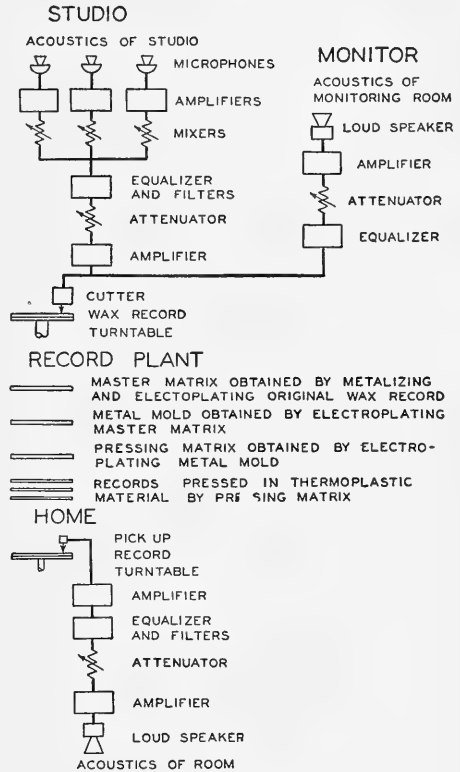

FIG. 12.22. Complete phonograph recording, record pressing and reproducing system.

In the record plant the original wax is metalized by sputtering with gold and electroplating with copper. The resulting plating is separated from the wax and backed by solid metal plate and is termed the master matrix. The master matrix is electroplated with copper. This plating is separated from the master matrix and backed by a solid plate and is termed the metal mold. The metal mold in turn is electroplated with copper. This plating is separated from the metal mold and backed by a solid metal plate and is termed the pressing matrix. By means of a hydraulic press the final records

are pressed in thermoplastic material by the pressing matrix. The spiral wavy path in the final record corresponds to that in the original soft wax record.

In reproducing, the record is turned at a constant speed by the turntable. The stylus or needle follows the wavy spiral groove and generates voltage corresponding to the undulations in the record. The output of the pickup is equalized to compensate for the equalization in the original recording. A low pass filter is used to attenuate the response above the upper frequency limit of reproduction and thereby effects a reduction in the ground noise. An attenuator controls the volume of reproduction. The attenuator is followed by the amplifier which drives the loud speaker. The action of a reproducer in a living room has been considered in Sec. 12.2*J*.



## CHAPTER XIII

### SPEECH, MUSIC AND HEARING

**13.1. Introduction.** — The major portion of this book has been concerned with the theory, design and testing of acoustical apparatus for the reproduction of sound. The ultimate significant destination of all reproduced sound is the human ear. The physiological and psychological effects of the reproduced sound are the most important factors in any sound reproducing system. Sounds heard may be classified as speech, music or noise. An enormous amount of valuable data relating to speech and hearing have been collected. This data is extremely useful in the development and design of sound reproducing equipment. It is beyond the scope of this book to present all the pertinent data of physiological and psychological acoustics. For information beyond that given in this chapter the reader may consult the references. It is the purpose of this chapter to show the principal characteristics of speech, music and hearing and the relation between these characteristics and the objective characteristics discussed in the preceding chapters.

**13.2. Hearing Mechanism**<sup>14</sup>. — The hearing mechanism may be divided into three parts: the outer ear, the middle ear, and the inner ear. The outer ear consists of the external ear or pinna and the ear canal which is terminated in the ear drum or tympanic membrane. Behind the ear drum is the middle ear, a small cavity in which three small bones or ossicles form the elements of a mechanical transformer for transmitting vibrations mechanically from the ear drum to an aperture termed the oval window in the inner ear. The casing of the inner ear (the cochlea) is a bony structure of a spiral form (two and three quarter turns). The cochlea is divided along its length into three parts by the basilar membrane and Riessner's membrane. These three parallel canals are wound into the spiral. On one side of the basilar membrane is the organ of Corti, which contains the nerve terminals in the form of small hairs extending into the canal of the cochlea. These nerve endings are stimulated by the vibrations in the cochlea.

---

<sup>14</sup> Fletcher, "Speech and Hearing," D. Van Nostrand Co., New York.

When a sound wave impinges upon the ear, it enters the ear canal and causes the ear drum to vibrate. The vibration of the ear drum is communicated by the lever action of the middle ear to the inner ear or cochlea. In this mechanical transformer the amplitude reduction is one-sixtieth and the force variation is increased by sixty times. From various experiments the highest frequencies are associated with the portion of the basilar membrane near the oval window. The lowest frequency is associated with the extreme end removed from the oval window. For example, in the case of 1000 cycles the nerves which are stimulated are those near the midpoint of the basilar membrane.

**13.3. Speech Mechanism**<sup>1A</sup>. — The energy required for speech is provided by the lungs in the form of an air stream. In the larynx a pair of muscular strips, termed the vocal chords, form a slit through which the air passes. When speaking they are tensed by muscular contraction and the passage of air causes them to vibrate. The air then issues in a series of puffs of a frequency controlled by the natural frequency of the vocal chords. The sound thus produced is not a pure tone but very complex. The overtone structure is somewhat under control of the muscular system and the air pressure.

The sound from the larynx passes through the cavity called the pharynx, then through an aperture at the back of the mouth, then through the mouth cavity and out of the aperture formed by the lips. The two cavities are acoustic capacitances and the apertures are two inertances. The nasal cavity and nose aperture form a shunt to the mouth cavity. The complex tone produced by the vocal chords is modified by the resonances of the capacitances and inertances. The size of the cavities and apertures is controllable and hence the tone structure of the sound which issues from the mouth varies as these constants are changed.

The vowel sounds are produced by the above mechanism. The consonants are produced by the air rushing through the various outlets, usually of small dimensions. The consonants are of course influenced by the resonances of the cavities and apertures.

*A. Artificial Larynx*<sup>1B</sup>. — In cases where the larynx has been removed by an operation, speech is possible by the use of an artificial larynx. The artificial larynx consists of a reed actuated by the air from an opening in the front of the throat through which breathing takes place. The complex tone generated by the reed is conducted by a tube into the mouth cavity. The quality of the sounds is modified by the resonances in the

<sup>1A</sup> Fletcher, "Speech and Hearing," D. Van Nostrand Co., New York.

<sup>1B</sup> Riesz, R. R., *Four. Acous. Soc. Amer.*, Vol. I, No. 2, p. 273, 1930.

cavities of the head. In case the air from the lungs cannot be used for blowing the reed, a bellows may be employed.

B. *Vocoder*<sup>1C</sup>. — The term vocoder is applied to a system for remaking speech automatically from a buzzer-like tone and a hiss-like noise corresponding to the vocal cord tone and the breath tone of normal speech. Control of pitch and frequency spectrum obtained from the talker's speech are applied to make synthetic speech copy the original speech sufficiently for good intelligibility, although the currents used in such controls contain only low syllabic frequencies of the order of 10 cycles per second as contrasted with frequencies of 100 to 3000 cycles in the remade speech.

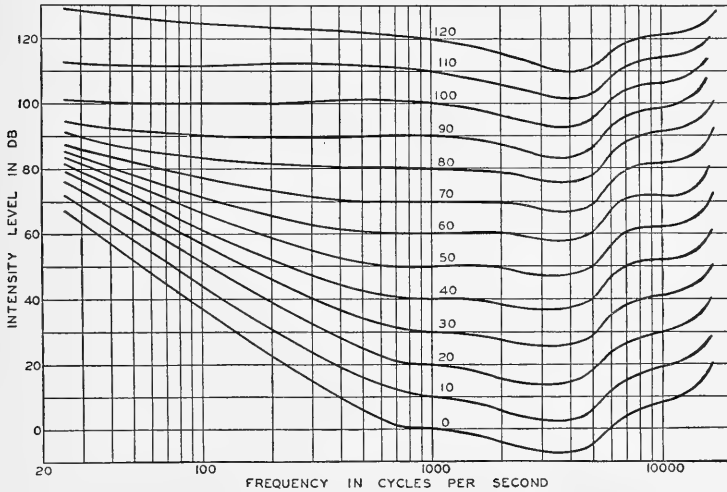

FIG. 13.1. Contour lines of equal loudness for normal ears. Numbers on curves indicate loudness level. 0 db =  $10^{-16}$  watts per square centimeter. 0 db = 0.000204 dyne per square centimeter. (After Fletcher and Munson.)

**13.4. Response Frequency Characteristics of Ears.** — The loudness of a pure tone depends upon the frequency and intensity. See Sec. 13.5 for the definition of loudness. This relation is revealed in the Fletcher-Munson<sup>1D</sup> equal loudness level curves shown in Fig. 13.1. The 1000 cycle tone is the reference tone in these determinations. The loudness level of other tones is the intensity level of the equally loud 1000 cycle tone. These characteristics show that the ear is most sensitive in the region between

<sup>1C</sup> Dudley, *Four. Acous. Soc. Amer.*, Vol. XI, No. 2, p. 169, 1939.

<sup>1D</sup> Fletcher and Munson, *Four. Acous. Soc. Amer.*, Vol. 5, No. 2, p. 82, 1933.

3000 and 4000 cycles. The sensitivity of the ear decreases above and below this frequency. The response frequency characteristics of ears are useful and of fundamental importance in the design of reproducing systems. For example, the threshold of hearing at 60 cycles is 48 db higher than that at 1000 cycles.

In general, sound is reproduced at a level lower than that of the original sound. To compensate for the difference in frequency balance, due to the lower reproduction level, an acoustically compensated volume control is used to increase the relative low frequency response as the level is reduced. See Sec. 12.2*J*.

These characteristics must be considered in the measurement of noise. The response frequency characteristic of the noise meter is adjusted to correspond to the ear characteristics. See Sec. 11.7.

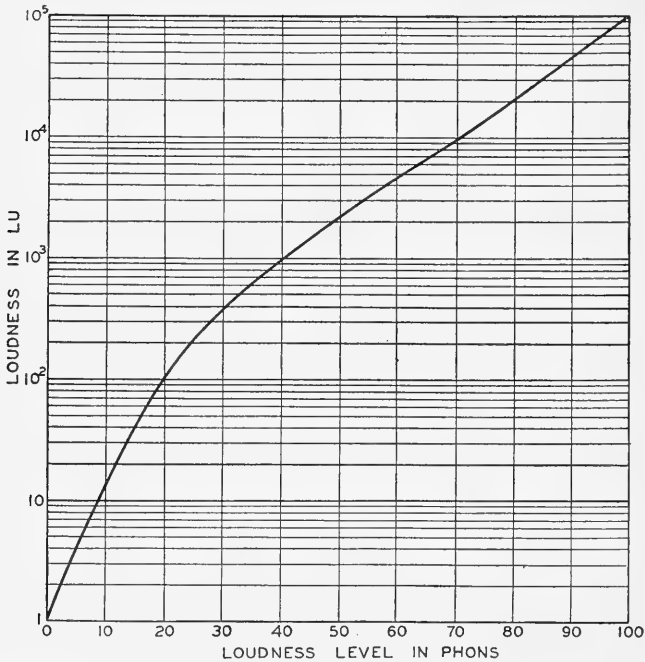

FIG. 13.2. Loudness versus loudness level. (After Fletcher and Munson.)

**13.5. Loudness of a Sound.** — Loudness of a sound is the magnitude of the auditory sensation produced by the sound. The units on the scale of loudness should agree with common experience in the estimates made upon sensation magnitude. A true loudness scale must be constructed so

that when the units are doubled the sensation will be doubled and when the scale is trebled the sensation will be trebled, etc. Units on the scale are called loudness units, abbreviated L. U. The loudness level of the reference tone, expressed in phons, is the intensity level of the reference tone (1000 cycles) in decibels. The loudness level of any other sound is determined by adjusting the reference tone until it sounds equally loud.

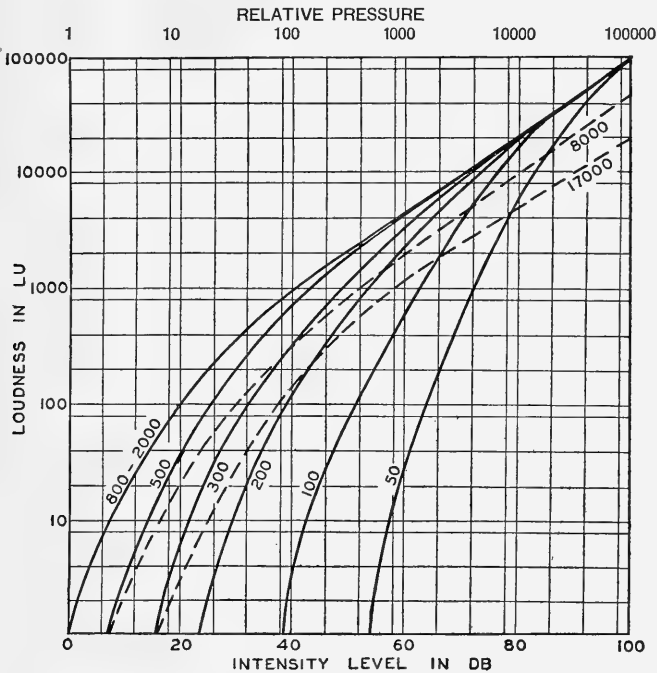

FIG. 13.3. The relation between the intensity level and the loudness of pure tones of the frequencies indicated. 0 db = 0.000204 dyne per square centimeter. (After Fletcher and Munson.)

The loudness level of the measured sound is the loudness level of the reference sound expressed in phons. A scale<sup>2</sup> showing the relation between loudness level, in phons, and the loudness, in loudness units, is shown in Fig. 13.2.

The loudness of pure tones of various frequencies is shown in Fig. 13.3. For tones between 800 and 2000 cycles the loudness is the same for the same pressure. The difference is small up to 8000 cycles. For higher frequencies than this the loudness decreases as the frequency increases. Further,

<sup>2</sup> Fletcher and Munson, *Four. Acous. Soc. Amer.*, Vol. 9, No. 1, p. 1, 1937.

it will be seen that for a 50 cycle tone the intensity required to reach the threshold of hearing is 250,000 times that required for a reference 1000 cycle tone.

**13.6. Change of Pitch with Loudness.** — Frequency of a sound wave is the number of cycles per second executed by the particles of the medium in which a sound is being propagated. Pitch is that subjective quality of a sound which determines its position in a musical scale. Pitch may be measured as the frequency of a pure tone having a specified sound pressure which seems to the average ear to occupy the same position in a musical

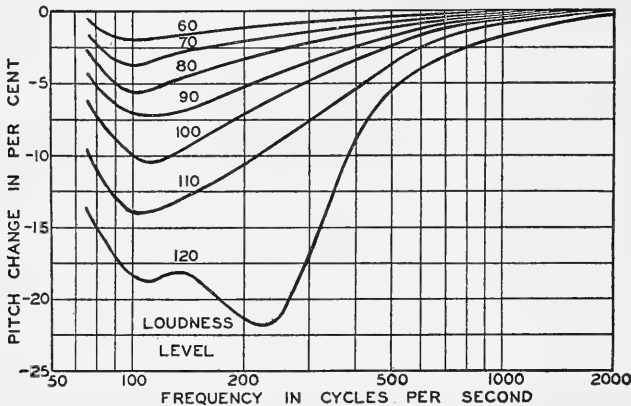

FIG. 13.4. Contours of constant loudness level. Curves show the amount by which the pitch of a pure tone of any frequency is shifted as the tone is raised in loudness level from 40 to the level of the contour. For example, a 100-cycle tone will be changed ten per cent downward in pitch if raised from a loudness level 40 to a loudness level 100, but a 500-cycle tone will be changed only two per cent for the same loudness level increase. (After Snow.)

scale. Thus it will be seen that there is definite distinction between frequency and pitch. For example, a tone of a fixed frequency of a few hundred cycles decreases in pitch as the intensity is increased. The change<sup>3</sup> in pitch with loudness is shown in Fig. 13.4.

**13.7. Masking**<sup>4,5</sup>. — The reduction of the ability of a listener to hear one sound in the presence of other sounds is known as masking. In testing the masking properties of a sound, pure tones are generally used as the masked sound. The number of decibels that the threshold level of a pure

<sup>3</sup> Snow, W. B., *Jour. Acous. Soc. Amer.*, Vol. 8, No. 1, p. 14, 1936.

<sup>4</sup> Wegel and Lane, *Phys. Rev.*, Vol. 23, No. 2, p. 266, 1924.

<sup>5</sup> Fletcher and Munson, *Jour. Acous. Soc. Amer.*, Vol. 9, No. 1, p. 1, 1937.

tone is shifted, due to the presence of noise, is called the masking in decibels at the frequency corresponding to that of the pure tone.

The masking effect of a pure tone, a narrow band of thermal noise and a wide band of thermal noise is shown in Fig. 13.5. The figures on each of the curves show the intensity level of the masking tone or noise. The ordinates, in each of the charts, show the decibels above the threshold that the various frequencies must be raised in order to be just heard in the

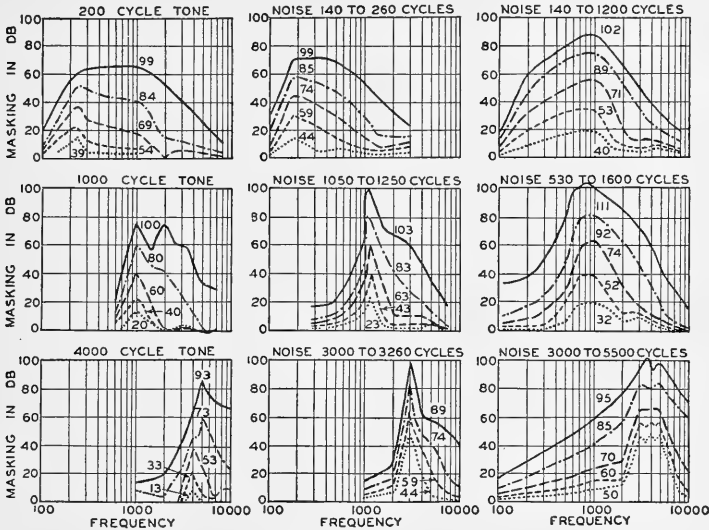

FIG. 13.5. Masking audiograms for single frequency tones, narrow bands of thermal noise and wide bands of thermal noise. The curves are labeled in db above zero loudness. (After Fletcher and Munson.)

presence of the particular masking tone or noise. For example, referring to the 4000 cycle tone having an intensity of 93 db, it is only necessary to raise a 2000 cycle tone 20 db to be heard. On the other hand, a 10,000 cycle tone must be raised 66 db to be heard.

**13.8. Nonlinearity of the Ear**<sup>6</sup>. — When a pure tone of a suitable intensity is impressed upon the ear a series of harmonics or overtones of the original frequency are heard. Furthermore, when two loud tones are sounded together, a group of tones is heard consisting of the sums and differences of the two primary tones and their harmonics. These phenomena show that the ear is a nonlinear system.

<sup>6</sup> Stevens and Davis, "Hearing," p. 184, John Wiley and Sons, New York.

The sensation levels of the fundamental at which the various harmonics first become detectable,<sup>7,8</sup> are shown in Fig. 13.6. The subjective effects of the harmonics generated in the ear are more pronounced at the lower frequencies. Furthermore, the harmonics appear at a lower level at the lower frequencies.

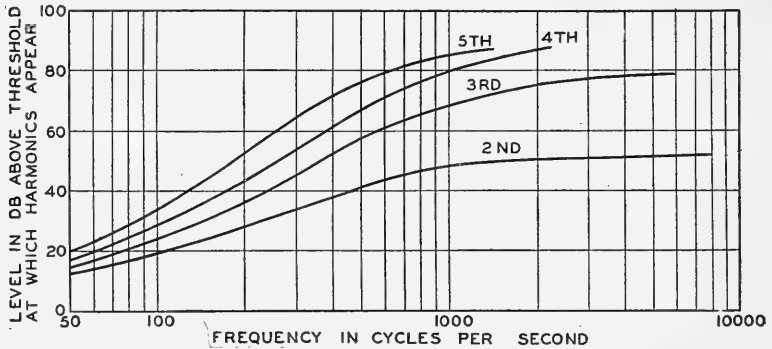

FIG. 13.6. The level above threshold at which harmonics are generated in the ear at various frequencies. (After Wegel and Lane.)

**13.9. Effect of Phase Relations Among the Harmonics**<sup>9,10,11</sup>. — The phase of a harmonic affects the threshold of perceptible distortion as well as the quality of a complex sound. This statement contradicts the so called Ohm's Auditory Law; that the ear tends to analyze the compounds of a complex sound regardless of the phase relations. There is a definite phase relation which will produce the greatest loudness and another which will produce the least loudness. For example, a harmonic in the actuating sound may re-enforce or cancel an aural harmonic.

**13.10. Modulation**<sup>12,13</sup>. — Amplitude, phase, or frequency modulation refers to a change in the amplitude, phase or frequency of a sound wave. Suppose that an oscillator is connected to a loud speaker, Fig. 11.6. If the volume control is varied, the result is amplitude modulation. If the fre-

<sup>7</sup> Wegel and Lane, *Phys. Rev.*, Vol. 23, No. 2, p. 266, 1924.

<sup>8</sup> Fletcher, "Speech and Hearing," D. Van Nostrand Co., New York.

<sup>9</sup> Chapin and Firestone, *Four. Acous. Soc. Amer.*, Vol. 5, No. 3, p. 173, 1934.

<sup>10</sup> Lewis and Larsen, *Nat. Acad. Sci.*, Vol. 23, p. 415, 1937.

<sup>11</sup> Stevens and Davis, "Hearing," p. 203, John Wiley and Sons, New York.

<sup>12</sup> Seashore, C. E., "Psychology of Music," p. 33, McGraw Hill Book Co., New York.

<sup>13</sup> Stevens and Davis, "Hearing," p. 225, John Wiley & Sons, New York.



quency control is varied, the result is frequency modulation. If the position of the loud speaker is varied with respect to the observation point, the result is phase modulation.

The vibrato is used as an artistic embellishment by singers. It is an example of frequency modulation. The average rate of the vibrato is seven cycles per second.

When two tones of nearly the same frequency are sounded together, they produce beats at a rate equal to the frequency difference between them. In the case of very slow beats the intensity seems to rise and fall continuously. Faster beats appear as intermittent impulses.

**13.11. Auditory Localization**<sup>14, 15, 16</sup>. — The human hearing mechanism can localize sounds with great accuracy. This property is due to two effects, namely: the difference in intensity and the difference in phase between the sound at the two ears. The difference in phase between the sounds at the two ears is due to the difference in time arrival at the two ears. The difference in intensity at the two ears is due to diffraction. The pressure at the two ears may be obtained from Fig. 1.5. by assuming the head to be a rigid sphere. This assumption has been verified experimentally.

The binaural phase effect is confined principally to the lower frequencies, namely: below 1000 cycles. The binaural phase effect has been utilized for the location of airplanes, submarines, etc.

If attachments can be made to the ears which will virtually separate them further (for example, spread the microphones on the dummy of Fig. 12.18), then a small rotation of the apparatus will mean a larger difference in phase at the receivers than at the unaided ear. Of course, there may be ambiguity as to whether the sound comes from in front or behind, but this does not vitiate the method.

The difference in intensity at the two ears due to diffraction is very small below 1000 cycles. However, at the higher frequencies the difference in intensity may be 20 to 30 db.

The human hearing mechanism is also a directional collecting system. Using the system of Fig. 12.18, the reverberation in a room appears to be normal. However, if only one microphone is used, the apparent reverberation will be increased. This indicates that the human hearing mechanism is very directional and discriminates against reverberation and other undesirable sounds. For this reason it has been found necessary to use

<sup>14</sup> Stewart, G. W., *Phys. Rev.*, Vol. 15, No. 5, p. 425, 1920.

<sup>15</sup> Stevens and Davis, "Hearing," p. 167, John Wiley & Sons, New York.

<sup>16</sup> Steinberg and Snow, *Bell Syst. Tech. Jour.*, Vol. 13, No. 2, p. 245, 1934.

either very small pickup distances or directional collecting systems in the monaural collection of sound.

**13.12. The Frequency and Volume Ranges of Speech and Music and the Effects of Frequency Distortion upon Reproduced Sound.** — The frequency range of the average normal ear is from 20 to 20,000 cycles. The frequency range of most reproducing channels such as the radio, the telephone, the phonograph and the sound motion picture is considerably less than that of the hearing range of the ear. It is interesting to note the effect of the frequency range upon the intelligibility of speech and the quality of music.

The frequency<sup>17</sup> and volume ranges of speech and orchestral music are shown in Fig. 13.7. The reproduction of speech with perfect fidelity

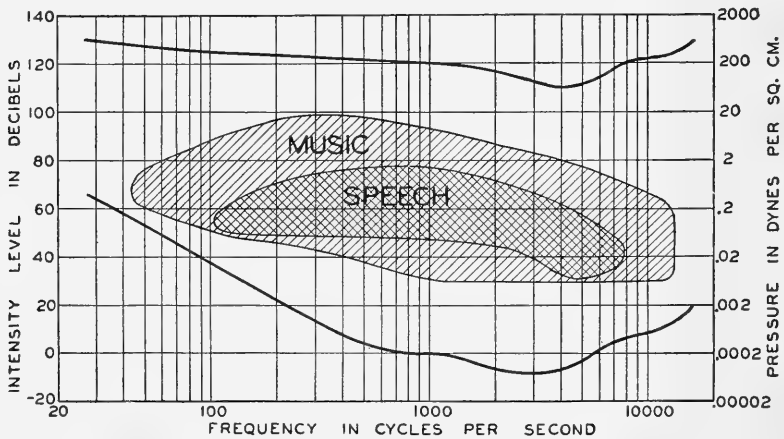

FIG. 13.7. Frequency and volume ranges of speech and music. (From *Bell Laboratories Record*, June, 1934.)

requires a frequency range of from 100 to 8000 cycles and a volume range of 40 db. The reproduction of orchestral music with perfect fidelity requires a frequency range of from 40 to 14,000 cycles and a volume range of 70 db.

The effect<sup>18</sup> of reducing the high and low frequency range upon speech articulation is shown in Fig. 13.8. It will be seen that a relatively high articulation can be obtained with a very narrow transmission band. However, the quality of the reproduced speech is very much impaired by transmission over a narrow frequency band. A limited range may be

<sup>17</sup> *Bell Laboratories Record*, Vol. 12, No. 6, p. 314, 1934.

<sup>18</sup> Fletcher, "Speech and Hearing," p. 280, D. Van Nostrand Co., New York.

actually superior to a wider band due to the introduction of additional noises and distortions in a wider band unless particular precautions are ob-

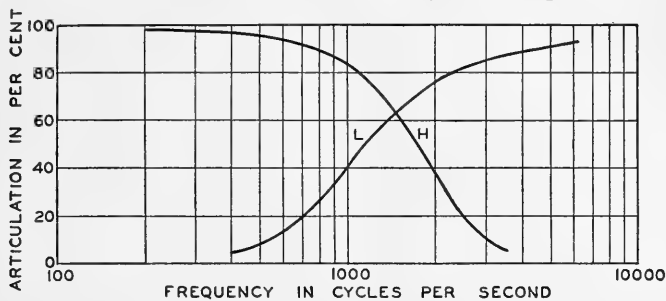

FIG. 13.8. The effect of the frequency range upon the articulation of speech. *H.* High pass filter — all frequencies below the frequency given by the abscissa removed. *L.* Low pass filter — all frequencies above the frequency given by the abscissa removed. (After Fletcher "Speech and Hearing," D. Van Nostrand Co.)

served. In the case of speeches, plays and songs, a limited frequency range impairs the quality and artistic value of the reproduced sound.

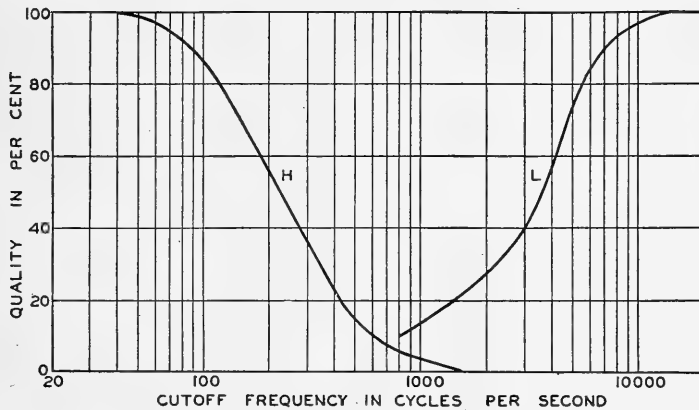

FIG. 13.9. The effect of the frequency range upon the quality of orchestra music. *H.* High pass filter — all frequencies below the frequency given by the abscissa removed. *L.* Low pass filter — all frequencies above the frequency given by the abscissa removed. (After Snow.)

The effect of the frequency range<sup>19</sup> upon the quality of reproduction of orchestral music is shown in Fig. 13.9. It will be seen that the frequency range required for no appreciable loss in quality is from 40 to

<sup>19</sup> Snow, W. B., *Jour. Acous. Soc. Amer.*, Vol. 3, No. 1, Part 1, p. 155.

14,000 cycles. A good radio transmitter and receiver in the broadcast band will cover a frequency range of from 40 to 8000 cycles and a volume range of 50 to 60 db. These frequency and volume ranges will cover the speech area of Fig. 13.7, but will not cover the orchestral music area. For the latter case some form of volume compression must be used.

**13.13. Absolute Amplitudes and Spectra of Speech, Musical Instruments and Orchestras**<sup>20, 21, 21A</sup>. — The average and peak outputs of speech and musical instruments are of importance in the design of all types of reproducing equipment. For example, the average power output involves such factors as the heating of the voice coil, the heating of audio power transformers, etc., while the peak power output fixes the overload point of the system.

The ratio of the average sound pressure per cycle to the average total pressure of the entire spectrum for speech, various musical instruments and orchestras is shown in Fig. 13.10. The ratio of the peak pressure to the average pressure of the entire spectrum for speech, various musical instruments and orchestras is shown in Fig. 13.11. The peak or total power output can be computed from the pressure and the distances following the procedure as outlined in Sec. 11.3D.

**13.14. Effect of Nonlinear Distortion upon the Quality of Reproduced Speech and Music**<sup>22, 23, 24</sup>. — In an ideal reproducing system the elements are invarient with respect to the time. However, in practical systems the elements are nonlinear. These elements introduce nonlinear distortion. Some idea of the effect of nonlinear distortion can be obtained from a study of the masking curves. From these data it will be seen that the higher order harmonics are noticeable at much lower levels than the lower order harmonics. Furthermore, as the high frequency range is increased the effect of the harmonics is more noticeable. In the complex waves of speech and music, sum and difference tones are also an important phase of the problem of nonlinear distortion.

Tests of music reproduction, on a system with uniform response from 45 to 8500 cycles at a peak level of 80 db, have indicated that 5 per cent second harmonic and 3 per cent third harmonic are noticeable on a direct comparison with a system having less than 1 per cent total distortion. In

<sup>20</sup> Sivian, Dunn and White, *Jour. Acous. Soc. Amer.*, Vol. 2, No. 3, p. 330, 1931.

<sup>21</sup> Sivian, L. J., *Jour. Acous. Soc. Amer.*, Vol. 1, No. 2, Part 2, p. 1, 1930.

<sup>21A</sup> Hathaway, J. L., *Electronics*, Vol. 12, No. 11, p. 29, 1939.

<sup>22</sup> Stevens and Davis, "Hearing," p. 200, John Wiley and Sons, New York.

<sup>23</sup> Olson and Massa, "Applied Acoustics," P. Blakiston's Son and Co., Philadelphia.

<sup>24</sup> Massa, F., *Proc. Inst. Rad. Eng.*, Vol. 19, No. 5, p. 682, 1933.

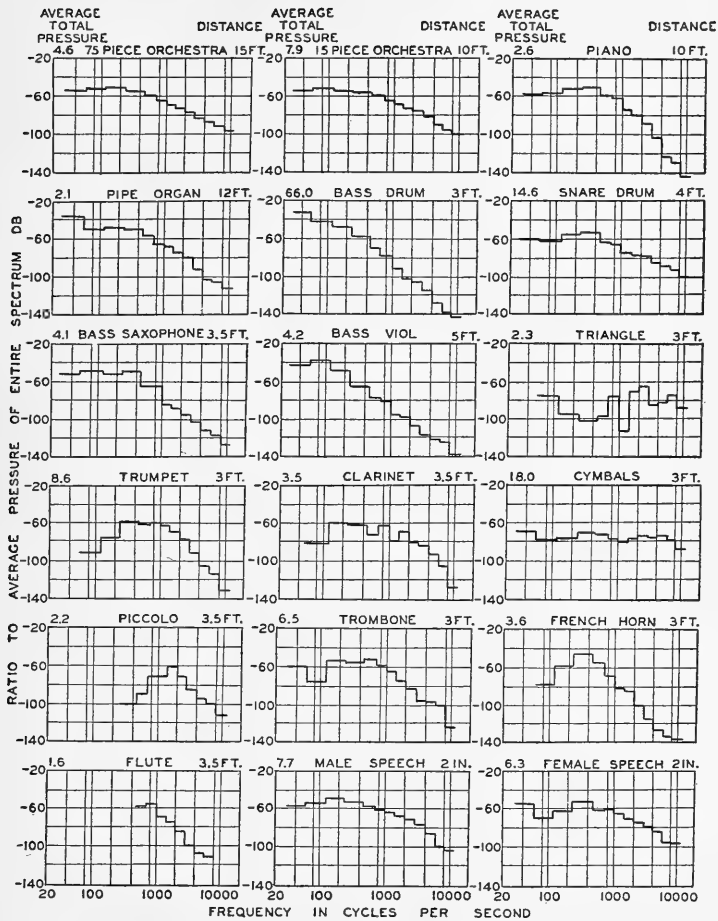

FIG. 13.10. Ratio of the average pressure per cycle to the average total pressure of the entire spectrum for speech, various musical instruments, and orchestras. The distance and average total pressure are shown above each graph. (After Sivian, Dunn and White.)

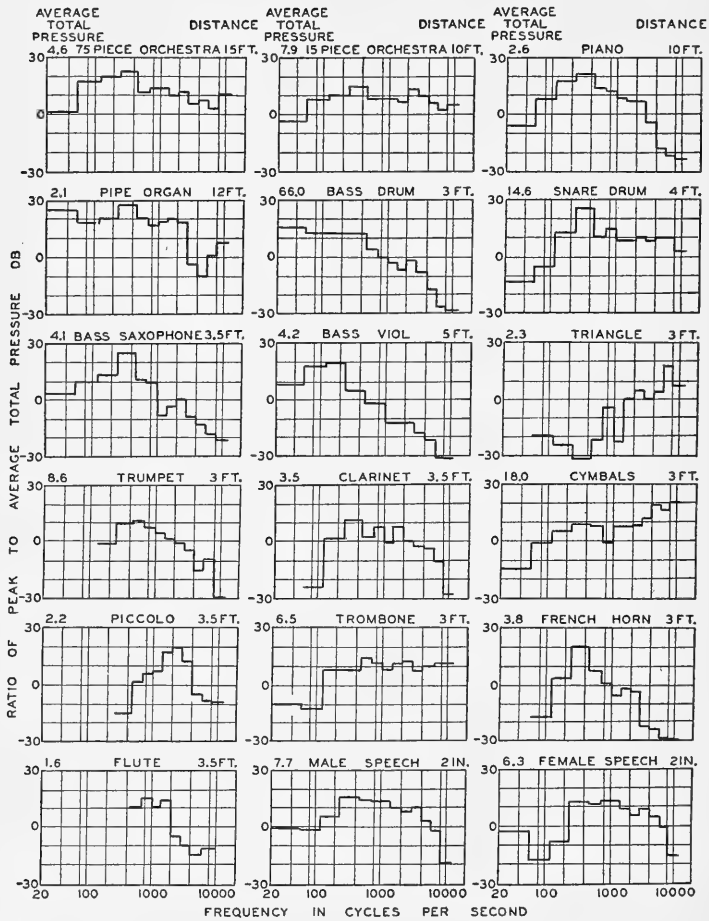

FIG. 13.11. Ratio of the peak pressure to the average total pressure of the entire spectrum for speech, various musical instruments, and orchestras. The distance and average total pressure are shown above each graph. (After Sivian, Dunn and White.)

the case of the higher harmonics introduced by Class B or pentode output systems, a fraction of a per cent is noticeable on direct comparison tests with systems in which these higher components are very low as, for example, Class A output systems.

**13.15. Combination Tones and Nonlinear Transducers.** — In most of the discussions in this book the elastic restoring force of the elements of a vibrating system have been considered to be proportional to the first power of the displacement. If a second power term is included the element is asymmetrical, the restoring force being different in magnitude for positive and negative displacements. According to most investigators the structure of the ear is of such an asymmetrical character.

Assume that the displacement of the nonlinear element may be expressed as follows

$$y = ap + bp^2 \quad 13.1$$

where  $p$  = the actuating force,

$a$  = a constant, and

$b$  = a constant.

Suppose two harmonic forces  $p_1 = p_0 \cos \omega_1 t$  and  $p_2 = p_0 \cos \omega_2 t$  are impressed upon the system. The total force on the nonlinear element is

$$p = p_1 + p_2 = p_0 \cos \omega_1 t + p_0 \cos \omega_2 t \quad 13.2$$

Substituting equation 13.2 in 13.1 the resulting equation may be put in the form

$$y = ap_0 \cos \omega_1 t + ap_0 \cos \omega_2 t + \frac{1}{2}bp_0^2 \cos 2\omega_1 t + \frac{1}{2}bp_0^2 \cos 2\omega_2 t \\ + bp_0^2 \cos (\omega_1 + \omega_2)t + bp_0^2 \cos (\omega_1 - \omega_2)t + bp_0^2 \quad 13.3$$

If the element under consideration is the ear it will be seen that six different frequencies will be heard as follows: the first primary frequency  $\omega_1/2\pi$ , the second primary frequency  $\omega_2/2\pi$ , the second harmonic of the first primary frequency  $\omega_1/\pi$ , the second harmonic of the second primary frequency  $\omega_2/\pi$ , the summation frequency  $(\omega_1 + \omega_2)/2\pi$ , the difference frequency  $(\omega_1 - \omega_2)/2\pi$ . The last term  $bp^2$  represents a steady force and produces no sound.

Combination or sum and difference tones may be produced in any nonlinear system as, for example, an intense sound in the air, in the throat of a horn, by overloaded vacuum tube amplifiers, by diaphragms and by suspension systems.

**13.16. Minimum Perceptible Differences.** — The minimum perceptible difference in frequency<sup>25</sup> is of interest in any type of sound reproduction

<sup>25</sup> Shower and Biddulph, *Four. Acous. Soc. Amer.*, Vol. 3, No. 2, Part 1, p. 275, 1931.

where a change or fluxation in the frequency may occur as, for example, phonographs and sound motion pictures. The minimum perceptible change in frequency as a function of the sensation level is shown in Fig. 13.12. It will be seen that the ear is most sensitive to frequency changes at the higher frequencies.

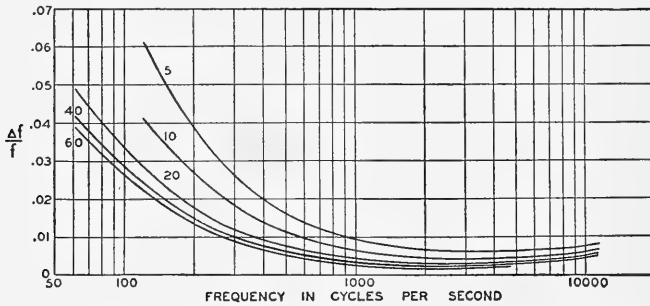

FIG. 13.12. The variation of  $\Delta f/f$  with frequency for various sensation levels.  $\Delta f$  is the change in frequency. Sensation level is level above threshold. (After Shower and Beddulph.)

The minimum time required for a pure tone to excite the ear in order to be sensed as a pure tone is of interest in sound reproduction from the standpoint of the transient response and hangover. It appears that the time is independent of the frequency and is about one twentieth of a second.

The minimum perceptible change in intensity<sup>26</sup> which the ear can detect is of interest in certain types of sound reproduction where the level may change as, for example, fluxations in the voltage gain of an amplifier. The minimum perceptible change in intensity level of pure tones as a function of the frequency for various sensation levels is shown in Fig. 13.13. These characteristics show that the ear is most sensitive to intensity level changes at the higher sensation levels.

**13.17. Timbre (Tone Quality).**—The three physical characteristics which describe a tone are loudness, pitch and timbre. Loudness and pitch have been defined in preceding sections. Timbre is that characteristic of a tone which depends upon its harmonic structure as modified by absolute pitch and total intensity. The harmonic structure is expressed in the number, intensity, distribution and phase relations of its components. Timbre, then, may be said to be the instantaneous cross section of the tone quality. It ranges from a pure tone through an infinite number of

<sup>26</sup> Fletcher, "Speech and Hearing," D. Van Nostrand Co., New York.



changes in complexity up to a pitchless sound such as thermal noise. Work<sup>26A</sup> has been carried out on the subjective measurement of timbre. However, the subject of timbre is more complex than that of loudness and pitch.

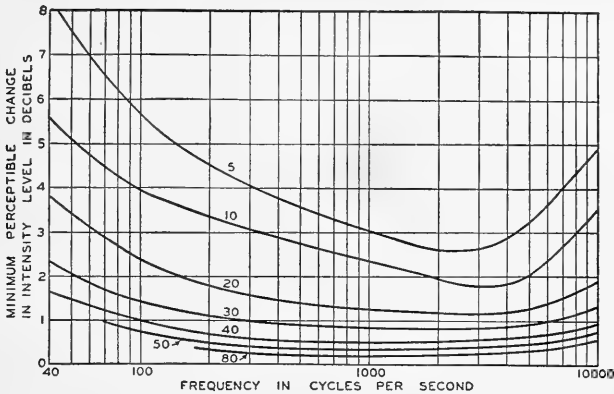

FIG. 13.13. The minimum perceptible change in intensity level of pure tones as a function of the frequency for various sensation levels. Sensation level is level above threshold. (After Fletcher "Speech and Hearing," D. Van Nostrand Co.)

**13.18. Noise in Reproducing Systems.** — Static, hiss, scratch, surface noise and hum are terms which have been introduced to describe various kinds of noises produced by reproducing systems. A few of the types of noises in reproducing systems will be discussed in this section.

In radio broadcasting systems random noise is produced by thermal agitation<sup>27</sup> in conductors, and the small shot effect<sup>28</sup> in vacuum and fluctuating noise is due to atmospheric and man made interference. The energy produced by thermal noise and the small shot effect is proportional to the width of the frequency band. The noise level in a quiet residence is about 30 db. See Sec. 12.2*F*. If the noise generated in the broadcasting system is below 30 db it will not be noticed. Of course, the effects of atmospheric and man made static can be reduced by increased power. Accentuating the high frequency response in transmission and introducing complementary equalization in the receiver will reduce the noise, since the noise is proportional to the band width. For the same reason, frequency modulation also reduces noise in radio reproducing systems.

<sup>26A</sup> Seashore, C. E., "Psychology of Music," McGraw Hill Book Co., New York.

<sup>27</sup> Johnson, J. B., *Phys. Rev.*, Vol. 32, No. 1, p. 97, 1928.

<sup>28</sup> Schottky, W., *Ann. d. Phys.*, Vol. 57, p. 541, 1918.

Hum<sup>29</sup> is another source of noise in radio, phonograph, and sound motion picture reproducing systems because practically all of these systems are operated from the alternating current mains. Hum is due to inadequate filtering in the high voltage supply and inductive and capacitive coupling between the power source and some part of the audio system.

Surface noise or record scratch in phonograph records is due to dirt or foreign particles in the groove and to a granular characteristic of the record material. The record noise generated in a pickup which produces constant output for constant velocity is proportional to the frequency for a narrow frequency band of constant width. It is for this reason that scratch is such a troublesome problem at the high frequencies in record reproduction.

Surface noise in film motion picture reproduction is caused by the modulation of the light falling on the photocell, by dirt, scratches and the natural grain of the film. In the case of film the noise is proportional to the frequency band width. Noise reduction systems increase the ratio of signal to noise in film reproduction by reducing the light to the least possible for the instantaneous modulation.

Superimposed on the average atmospheric pressure are fluctuations caused by thermal velocities of air molecules.<sup>30</sup> This noise places a lower limit upon the air as a transmitting medium. The ear exhibits the greatest sensitivity between 1000 and 6000 cycles. The *rms* sound pressure due to thermal noise in this frequency range is about .00005 dyne per square centimeter. The maximum threshold sensitivity of the ear from Fig. 13.1 is .00008 dyne per square centimeter. In very sensitive ears the threshold at 1000 cycles may be .0002 to .0001 dyne per square centimeter — that is, of the same order of magnitude as thermal noise. For exceptionally good ears a further increase in physiological sensitivity would be useless in the presence of thermal noise. It is interesting to note in passing that the thermal noise of the air molecules acting upon the diaphragm of a very sensitive microphone may be of the same order as the thermal noise generated in the electrical system.

**13.19. Musical Scale.** — An octave is the interval between any two tones whose frequency is 2 : 1.

A tone is a sound giving a definite sensation of pitch.

A scale is a series of tones ascending or descending in frequency by definite intervals suitable for musical purposes.

---

<sup>29</sup> Standards on Radio Receivers, Institute of Radio Engineers, 1938.

<sup>30</sup> Sivian and White, *Jour. Acous. Soc. Amer.*, Vol. 4, No. 4, p. 288, 1933.





## INDEX

- Absorption coefficient**, 275, 279  
**Acoustical, analogies**, 49  
  capacitance, 52, 79  
  elements, 59, 77  
  impedance, 59, 271  
    bridge, 271  
    narrow slit, 78  
    small tube, 78  
  inertance, 51  
  ohm, 59  
  reactance, 59  
  resistance, 50, 59, 77  
    table, 8  
  system, one degree of freedom, 54  
    three degrees of freedom, 61  
    two degrees of freedom, 60  
  wave equation, 4, 7  
**Actuator**, 248  
**Adiabatic**, 5  
**Air chamber**, 150  
**Amplitude of, musical instruments**, 328  
  orchestras, 328  
  speech, 328  
  plane wave, 9  
**Analogies, acoustical**, 49  
  electrical, 49  
  mechanical, 49  
  table, 76  
**Architectural acoustics**, 278  
**Articulation measurements**, 277  
**Artificial, ear**, 270  
  mastoid, 271  
  voice, 271  
**Attenuation of sound in air**, 300  
**Audiometry**, 276  
**Auditory, localization**, 325  
  perspective, 311  
**Baffles, loud speaker**, 127  
  microphone, 194  
**Bars, longitudinal vibration**, 44  
  torsional vibration, 46  
  transverse vibration, 38  
    clamped,  
      clamped, 40  
      free, 38  
    free free, 39  
    supported, 40  
**Batteryless telephone**, 213  
**Beats**, 325  
**Bel**, 15  
**Binaural reproduction**, 310  
**Bipolar telephone receiver**, 226  
**Broadcasting, of sound**, 314  
  studios, 307  
  system, 314  
**Cabinet, back enclosed**, 130  
  reproducers, 129  
**Calibration of microphones**, 245  
  directional characteristic, 250  
  electrical impedance characteristic, 253  
  nonlinear distortion characteristic, 251  
  phase distortion characteristic, 252  
  response frequency characteristic, 245  
    pressure response, 245  
      electrostatic actuator, 248  
      pistonphone, 246  
      thermophone, 247  
    field response, 249  
      Rayleigh disk, 249  
  transient response characteristic, 253  
**Carbon microphone**, 172  
  double button, 175  
  single button, 172  
**Cathode ray tube, for measurement of**,  
  directional characteristic, 250  
  nonlinear characteristic, 264  
  phase characteristic, 252  
  response characteristic, 257  
  transient characteristic, 268  
**Cellular horn**, 32, 167  
**Circular, clamped plate**, 42  
  membrane, 40

- Circular, ring source, 28  
 surface source, 29
- Collection of sound, 303  
 broadcasting studios, 307  
 directional microphones, 189, 203, 213, 305  
 nondirectional microphones, 185, 305  
 reverberation time, 274, 280, 290, 308  
 synthetic reverberation, 309
- Combination tones, 331
- Compliance, mechanical, 52
- Compound horn, 168
- Compressibility, 5
- Condensation, 6
- Condenser, driving system, 107  
 microphone, 177
- Cone, (see diaphragm)
- Conical horn, 88, 90
- Connectors, exponential, 94
- Consonant sounds, 277, 318
- Corrective networks, 62
- Crystal, microphone, 180  
 diaphragm actuated, 182  
 direct actuated, 182  
 pickup, 235  
 telephone receiver, 230
- Curved, line source, 25  
 surface source, 32
- Cutoff frequency of, exponential horn, 89  
 filter, 70
- Cycle, 3
- Decibels, 15**
- Density, various materials, table, 8, 48
- Diaphragms, loud speaker, 142, 171
- Difference tones, 331
- Diffraction, 17
- Dimensions, table, acoustical, 76  
 electrical, 76  
 mechanical, 76
- Directional, characteristics, circular surface, 29  
 curved surface, 32  
 double source, 21  
 exponential horn, 31  
 line, circular, 28  
 curved, 25  
 straight, 24
- piston, 29  
 efficiency, 221  
 microphones, 189, 203, 213, 305
- Direct radiator loud speaker, (see loud speaker)
- Dispersion of sound, 279  
 absorption in passing through air, 300  
 articulation, 281  
 general announce system, 296  
 intercommunicating system, 297  
 noise, 291  
 nonlinear distortion in plane wave, 302  
 paging system, 296  
 power requirements, 290  
 public address system, 292  
 radio receiver, operating in, automobile, 290  
 living room, 298  
 reverberation time, studio, 308  
 theatre, 290  
 sound, absorption, 279  
 table, 281  
 motion picture system, 282  
 re-enforcing system, 286  
 transmission through partitions, 301
- Dissipation, 56
- Distortion, nonlinear, ear, 323  
 loud speaker, 136, 156, 262  
 microphone, 223, 251  
 phonograph, 238  
 subharmonic, 137, 162
- Doppler effect, 16
- Double source, 21
- Driving systems, 101  
 condenser, 107  
 electrodynamic, 101  
 electromagnetic, 102  
 piezoelectric, 109
- Dynamic, loud speaker, (see direct radiator loud speaker)  
 microphone, 183  
 pickup, 238  
 telephone receiver, 230
- Dyne, 6
- Ear, artificial, 270**  
 mechanism, 317  
 response characteristics, 319

- Efficiency, direct radiator, 112  
   horn, 145  
 Electrical, abohm, 58  
   analogies, 49  
   elements, 49, 50, 51, 53  
   impedance, 58  
   reactance, 58  
   resistance, 50, 58  
   system, one degree of freedom, 54  
     three degrees of freedom, 61  
     two degrees of freedom, 60  
 Electrodynamical driving system, 101  
 Electromagnetic driving system, 102  
 Elements, acoustical, 50, 51, 52, 53  
   electrical, 49, 50, 51, 53  
   mechanical, 50, 51, 52, 53  
 Energy density, sound, 14  
 Equation, continuity, 4  
   motion, 5, 57  
   wave, 4  
 Exponential horn, 31, 89  
   directional characteristics, 31  
   finite, 91  
   infinite, 89  
   multiple flare, 96  
**Feedback**, 135  
 Field structure, loud speaker, 143, 171  
 Filters, (see wave filters)  
 Frequency, 3  
   fundamental, 3  
   range of, music, 326  
     speech, 326  
   resonant, 59  
**General announce system**, 296  
 Generators of sound, (see loud speakers)  
   sirens, 242  
   whistles, 243  
 Geophysical, (see seismic)  
 Gyration, radius of, 38  
**Harmonic**, 3  
 Head diffraction, 17, 325  
 Hearing, aids,  
   carbon, 241  
   vacuum tube, 241  
   mechanism, 317  
   response characteristics, 319  
   nonlinearity, 323  
 Helmholtz resonator, 64  
 Horn, cellular, 32  
   direct radiator combination, 133  
   directional characteristics, 31, 32  
   equation, 86  
   finite, characteristics, 92  
     conical, 90  
     exponential, 91  
   general, 85  
   infinite, conical, 88  
     exponential, 89  
     impedance, 89  
     parabolic, 87  
   loud speaker, (see loud speaker horn)  
   manifold sections, 96  
   multiple flare, 96  
 Hot wire microphone, 212  
**Impedance**, acoustical, 59  
   table, 8  
   bridge, 271  
   ear, 270  
   electrical, 58  
   horns, 92  
   mechanical, 59  
   motional, 102  
   orifice, 84  
   oscillating sphere, 83  
   pipe, 84, 85  
   piston, 80  
   pulsating sphere, 81  
   slit, 78  
   tube, 78  
 Inductance, 50  
 Inductor, microphone, 185  
   telephone receiver, 232  
 Inertance, 51, 79  
 Inertia, 51  
 Intelligibility, 277  
 Intensity of sound, 14  
 Intercommunicating system, 297  
**Kinetic energy**, 55  
 Labyrinth, 132  
 Lapel microphone, 212

- Larynx, 318,  
 artificial, 318
- Line microphone, 214
- Longitudinal vibration of bars, 44
- Loudness, 320
- Loud speaker, direct radiator, 111  
 baffles, 127  
 cabinet back enclosed, 130  
 cabinet open, 129  
 diaphragm, 142  
 double coil, double cone, 123  
   single cone, 121  
 efficiency, 112  
 feedback, 135  
 field structures, 143  
 horn combination, 135  
 labyrinth, 132  
 mechanical networks, 124  
 multiple, single cone, single coil, 119  
 nonlinear distortion, 136, 262  
 phase inverter, 131  
 power output, 113  
 single coil, double cone, 120  
   single cone, 112  
 transient response, 138, 268  
 voice coils, 142, 171
- horn, 145,  
 amplitude of the diaphragm, 164  
 compound, 168  
 compressed air, 242  
 diaphragms, 171  
 efficiency, 145  
   air chamber, effect of, 150  
   generator, effect of, 153  
   initial, 146  
   mass, effect of, 149  
   temperature, effect of, 155  
 field structures, 171  
 multiple horn, multiple channel, 167  
   single channel, 169  
 nonlinear distortion, 156, 262  
   air, chamber, effect of, 157  
   gap, effect of, 161  
   subharmonic, 162  
   suspension, effect of, 160  
   throat, effect of, 156  
 power handling capacity, 163, 164  
 single horn, single channel, 164  
 voice coil, 163, 171  
 walls, absorption, 171  
   vibration, 171  
 operating in, automobile, 299  
   living room, 298  
   theatre, 282  
 testing, (see testing of loud speakers)
- M**asking, 322
- Measurement of, absorption coefficient,  
 275  
 acoustic impedance, 271  
 loud speakers, 253  
 microphones, 245  
 noise, 273  
 reverberation time, 274  
 telephone receivers, 269  
 transmission coefficient, 276
- Measurements, 245
- Mechanical, analogies, 49  
 compliance, 52  
 elements, 53  
 impedance, 59  
 ohm, 59  
 phonograph, 233  
 reactance, 59  
 resistance, 50, 59  
 system, one degree of freedom, 54  
   three degrees of freedom, 61  
   two degrees of freedom, 60  
 vibrating systems, 36
- Membrane, circular, 40
- Microphone, batteryless telephone, 213  
 calibration, (see calibration of micro-  
 phones)  
 directional efficiency, 221  
 high sensitivity, 224  
 highly directional, 213  
   line type, 214  
   simple, 214  
   with, delay, 216  
     pressure gradient, 218  
   parabolic reflector, 213  
   ultradirectional, 220  
 hot wire, 212  
 lapel, 212  
 motional impedance, 224  
 nonlinear distortion, 223



- Microphone, pressure, 172  
   carbon, double button, 175  
   single button, 172  
   condenser, 177  
   crystal, (see piezoelectric)  
   inductor, 185  
   moving, coil, 185  
   conductor, 183  
   piezoelectric, 180  
     diaphragm actuated, 182  
     direct actuated, 182  
   ribbon, 186  
   sound power, 213  
   thermal noise, 225  
   throat, 212  
   transient response, 224  
   unidirectional, 203  
     combination pressure and velocity,  
       204  
     directional pattern, 210  
     phase, effect of, 207  
     sensitivity, effect of, 206  
   phase shifting, 210  
   velocity, 189  
     pressure gradient, 189  
     velocity, 194  
     wind screening, 222
- Minimum perceptible differences, 331
- Modes of vibration of,  
   bars, longitudinal, 44  
   torsional, 46  
   transverse, 38  
   membrane, circular, 40  
   pipes, 47  
   plate, circular, 42  
   strings, 36
- Modulation, 324
- Motion picture, screens, 285  
   sound system, 282, 312
- Musical, instruments, (electrical)  
   carillon, 240  
   organ, 240  
   piano, 240  
   voder, 240  
   scales, 334  
   equally tempered, 335  
   natural, 335  
   terms, 334
- Networks, corrective, 62  
   mechanical, (see loud speaker)  
   resistance, 67
- Nodal lines, membranes, 40  
   plates, 42
- Nodes, 37
- Noise, 273  
   in reproducing systems, 333  
   surface, 333  
   thermal, 333
- Nondirectional microphones, 172, 305
- Nonlinear distortion, effect upon quality,  
   328  
   loud speakers, 136, 156  
   microphones, 223  
   plane waves, 302  
   ear, 323
- Octave, 4
- Ohm, acoustical, 59  
   electrical, 58  
   mechanical, 59
- One degree of freedom, acoustical, 54  
   electrical, 54  
   mechanical, 54
- Orifice, circular, impedance, 84
- Oscillating sphere, impedance, 83
- Paging systems, 296
- Parabolic reflector, 213
- Particle velocity, plane wave, 9  
   spherical wave, 12  
   stationary wave, 13
- Period, 3
- Periodic quantity, 3
- Phase, effect of, 324  
   in, loud speakers, 167, 267  
   microphones, 195, 207, 252  
   inverter loud speaker, 131  
   measurement, 252, 267  
   shifting microphones, 210  
   spherical wave, 10
- Phonograph, distortion, 238  
   mechanical, 233  
   pickup, 239  
   crystal, 235  
   dynamic, 238  
   magnetic, 236

- Phonograph, reproducing system, 315  
 " Pi " networks, 69  
 Piezoelectric, driving system, 109  
   microphone,  
     diaphragm actuated, 180  
     direct actuated, 182  
   pickup, 235  
   telephone receiver, 230  
 Pipes, closed, 47, 84  
   open, 47, 84  
 Piston, vibrating, directional, 29  
   impedance, 80  
 Pistonphone, 246  
 Pitch, 322  
 Plane waves, 7  
   amplitude, 9  
   particle velocity, 9  
   pressure, 9  
 Plate, circular clamped, 42  
 Point source, 19  
 Poisson's ratio, table, 48  
 Potential energy, 55  
 Power, handling capacity of loud speakers, 113, 163, 164  
   output of, loud speakers, 113, 163, 164  
   musical instruments, 328  
   speech, 328  
 Pressure, gradient microphone, 189  
   microphone, 172  
   sound, effective, 6  
     instantaneous, 6  
     maximum, 6  
     peak, 6  
 Public address system, 292  
 Pulsating sphere, impedance, 81  
  
 Quantities, table, acoustical, 76  
   electrical, 76  
   mechanical, 76  
  
 Radiation resistance, 80, 81, 83  
 Radio, receiver operating in, automobile, 299  
   living room, 298  
   sound reproducing system, 314  
 Rayleigh disk, 249  
 Reactance, acoustical, 59  
   electrical, 58  
   mechanical, 59  
 Reflector, 213  
 Refraction, 17  
 Resistance, acoustical, 59  
   electrical, 58  
   mechanical, 59  
   networks, 67  
 Resonant frequency, 59  
   bars, longitudinal, 44  
     torsional, 46  
     transverse, 38  
   definition, 59  
   membrane, circular, 40  
   one degree of freedom, 54  
   plate, circular, 42  
   pipes, 47  
   string, 36  
 Response characteristics, (see ears, loud speakers, microphones, telephone receivers, testing)  
 Reverberation time, 274, 279, 290, 308  
 Ribbon microphone, 186, 194  
 Rochelle salt, (see piezoelectric)  
 Rotating microphone, 260  
  
 Screen, motion picture, 285  
 Seismic detectors, 243  
 Sirens, 242  
 Slit, narrow, 78  
 Sound, 2  
   distribution loud speaker, 143  
   energy density, 14  
   intensity, 14  
   pressure, effective, 6  
     instantaneous, 6  
     maximum, 6  
     peak, 6  
 Source, circular, ring, 28, 29  
   surface, 29  
   curved, line, 25  
   surface, 32  
   double, 21  
   exponential horn, 31  
   point, 19  
   straight line, 24  
 Speech, artificial larynx, 318  
   frequency range, 326  
   mechanism, 318

- Speech, power, 328  
vocoder, 319
- Sphere, oscillating, 83  
impedance, 83  
pulsating, 81  
impedance, 81
- Spherical wave, particle velocity, 12  
phase angle, 12  
pressure, 11
- Stationary wave, 13
- Strings, 36
- Subharmonics, 3  
distortion, 137, 162
- Supersonics, 243
- Symbols, table, acoustical, 76  
electrical, 76  
mechanical, 76
- Synthetic reverberation, 309
- Systems, driving, 77
- "T"** networks, 69
- Table, absorption coefficients, 281  
acoustic resistances, 8  
decibels, power and voltage ratios, 16  
densities, 8, 48  
dimensions of quantities, 76  
musical scales, 335  
noise, in various locations, 293  
reduction through various structures, 302  
Poisson's ratios, 48  
quantities; electrical, mechanical and acoustical, 76  
symbols; electrical, mechanical and acoustical, 76  
units, 76  
velocities of sound, 8  
Young's moduli, 48
- Telephone, 309  
receiver, bipolar, 226  
crystal, 230  
dynamic, 230  
inductor, 232  
testing, (see testing of telephone receivers)
- Testing of, loud speakers, directional characteristic, 261
- efficiency frequency characteristic, 265
- impedance frequency characteristic, 268
- nonlinear distortion characteristic, 262
- phase distortion characteristic, 267
- response frequency characteristic, 254  
apparatus, 255  
automobile measurements, 261  
calibration of equipment, 258  
living room measurements, 261  
response, definition, 254  
theatre measurements, 261  
subjective measurements, 269  
transient response characteristic, 268
- telephone receivers, artificial, ear, 270  
mastoid, 271  
objective measurements, 270  
subjective measurements, 269
- Thermal noise in microphones, 225
- Thermophone, 247
- Three degrees of freedom, acoustical, 61  
electrical, 61  
mechanical, 61
- Throat microphone, 212
- Timbre, 332
- Torsional vibration of bars, 46
- Transducer, 4
- Transient response, loud speakers, 138, 268  
microphones, 224, 253
- Transmission, in tubes, 97  
one medium to another, 98  
through partitions, 276, 301
- Transverse vibration, bars, 38  
strings, 37
- Tubes, lined, 100  
small, 78  
transmission in, 97
- Tuning fork, 39
- Two degrees of freedom, acoustical, 61  
electrical, 60  
mechanical, 60
- Ultradirectional microphone, 220
- Unidirectional microphone, 203

- Unidirectional microphone, combination  
velocity and pressure, 203, 204  
phase shifting, 210
- Units, table, acoustical, 76  
electrical, 76  
mechanical, 76
- Velocity, microphone, 189  
potential, 7  
of sound, 7  
table, 8
- Vibrating piston, directional, 29  
impedance, 80
- Vibration, longitudinal, bars, 44  
pipes, 47  
torsional, bars, 46  
transverse, bars, 38  
strings, 36
- Vibrato, 325
- Viscosity, 77, 78
- Vocoder, 319
- Voder, 240
- Voice coils, loud speaker, 142, 171
- Vowel sounds, 318
- Wave**, equation, 4, 6, 7  
filters, band, elimination, 69, 74  
pass, 69, 73  
high pass, 69, 72  
low pass, 69, 70  
response, 70
- plane, 7  
amplitude, 9  
particle velocity, 9  
pressure, 9
- spherical, 10  
particle velocity, 12  
phase angle, 12  
pressure, 11  
stationary, 13
- Wavelength, 3
- Wind screening of microphones, 222
- Young's modulus, table, 48
- Zone plate, 18





